



FAHRZEUGEINRICHTUNGEN
FITTINGS FOR COMMERCIAL VEHICLES



MERCEDES-BENZ VITO





TECHNOLOGIE

GALVANNEALED STAHL

Galvannealed Blech ist eine Variante von feuerverzinktem Blech. Das Produkt unterliegt einem Feuerbeschichtungsprozess und wird bis ca. 550 °C erhitzt. Dies ermöglicht es dem Zink mit dem Stahlblech eine Legierung einzugehen. Das Ergebnis ist eine Beschichtung mit einer gleichförmigen, feinkörnigen Kristallstruktur an der Beschichtungsoberfläche und einer **sehr hohen Oberflächenqualität und Korrosionsbeständigkeit**.

Dieses Verfahren ist ideal für Automotive Anwendungen. StoreVan hat diese Technik nun auch im Bereich Nutzfahrzeugeinrichtungen implementiert.

DAS VERFAHREN DER KATHODISCHEN ACRYL-TAUCHLACKIERUNG

Die kathodische Acryl-Beschichtung ist eine Oberflächenbehandlung, die den einzelnen Teilen der Einrichtung eine **extrem hohe Korrosionsbeständigkeit** verleiht. Das Tauchverfahren gewährleistet eine **gleichmäßige Beschichtung** und einen lang anhaltenden Schutz egal gegen welche Stoffe. Das Acrylharz schützt den Lack bei direkter Belichtung durch die Witterung gegen Ausbleichen und gegen Veränderungen der Korrosionsbeständigkeit.

- Korrosionsbeständigkeit von über 500 Stunden (ASTM D1735 Luftfeuchtigkeit)
- Ausgezeichnete Härte mit einem Mindestrating von 2H



StoreVan ist weltweit der einzige Hersteller von Nutzfahrzeugeinrichtungen, der mit dieser Technologie arbeitet.

StoreVan is the sole LCV's equipment manufacturer worldwide to make use of this technology.



STORE VAN ORANGE PLANET

Nachhaltigkeit und ökologische Entwicklung sind Themen von großem, aktuellem Interesse, entstanden durch das steigende Bewusstsein, dass auf die Umweltbalance aufgrund der zyklischen Veränderungen und Erneuerungen geachtet werden muss.

STORE VAN ORANGE PLANET

Environmental sustainability and eco-compatible development are topics of great interest and relevance, arising from the growing awareness that it is important to pay attention to the environmental balance.

TECHNOLOGIES

GALVANNEALED STEEL

Galvannealed sheet is a variant of hot-dip galvanized sheet. The product is subject to a hot-dip galvanization process and subsequently heated to approximately 550°C, combining the zinc with the sheet surface to make an alloy with iron. The result is a uniform zinc coating with a fine-grained crystalline structure along with a **much higher surface quality and corrosion resistance**. This process is ideal for automotive applications. StoreVan has introduced and implemented this technology in the commercial vehicles equipment field.

CATHODIC DIP PAINTING WITH ACRYLIC RESIN

Cataphoresis painting is a paint surface treatment able to give the equipment elements a **remarkable resistance to corrosion**; characterized by **uniform deposit** of an acrylic resin on the element surface, it ensures long lasting, high protection against chemical agents and other types of surface attacks. The acrylic resin allows a direct exposure to atmospheric agents without altering its technical features. This process ensures an increased protection against rust.

- Corrosion resistance of more than 500 hours (humidity ASTM D1735)
- Excellent hardness with a minimum rating of 2H



FLEXIBLES BEFESTIGUNGSSYSTEM

FLEXIBLE FIXING SYSTEM

DIE FLEXIBILITÄT UND DAUERHAFTIGKEIT DER STORE VAN TRANSPORTEREINRICHTUNGEN

Store Van benutzt zur Befestigung der Transporterregale am Fahrgestell des Nutzfahrzeuges ein spezielles Schienensystem und sorgt damit für eine besonders flexible Positionierbarkeit der Module und eine maximale Nutzung der Innenräume des ausgestatteten Transporters.

Bei diesem System werden Bügel benutzt, die in der Gesamtlänge der Schiene gleiten, anstatt direkt an den Verstärkungen des Fahrgestells angenietet zu sein, was beim Entwurf der Transportereinrichtung grundsätzlich zu einer starren Raumnutzung zwingt. Die von Store Van verwendete Schiene wird an die vertikalen Pfosten der mobilen Werkstatt befestigt und hat die doppelte Funktion einer gleichmäßigen Verbindung der Transporterregale am Fahrzeugrahmen und einer homogenen Verteilung aller dynamischen Kräfte, denen die Einrichtung während der Fahrt ausgesetzt ist.

Die Befestigungsbügel für die Verbindung der Schiene am Modul besitzen ein spezielles Gelenk, das die bei der Fahrt verursachten Vibrationen dämpft, indem es sich den Torsionsbewegungen des Fahrgestells anpasst, vor allem beim Kurvenfahren.

Dieses System bietet beim Entwurf unserer Transportereinrichtungen eine erhebliche Gestaltungsfreiheit, wobei in jedem Fall hohe Sicherheits-, Stabilitäts- und Dauerhaftigkeitsstandards garantiert werden.

Bei allen unseren Befestigungssystemen können für die Module Schnellankupplungs- und -loskupplungssysteme mit Feststellgriffen eingesetzt werden, die eine werkzeuglose Demontage der Einrichtung ermöglichen. Dadurch kann das Regal Ihrer mobilen Werkstatt, wie in der RICHTLINIE 2014/47 EU, KAP. 1, Artikel 3, Absatz 5 beschrieben, als transportiertes Material oder als Hilfsmittel für die Sicherheit der nicht dauerhaft am Fahrzeug befestigten Ladung erklärt werden.

FLEXIBILITY AND DURABILITY OF STORE VAN EQUIPMENT

Store Van uses a special rail anchoring system to secure shelving units for vans to the chassis of your vehicle, improving the flexibility of module arrangement and maximising the internal spaces of your van.

This system is based on brackets sliding all along the rail rather than being riveted to chassis reinforcements, thus offering great flexibility in the management of internal spaces. The Store Van rail is secured to the uprights of your mobile workshop and has a two-fold function: it connects shelving units uniformly to the frame of your vehicle, and it evenly distributes all the dynamic forces your van equipment is subject to while travelling. Special vibration damping joints, fitted on the brackets connecting the rail to the module, absorb the torsional vibration applied on the chassis especially when driving on a curve.

Thanks to this system, our fittings for vans can be designed with maximum freedom, always ensuring high safety, stability and durability standards.

Our anchoring systems are fitted with quick locking/unlocking devices with adjustable handles, so users can remove the fittings with no need of tools. Hence the shelving units of your mobile workshop may be considered as transported goods or load securing fittings not permanently fixed to the vehicle, in compliance with Directive 2014/47EU, Chapter 1, Article 3, Item 5.



ZERTIFIZIERUNGEN CERTIFICATIONS

ZERTIFIZIERTE PRODUKTION

- Nach ISO 9001:2015 zertifiziert.
- Erfolgreicher CRASH TEST durchgeführt nach ECE-R17 mit einer Aufprallgeschwindigkeit von 50 Km/h.
- GS-Zertifizierung für Inneneinrichtungen und Laderampen.
- GS-Zertifizierung für Dachträger und Leiterträger.

CERTIFIED PRODUCTION

- ISO 9001:2015 certified.
- Brilliantly passed the CRASH TEST carried out according to the most recent European regulations ECE-R17 with impact at 50 Km/h.
- GS certification for interior fittings and loading ramps.
- GS certification for roof and ladder racks.

CRASH TEST
ECE-R17



Grundlage für den sicheren Schutz von Fahrzeugen

Base for the safe protection of vehicles

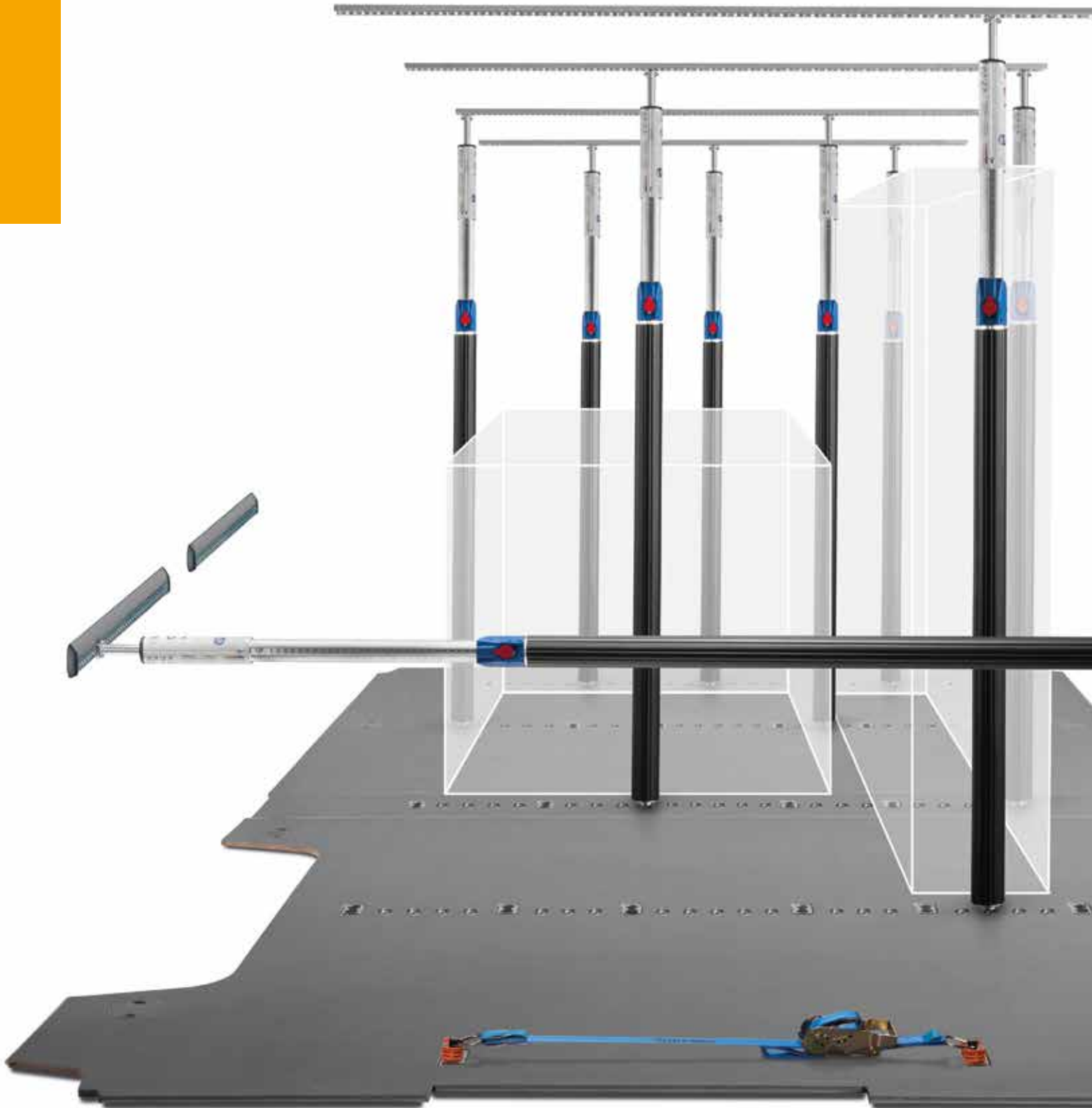

LADUNGSSICHERUNG FÜR TRANSPORTER UND SICHERE BEFESTIGUNG DER WAREN

Durch die Umsetzung der Richtlinie 2014/47/EU wird eine Intensivierung der Kontrollen an Kraftfahrzeugen für die Güterbeförderung der Klassen N2 und N3 und eine aufmerksamere Kontrolle der Ladungssicherung erfolgen. Die Richtlinie ermöglicht es den Mitgliedsstaaten, Fahrzeuge, die über den Anwendungsbereich hinausgehen, wie z.B. Nutzfahrzeuge der Klasse N1, technischen Kontrollen zu unterziehen, sowie weitere Aspekte des Transports und der Straßenverkehrssicherheit zu kontrollieren.

SCHUTZSYSTEM DES LADERAUMS UND LADUNGSSICHERUNG

Das neue integrierte Transporter-Schutzsystem von Store Van folgt den Leitlinien der neuen Richtlinie 2014/47/EU und erlaubt eine **flexible und sichere Befestigung** der Ladung an den Ladeflächen und Innenwänden des Fahrzeugs.

Mit den „Airline“ Festhaltekomponenten und dem Einbau zahlreicher Zubehörteile wie Riemen, Netze und teleskopische Spannstangen kann der Fahrzeugbenutzer seine Festhalteplattform einfach, ergonomisch und in Entsprechung der europäischen Richtlinien gestalten.

Das System umfasst die folgenden Bestandteile:

- Mehrschichtige Bodenplatten für Transporter mit Phenolharzverleimung, mit eingelassenen Aufnahmen für die Originalverankerungen des Fahrzeugs und mit zusätzlichen bodenplattenflächigen Verankerungen (S. 10) mit einer Zugkraft von 200 daN;
- am Fahrgestell verankerte „Airline“ Aluminiumschienen (S. 11);
- hochflexible und hochresistente Polypropylenpaneele für den internen Schutz der Karosserie vor Stößen (S. 8).

DAS ANBRINGEN DES NEUEN SCHUTZSETS SORGT FÜR EINE LANGE REIHE VON VORTEILEN:

- Der Fahrzeugbenutzer kann die Ladung schon mit den Zurrgurten sicher an den „Airline“ Schienen befestigen.
- Das integrierte Befestigungsset hält die Karosserie länger in gutem Zustand.
- Das Schutzsystem verleiht einen Mehrwert, der schon auf dem Markt der Neufahrzeuge sehr wichtig erscheint und bei Gebrauchtfahrzeugen, die normalerweise Karosserieschäden aufweisen, sogar von grundlegender Bedeutung ist.



VAN LOAD SECURING AND CARGO RESTRAINT

Transposition of directive 2014/47/EU will intensify control of N2 and N3 category transport vehicles and cargo securement enforcement. Under this Directive, the Member States can subject vehicles that are beyond the scope of the Directive, such as N1 category vehicles, to technical inspections, and also monitor other transport and road safety aspects.

CARGO AREA PROTECTION SYSTEM AND CARGO RESTRAINT

The new Store Van integrated system for van protection follows the guidelines of Directive 2014/47/EU while making the **anchoring of the cargo to the van floor and walls flexible and safe.**

With the use of „Airline“ securing components and integration of many different accessories such as belts, nets and telescopic load restraining bars, final users may configure their cargo platform easily and cheaply and in conformity with the European Directive.

The system uses:

- phenolic resin plywood floor panels, arranged to fit original anchoring fittings and additional 200 daN strength lashing points (page 10), flush with the floor panel;
- aluminium „Airline“ bars anchored to the chassis (page 11);
- highly flexible and resistant polypropylene panelling to protect the internal body shell from accidental impacts (page 8).

THE NEW LOAD SECURING SYSTEM OFFERS NUMEROUS ADVANTAGES:

- users can safely secure the load to the „Airline“ bars with load restraining belts;
- the integrated load securing system extends the body's good condition over the time;
- the protection system offers new added value, an important economic aspect for a new vehicle and a fundamental characteristic for a second-hand vehicle, that is usually exposed to damage.

SAFETY CROSS: Fixierpunkte in Längs- und Querrichtung nach Anfrage.
SAFETY CROSS: longitudinal and transversal fixing points upon request.

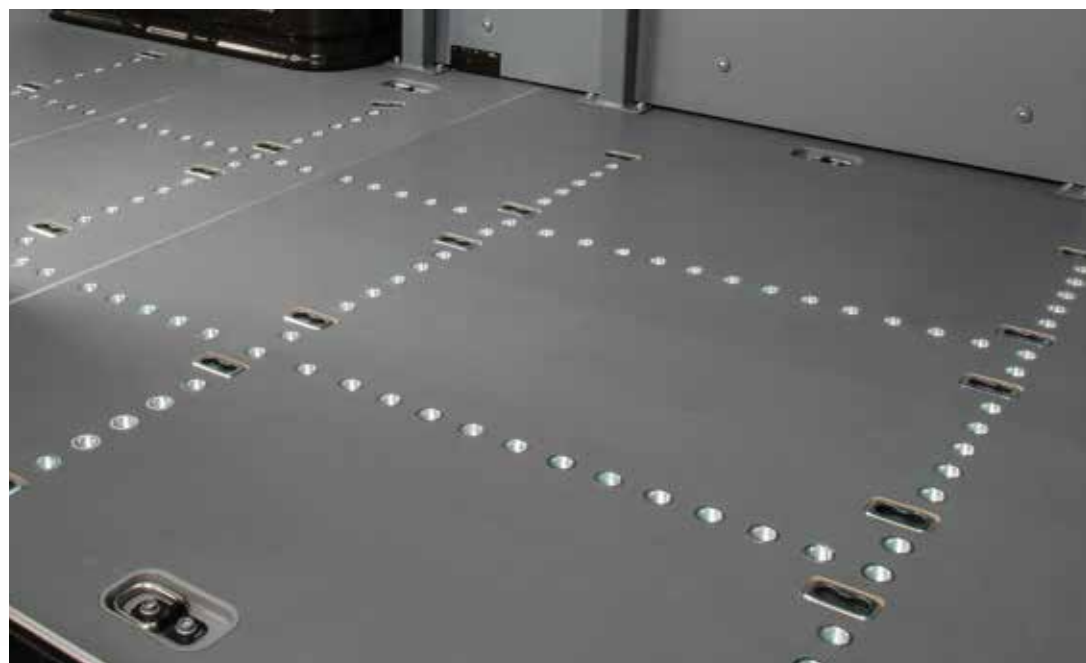

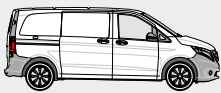

- Seitenverkleidungen für Fahrzeug mit rechter Schiebetür und Seitenwänden aus Vollblech.
- Linings for right side door vehicle with metal sheet sidewalls.

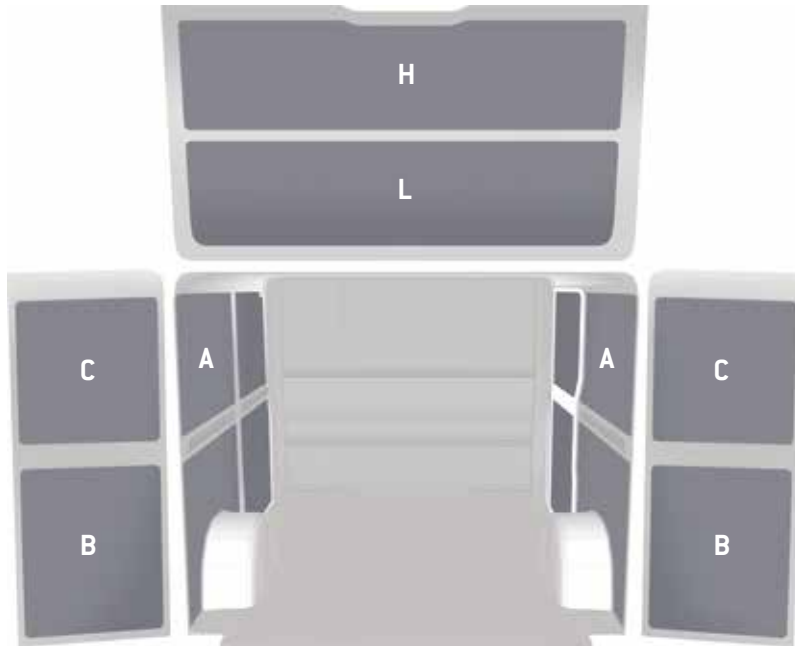

HONEYCOMB PANEL - A

- Seitenverkleidung aus Polypropylen für:
 - linke Seitenwand
 - rechte Seitenwand und Schiebetür
- Polypropylene linings for:
 - LH sidewall
 - RH sidewall and sliding door

HONEYCOMB PANEL - B / H

- Seitenverkleidung aus Polypropylen für:
 - unteren Teil der Heckflügeltüren
- Polypropylene linings for:
 - lower part of rear hinged doors

HONEYCOMB PANEL - C / L

- Seitenverkleidung aus Polypropylen für:
 - oberen Teil der Heckflügeltüren
- Polypropylene linings for:
 - upper part of rear hinged doors

FAHRZEUG VEHICLE	SEITENVERKLEIDUNGEN LININGS				
	A	B	C	H	L
	ART. NR. / ITEM NO.	ART. NR. / ITEM NO.	ART. NR. / ITEM NO.	ART. NR. / ITEM NO.	ART. NR. / ITEM NO.
Fahrzeugtyp - Model Kompakt - Compact ^A	VT 10H1 A0 7,64 kg	VT DR00 A0 1,31 kg	VT DRH1 A0 1,29 kg		
Fahrzeugtyp - Model Kompakt - Compact ^B	VT 10H1 A0 7,64 kg			VT DR00 E0 0,92 kg	VT DRH1 E0 1,60 kg
Fahrzeugtyp - Model Lang - Long ^A	VT 1LH1 A0 8,84 kg	VT DR00 A0 1,31 kg	VT DRH1 A0 1,29 kg		
Fahrzeugtyp - Model Lang - Long ^B	VT 1LH1 A0 8,84 kg			VT DR00 E0 0,92 kg	VT DRH1 E0 1,60 kg
Fahrzeugtyp - Model Extralang - Extra Long ^A	VT 20H1 A0 9,36 kg	VT DR00 A0 1,31 kg	VT DRH1 A0 1,29 kg		

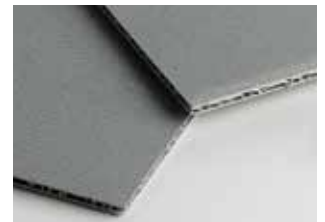

^A Heckflügeltüren - Rear hinged doors
^B Heckklappe - Rear gate



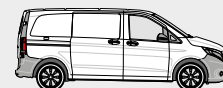

- Bodenplatte für Fahrzeug mit rechter Schiebetür und Seitenwänden aus Vollblech.
- Flooring for right side door vehicle with metal sheet sidewalls.

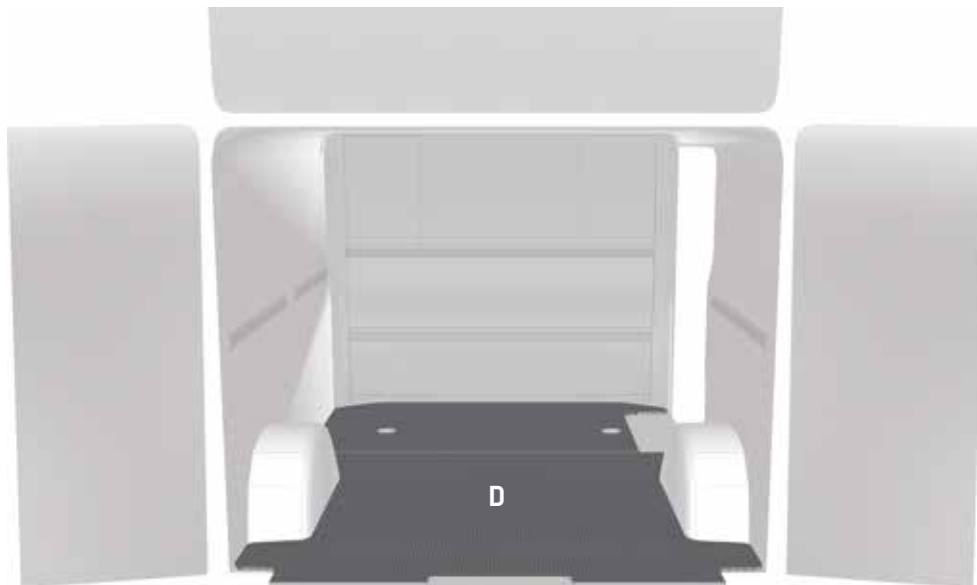

WOOD FLOOR - D

- Bodenplatte aus Multiplex mit Phenolbeschichtung, Stärke 9 mm, für das Originalverankerungssystem des Fahrzeugs vorgebohrt.
- 9 mm thick wooden flooring with phenolic coating set for the vehicle original anchoring system

KASTENWAGEN - PANEL VAN
MERCEDES-BENZ VITO
WF

FAHRZEUG VEHICLE	BODENPLATTE 9 mm 9 mm FLOORING
	D
	ART. NR. / ITEM NO.
Fahrzeugtyp - Model Kompakt - Compact	VT 10D1 A0 24,98 kg
Fahrzeugtyp - Model Lang - Long	VT 11D1 A0 27,72 kg
Fahrzeugtyp - Model Extralang - Extra Long	VT 20D1 A0 30,80 kg





- Bodenplatte für Fahrzeug mit rechter Schiebetür und Seitenwänden aus Vollblech.
- Flooring for right side door vehicle with metal sheet sidewalls.

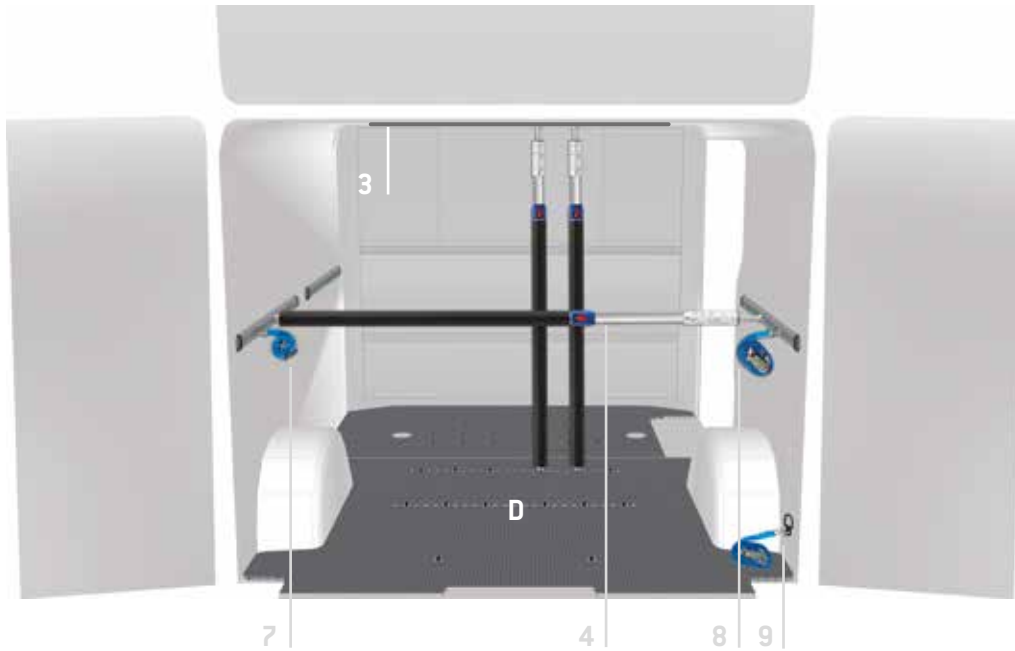

SAFETY FLOOR - D

- Bodenplatte 9 mm aus phenolbeschichtetem Holz mit zusätzlichem Einzelzurrpunktensystem.
- 9 mm phenol faced plywood flooring with additional lashing points

FAHRZEUG VEHICLE	BODENPLATTE 9 mm FLOORING 9 mm
	D
	ART. NR. / ITEM NO.
Fahrzeugtyp - Model Kompakt - Compact	VT 10G1 A0 27,26 kg
Fahrzeugtyp - Model Lang - Long	VT 1LG1 A0 29,93 kg

Die Bodenplatte muss auf den Fahrzeugboden aufgeklebt sein.
The floor must be glued to the vehicle

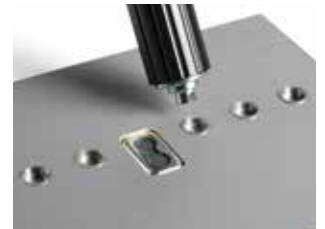

- Silikonklebstoff für Bodenplatten.
- Silicone glue for flooring.

ART. NR. / ITEM NO. V22585

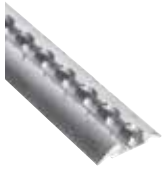
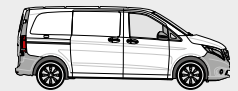

- Horizontale Aluschiene.
- Horizontal aluminium bar.

1

ART. NR. / ITEM NO.

- V18029 05** Länge - Length 500 mm
- V18029 10** Länge - Length 1000 mm
- V18029 15** Länge - Length 1500 mm
- V18029 20** Länge - Length 2000 mm
- V18029 25** Länge - Length 2500 mm



- Teleskopische Spannstange.
- Telescopic load restraining bar.

4

ART. NR. / ITEM NO.

- V22149** Länge - Length 650-900 mm
- V22734** Länge - Length 850-1100 mm
- V22735** Länge - Length 1050-1300 mm
- V22131** Länge - Length 1250-1750 mm
- V22017** Länge - Length 1550-2050 mm
- V22086** Länge - Length 2000-2500 mm



- Endstück aus Kunststoff für Aluschiene Serie V18029.
- Plastic end cap for bar series V18029.

5

ART. NR. / ITEM NO.

V22106



- Horizontale Aluschiene.
- Horizontal aluminium bar.

2

ART. NR. / ITEM NO.

- V18025 05** Länge - Length 500 mm
- V18025 10** Länge - Length 1000 mm
- V18025 15** Länge - Length 1500 mm
- V18025 20** Länge - Length 2000 mm



- Zurrring.
- Ring stud fitting.

6

ART. NR. / ITEM NO.

V225820



- Zurrgurt mit Hebelspannschloss 2500+500.
- Load restraining belt with clamp 2500+500.

7

ART. NR. / ITEM NO.

V22136



- Endstück aus Kunststoff für Aluschiene Serie V18025.
- Plastic end cap for bar series V18025.

10

ART. NR. / ITEM NO.

V23389



- Horizontale Aluschiene.
- Horizontal aluminium bar.

3

ART. NR. / ITEM NO.

- V18030 10** Länge - Length 1000 mm
- V18030 15** Länge - Length 1500 mm
- V18030 20** Länge - Length 2000 mm
- V18030 25** Länge - Length 2500 mm
- V18030 30** Länge - Length 3000 mm



- Zurrgurt mit Ratschenschloss 2500+500.
- Load restraining belt with ratchet 2500+500.

8

ART. NR. / ITEM NO.

V22124



- Zurrgurt mit Ratschenschloss 4500+500.
- Load restraining belt with ratchet 4500+500.

9

ART. NR. / ITEM NO.

V22148



- Beispiel von Ladungssicherungskoffer-kit.
- Example of tool case for load securing.



1 ART. NR. / ITEM NO.
BOX080

B=440 T=350 H=80 mm
W=440 D=350 H=80 mm



2 ART. NR. / ITEM NO.
V22136



1 ART. NR. / ITEM NO.
CPV080



2 ART. NR. / ITEM NO.
V22124



4 ART. NR. / ITEM NO.
V225820



2 ART. NR. / ITEM NO.
V22148



1 ART. NR. / ITEM NO.
YELLOW

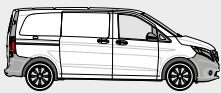

BESTANDTEILELISTE SEITENWANDVERKLEIDUNGEN - LININGS LEGEND

MERCEDES-BENZ VITO
KASTENWAGEN - PANEL VAN

HP
HONEYCOMB
PANEL

- Für Fahrzeug mit rechter Schiebetür und Seitenwänden aus Vollblech.
- For right side door vehicle with metal sheet sidewalls.

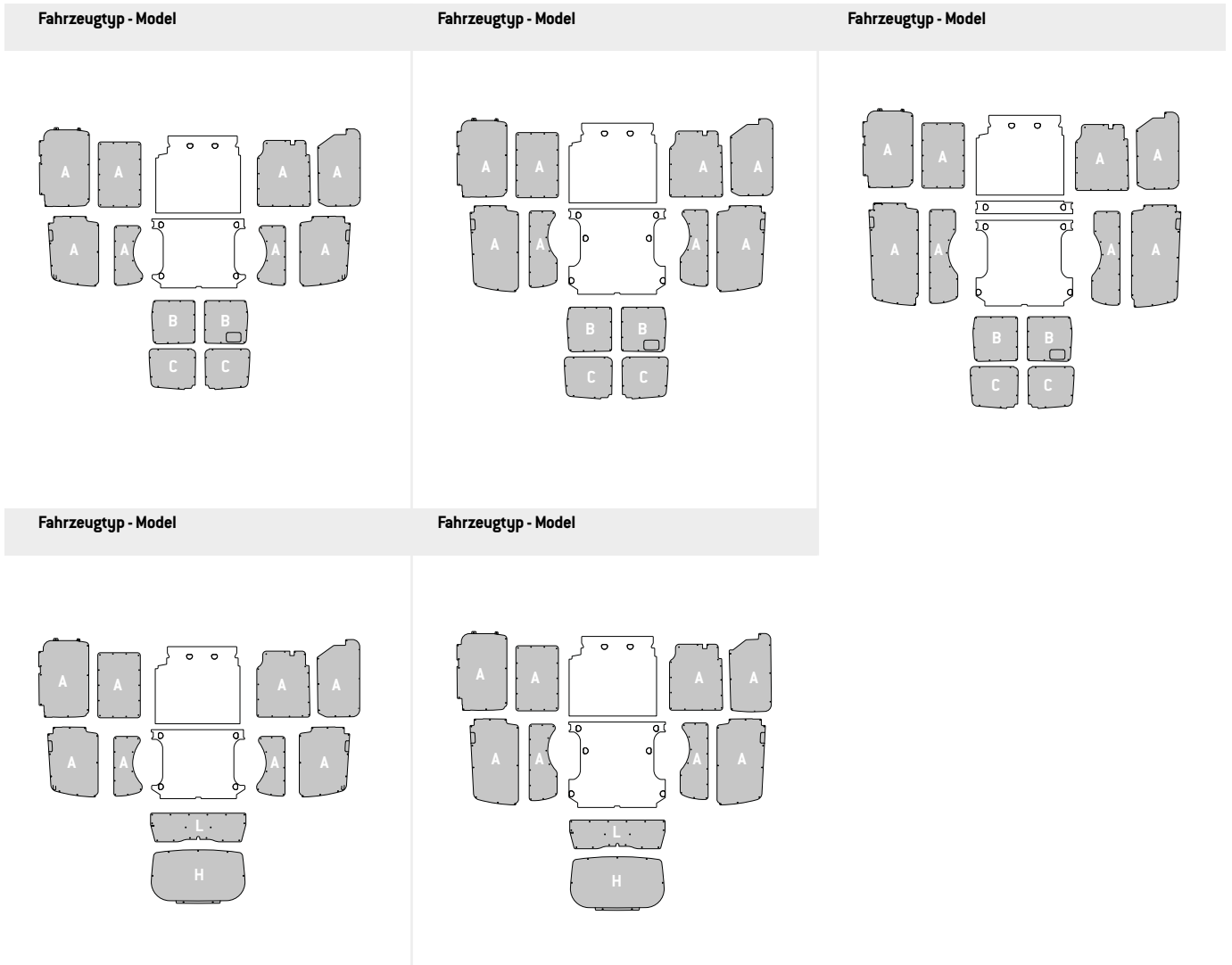

- ^A Heckflügeltüren - Rear hinged doors
- ^B Heckklappe - Rear gate

SAFETY CROSS: Fixierpunkte in Längs- und Querrichtung nach Anfrage.
SAFETY CROSS: longitudinal and transversal fixing points upon request.

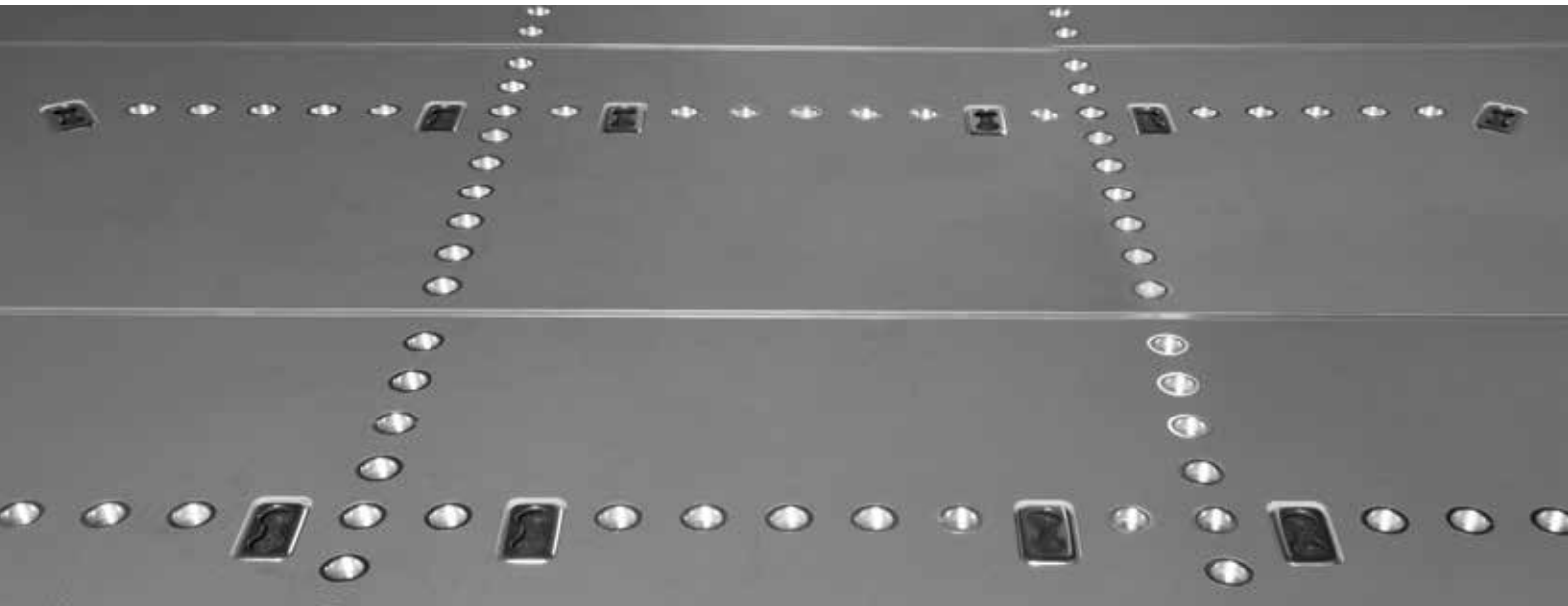

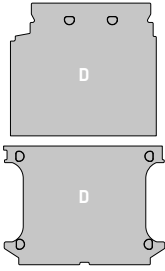
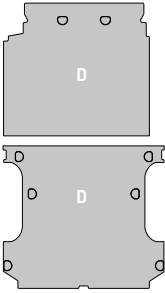
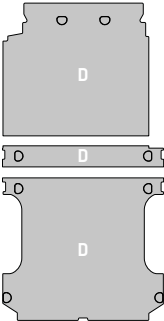

- Für Fahrzeug mit rechter Schiebetür und Seitenwänden aus Vollblech.
- For right side door vehicle with metal sheet sidewalls.

Fahrzeugtyp - Model	Fahrzeugtyp - Model	Fahrzeugtyp - Model
		

KASTENWAGEN - PANEL VAN
MERCEDES-BENZ VITO

WOOD
FLOOR
WF

- Für Fahrzeug mit rechter Schiebetür und Seitenwänden aus Vollblech.
- For right side door vehicle with metal sheet sidewalls.

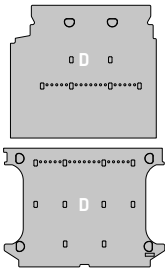
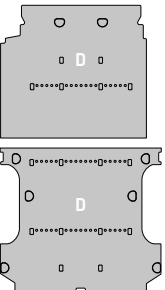
Fahrzeugtyp - Model	Fahrzeugtyp - Model
	



L1H1 / L2H1

- Jede Reihe von Verankerungspunkten für jede Bodenplatte besteht aus 6 "Airline" Einzelzurrpunkten und 19 Fixierspunkten für „Airline“ Sperrstangen.

- In each flooring, each lashing row is composed of 6 "Airline" lashing points and 19 fixing points for "Airline" shoring bars

SAFETY
FLOOR
SF

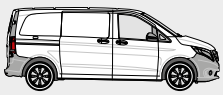

**Serienmäßig mit
Ladungssicherung**

Factory-fitted load
securing



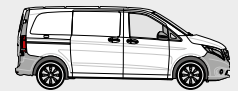

Die Lösungen der **SAFETY Transportereinrichtungen** von Store Van erfüllen die Erfordernisse der neuen Ladungssicherungsbestimmungen. In die Module werden Strukturelemente eingebaut, die eine Nutzung der „Airline“ Festhaltesysteme wie Gurte, Netze und teleskopische Spannstangen erlauben. Dieses neue Niveau der **Einrichtungen für Nutzfahrzeuge** erleichtert das Verankern von mittelgroßen und kleinen Gegenständen, selbst wenn die Transporter-Bodenplatten nicht mit Verankerungssystemen ausgestattet sind, und garantiert dadurch die Ladungssicherung. Die „Airline“ Verankerungselemente des SAFETY-Niveaus erhöhen die Stabilität der Module ohne Gewichtszunahme, denn sie in der Struktur der Einrichtung integriert sind.

The Store Van **SAFETY equipment solution** meets the requirements of the new cargo restraint regulations. Our modules are integrated with structural elements where “Airline” anchoring fittings, such as belts, nets and telescopic bars can easily fit. This new equipment for commercial vehicles simplifies the securing of medium-sized or small parts, even if the floor panel of your van has no anchoring systems, to guarantee maximum load securing. The “Airline” anchoring fittings for SAFETY equipment improve the stability of modules with no weight increase, because they are built in the equipment structure.



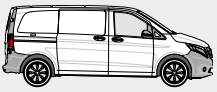

Kompakt - Compact

MERCEDES-BENZ VITO
KASTENWAGEN - PANEL VAN

SAFETY

FAHRZEUGEINRICHTUNGSBEISPIELE - FITTINGS EXAMPLES

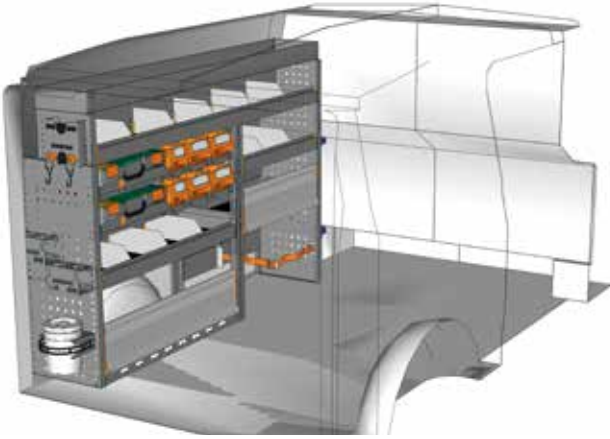

BEISPIEL - EXAMPLE

VT 1712 01*

B=1733 T=365 H=1190 mm - W=1733 D=365 H=1190 mm

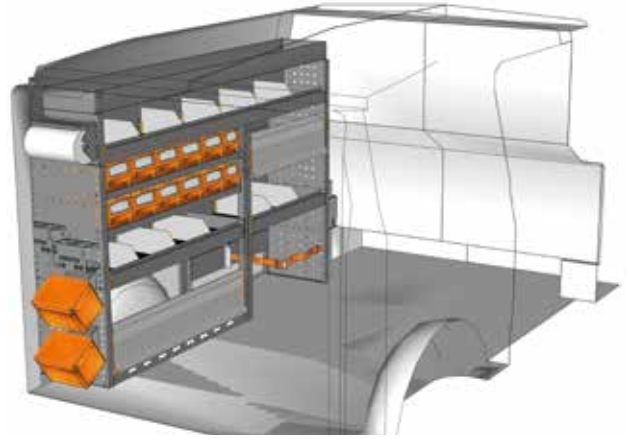

BEISPIEL - EXAMPLE

VT 1712 05*

B=1733 T=365 H=1190 mm - W=1733 D=365 H=1190 mm

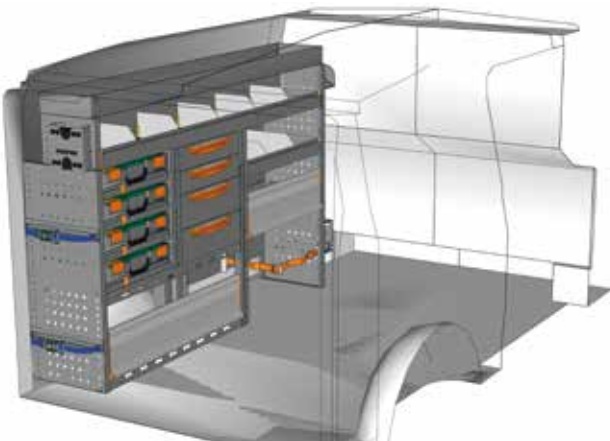

BEISPIEL - EXAMPLE

VT 1712 06*

B=1733 T=365 H=1190 mm - W=1733 D=365 H=1190 mm

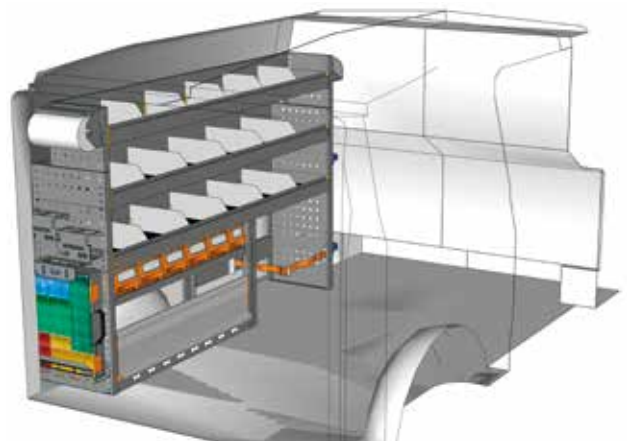
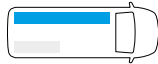

BEISPIEL - EXAMPLE

VT 1712 07*

B=1733 T=365 H=1150 mm - W=1733 D=365 H=1150 mm

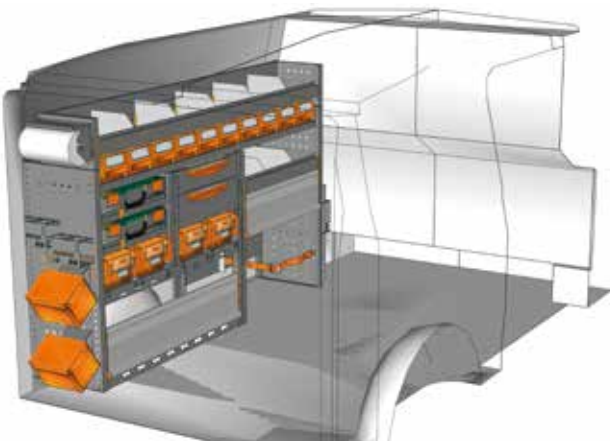
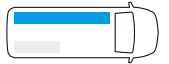

BEISPIEL - EXAMPLE

VT 1712 10*

B=1733 T=365 H=1100 mm - W=1733 D=365 H=1100 mm

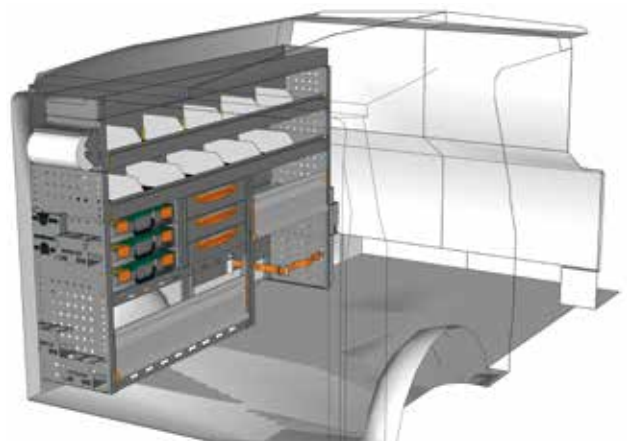
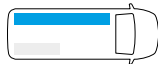

BEISPIEL - EXAMPLE

VT 1712 11*

B=1733 T=365 H=1190 mm - W=1733 D=365 H=1190 mm

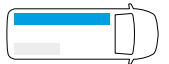

* Einschließlich Befestigungskit - Fixing kit included

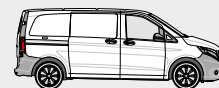

FAHRZEUGEINRICHTUNGSBEISPIELE - FITTINGS EXAMPLES

KASTENWAGEN - PANEL VAN
MERCEDES-BENZ VITO
SAFETY

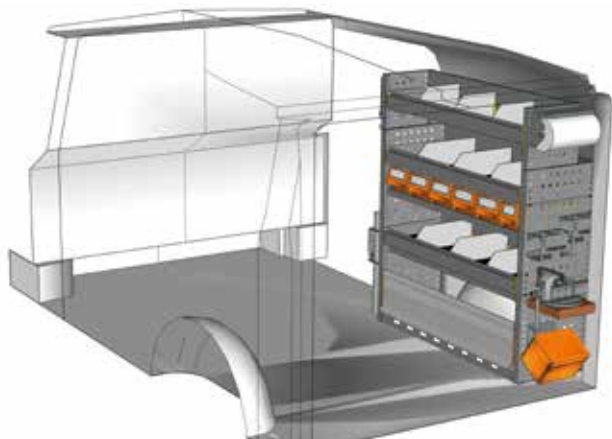

BEISPIEL - EXAMPLE

VT 1012 21*

B=1016 T=365 H=1150 mm - W=1016 D=365 H=1150 mm

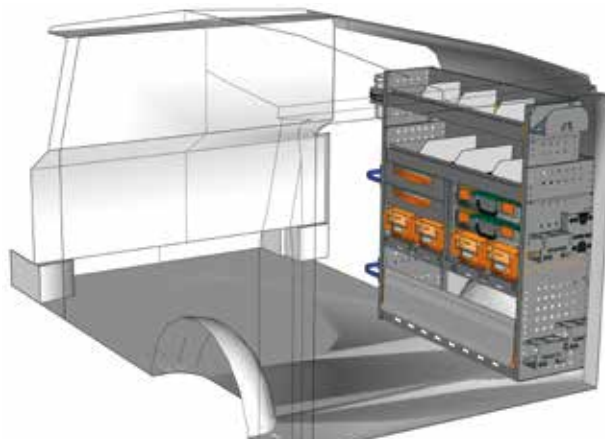
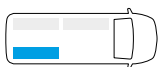

BEISPIEL - EXAMPLE

VT 1012 22*

B=1016 T=365 H=1150 mm - W=1016 D=365 H=1150 mm

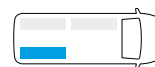

Ansicht von der Schiebetür
View from side door

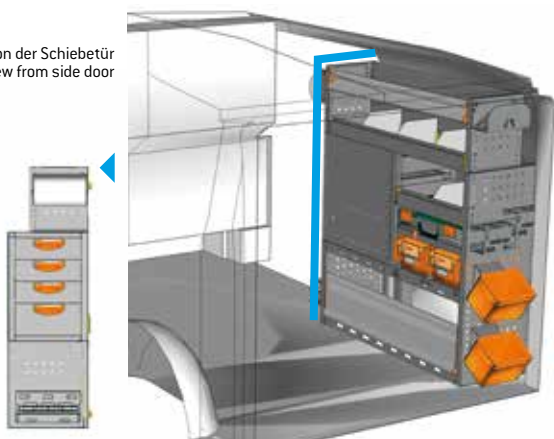

BEISPIEL - EXAMPLE

VT 1012 25*

B=1016 T=365 H=1200 mm - W=1016 D=365 H=1200 mm

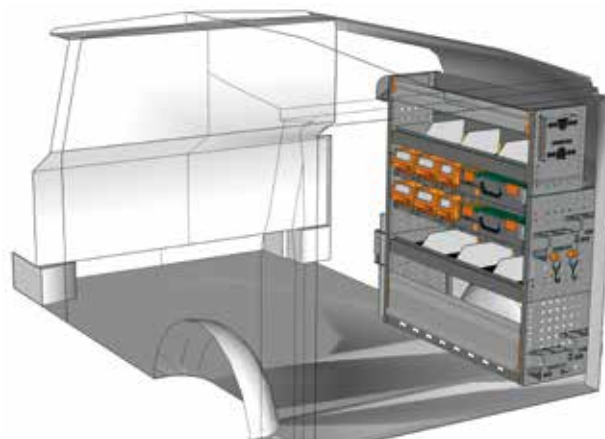
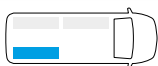

BEISPIEL - EXAMPLE

VT 1012 31*

B=1016 T=365 H=1150 mm - W=1016 D=365 H=1150 mm

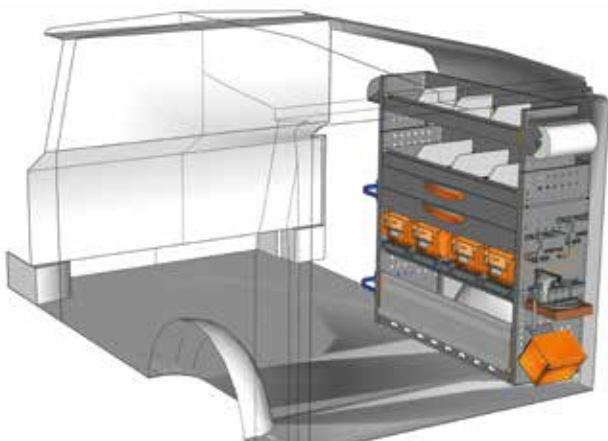
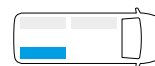

BEISPIEL - EXAMPLE

VT 1012 34*

B=1016 T=365 H=1150 mm - W=1016 D=365 H=1150 mm

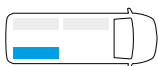

Haben Sie Ihre Einrichtung nicht gefunden?
Verlassen Sie sich auf die Profis für Fahrzeugeinrichtungen.
Auf der Rückseite dieses Katalogs finden Sie die nächstgelegene StoreVan Niederlassung. Besuchen Sie unsere Web-Seite.

Didn't find the equipment you're looking for? Leave it to our experts.
See the back of this catalogue and contact the nearest StoreVan point or visit our website.



* Einschließlich Befestigungskit - Fixing kit included

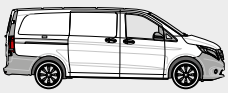

Lang - Long

MERCEDES-BENZ VITO
KASTENWAGEN - PANEL VAN

SAFETY

FAHRZEUGEINRICHTUNGSBEISPIELE - FITTINGS EXAMPLES

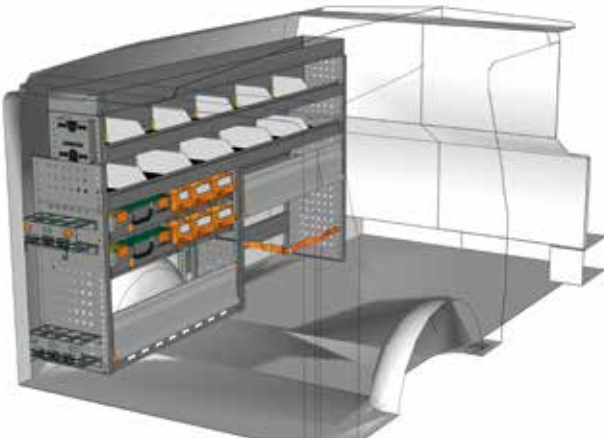

BEISPIEL - EXAMPLE

VT 2012 01*

B=2032 T=365 H=1190 mm - W=2032 D=365 H=1190 mm

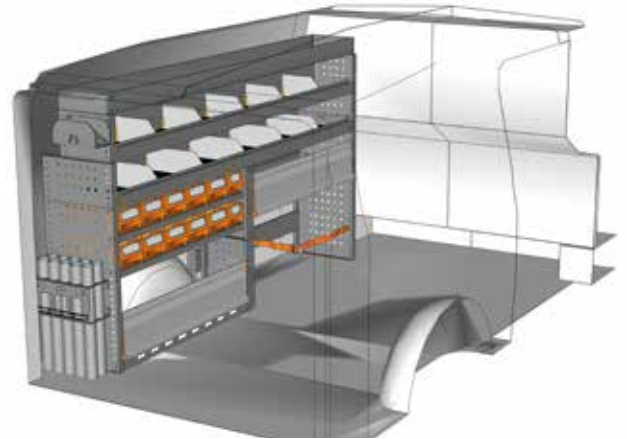
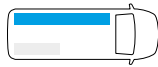

BEISPIEL - EXAMPLE

VT 2012 05*

B=2032 T=365 H=1190 mm - W=2032 D=365 H=1190 mm

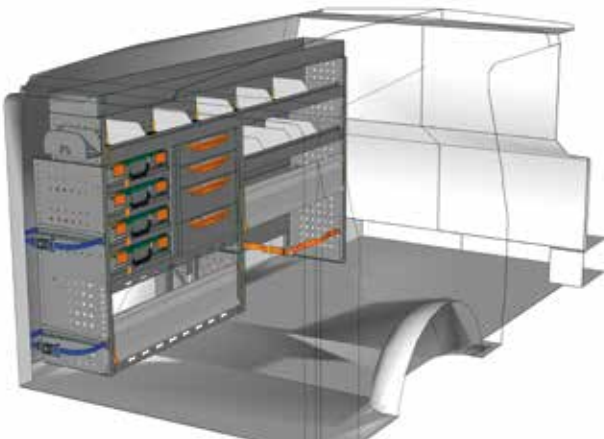
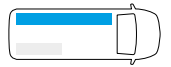

BEISPIEL - EXAMPLE

VT 2012 06*

B=2032 T=365 H=1190 mm - W=2032 D=365 H=1190 mm

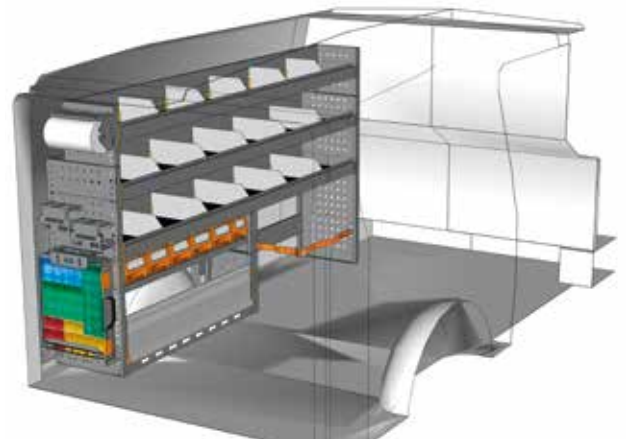
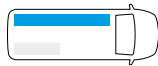

BEISPIEL - EXAMPLE

VT 2012 07*

B=2032 T=365 H=1150 mm - W=2032 D=365 H=1150 mm

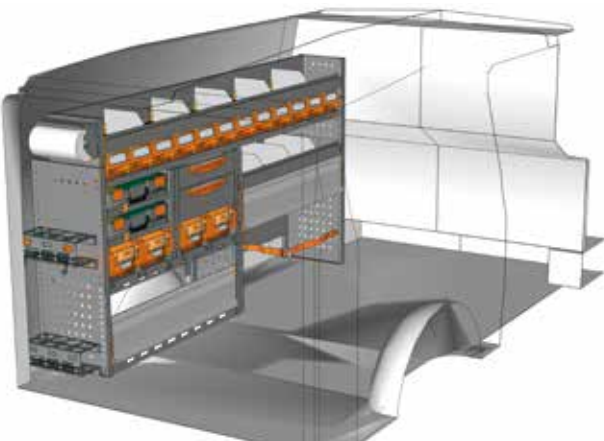

BEISPIEL - EXAMPLE

VT 2012 10*

B=2032 T=365 H=1100 mm - W=2032 D=365 H=1100 mm

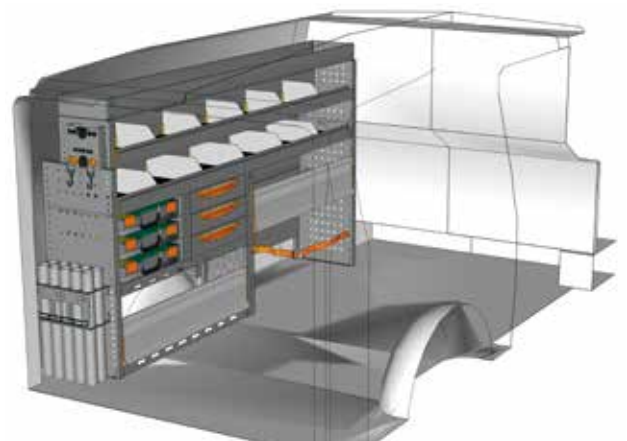
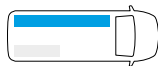

BEISPIEL - EXAMPLE

VT 2012 11*

B=2032 T=365 H=1190 mm - W=2032 D=365 H=1190 mm

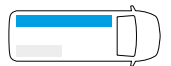

* Einschließlich Befestigungskit - Fixing kit included

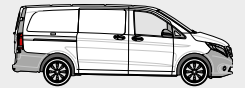

FAHRZEUGEINRICHTUNGSBEISPIELE - FITTINGS EXAMPLES

KASTENWAGEN - PANEL VAN
MERCEDES-BENZ VITO

SAFETY

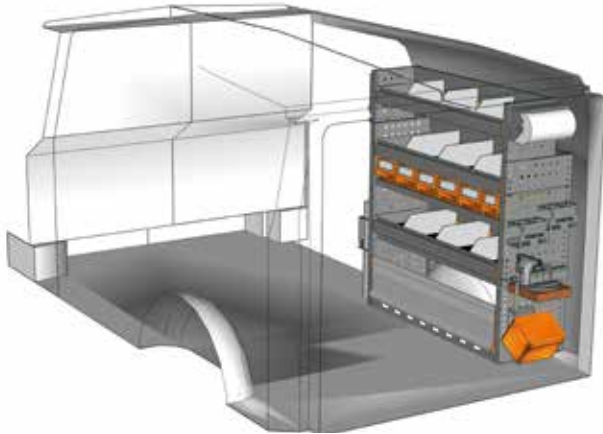

BEISPIEL - EXAMPLE

VT 1012 01*

B=1016 T=365 H=1150 mm - W=1016 D=365 H=1150 mm

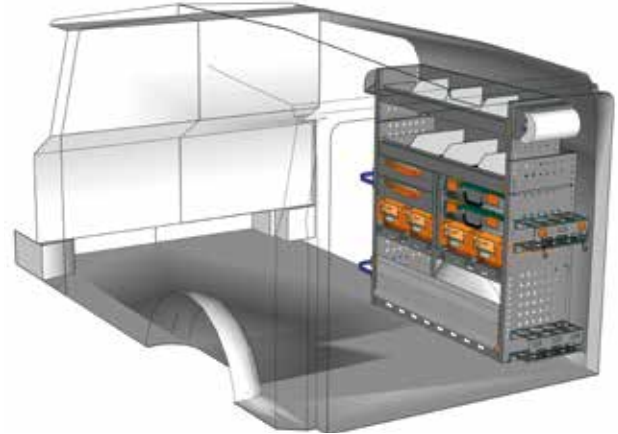
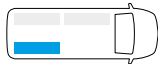

BEISPIEL - EXAMPLE

VT 1012 02*

B=1016 T=365 H=1150 mm - W=1016 D=365 H=1150 mm

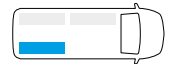

Ansicht von der Schiebetür
View from side door

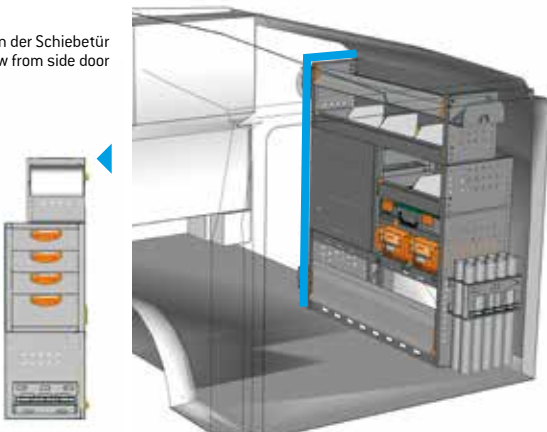

BEISPIEL - EXAMPLE

VT 1012 05*

B=1016 T=365 H=2000 mm - W=1016 D=365 H=2000 mm

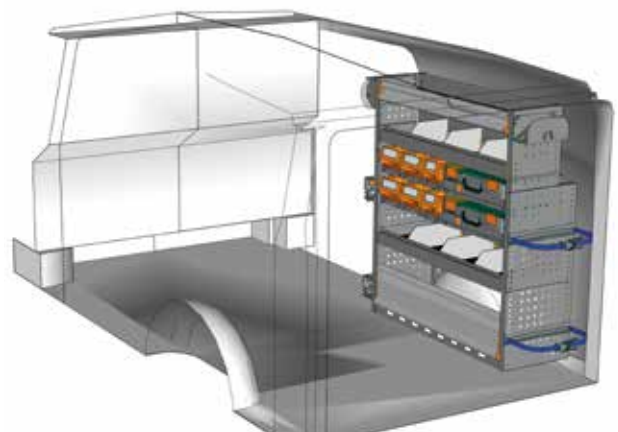
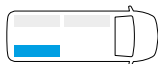

BEISPIEL - EXAMPLE

VT 1012 11*

B=1016 T=365 H=1150 mm - W=1016 D=365 H=1150 mm

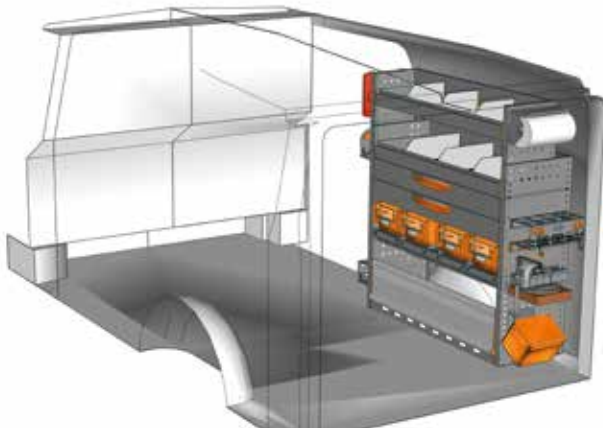
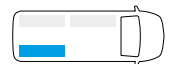

BEISPIEL - EXAMPLE

VT 1012 14*

B=1016 T=365 H=1150 mm - W=1016 D=365 H=1150 mm

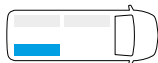

Haben Sie Ihre Einrichtung nicht gefunden?
Verlassen Sie sich auf die Profis für Fahrzeugeinrichtungen.

Auf der Rückseite dieses Katalogs finden Sie die nächstgelegene StoreVan Niederlassung. Besuchen Sie unsere Web-Seite.

Didn't find the equipment you're looking for? Leave it to our experts.

See the back of this catalogue and contact the nearest StoreVan point or visit our website.



* Einschließlich Befestigungskit - Fixing kit included

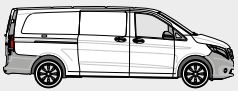

Extralang - Extra Long

MERCEDES-BENZ VITO
KASTENWAGEN - PANEL VAN

SAFETY

FAHRZEUGEINRICHTUNGSBEISPIELE - FITTINGS EXAMPLES

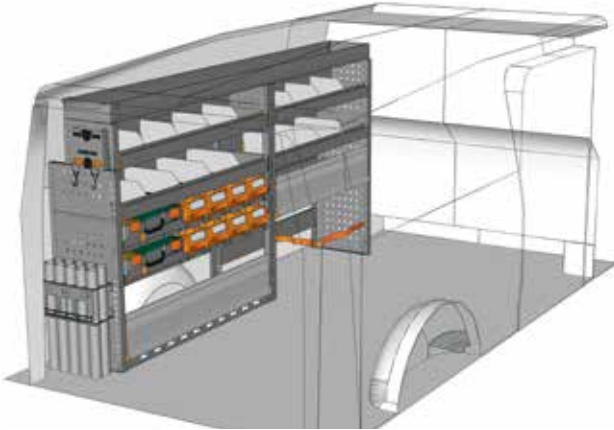

BEISPIEL - EXAMPLE

VT 2212 01*

B=2241 T=365 H=1190 mm - W=2241 D=365 H=1190 mm

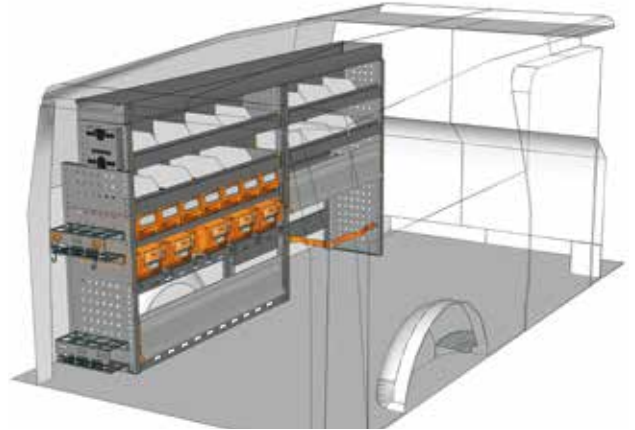
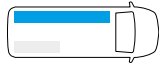

BEISPIEL - EXAMPLE

VT 2212 02*

B=2241 T=365 H=1190 mm - W=2241 D=365 H=1190 mm

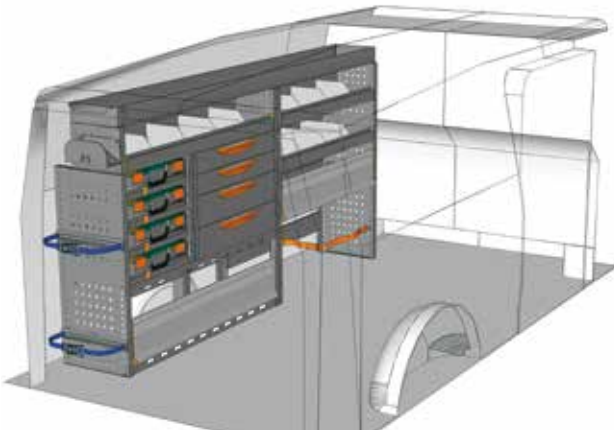

BEISPIEL - EXAMPLE

VT 2212 03*

B=2241 T=365 H=1190 mm - W=2241 D=365 H=1190 mm

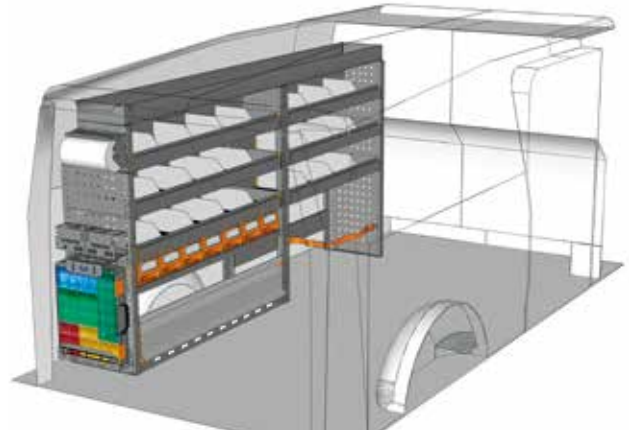
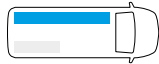

BEISPIEL - EXAMPLE

VT 2212 04*

B=2241 T=365 H=1190 mm - W=2241 D=365 H=1190 mm

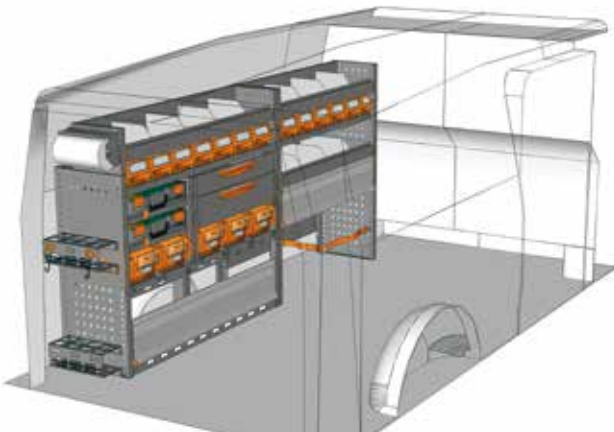

BEISPIEL - EXAMPLE

VT 2212 05*

B=2241 T=365 H=1190 mm - W=2241 D=365 H=1190 mm

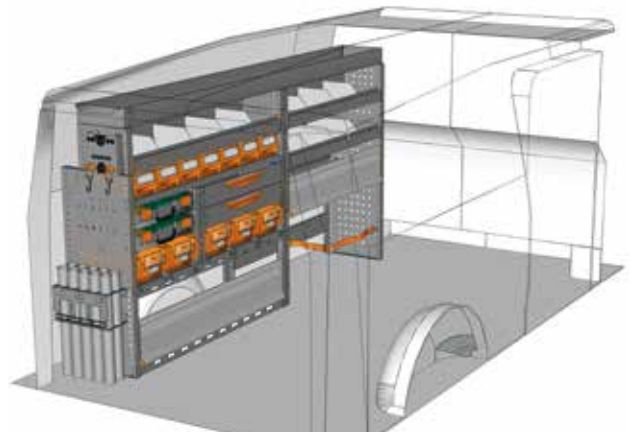
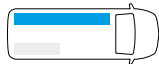

BEISPIEL - EXAMPLE

VT 2212 06*

B=2241 T=365 H=1190 mm - W=2241 D=365 H=1190 mm

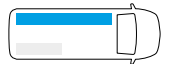

* Einschließlich Befestigungskit - Fixing kit included

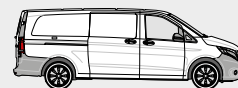

FAHRZEUGEINRICHTUNGSBEISPIELE - FITTINGS EXAMPLES

KASTENWAGEN - PANEL VAN
MERCEDES-BENZ VITO

SAFETY

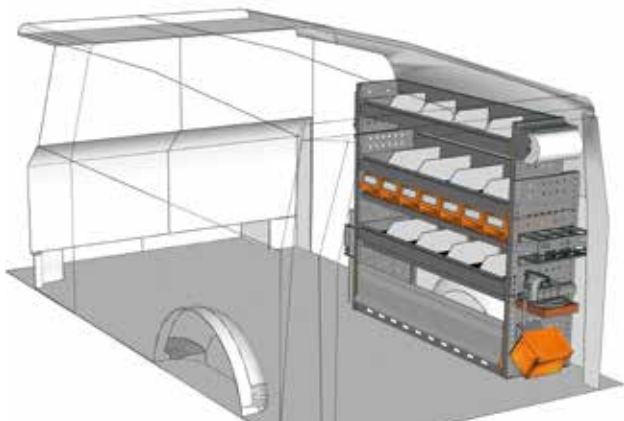

BEISPIEL - EXAMPLE

VT 1212 01*

B=1225 T=365 H=1150 mm - W=1225 D=365 H=1150 mm

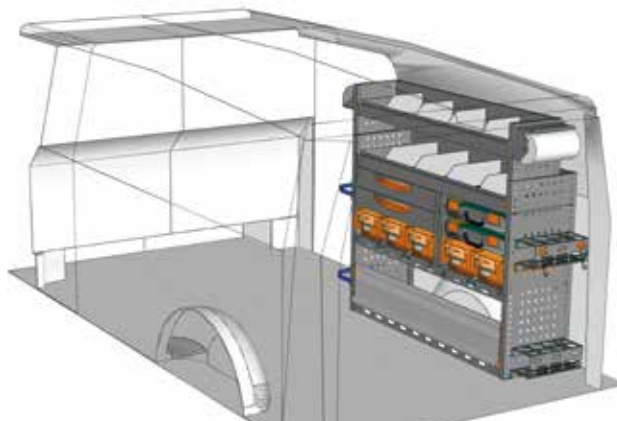
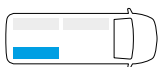

BEISPIEL - EXAMPLE

VT 1212 02*

B=1225 T=365 H=1150 mm - W=1225 D=365 H=1150 mm

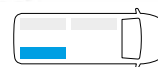

Ansicht von der Schiebetür
View from side door

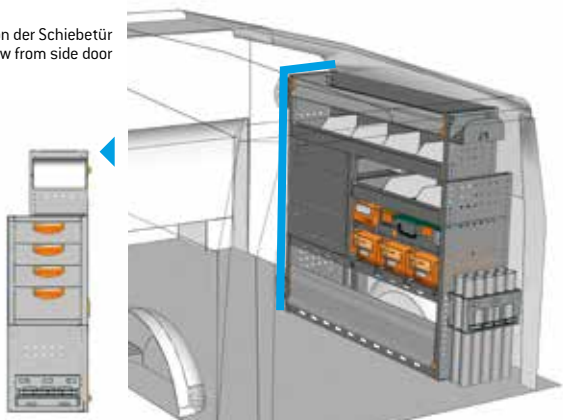

BEISPIEL - EXAMPLE

VT 1212 03*

B=1225 T=365 H=1200 mm - W=1225 D=365 H=1200 mm

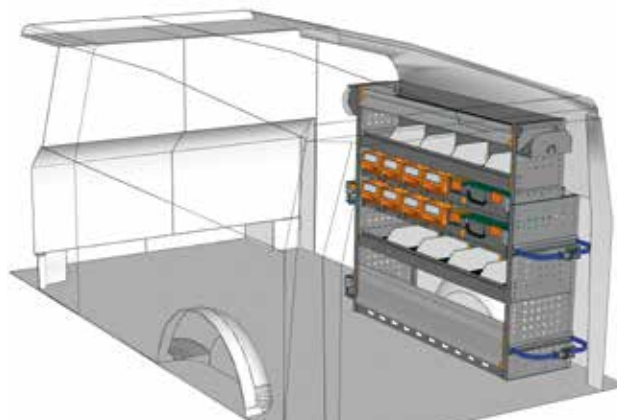
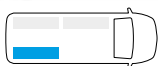

BEISPIEL - EXAMPLE

VT 1212 04*

B=1225 T=365 H=1150 mm - W=1225 D=365 H=1150 mm

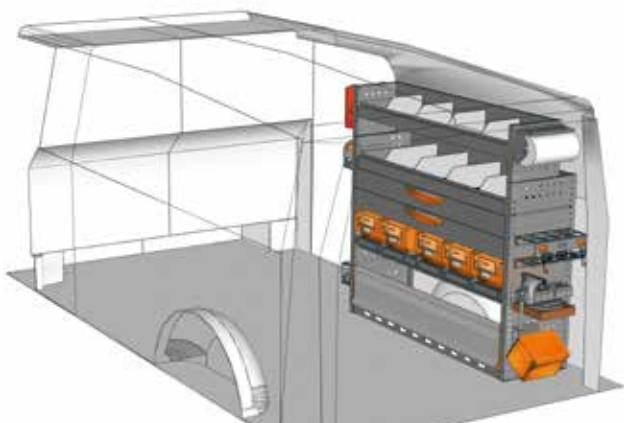
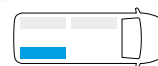

BEISPIEL - EXAMPLE

VT 1212 05*

B=1225 T=365 H=1150 mm - W=1225 D=365 H=1150 mm

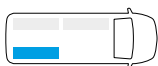

Haben Sie Ihre Einrichtung nicht gefunden?
Verlassen Sie sich auf die Profis für Fahrzeugeinrichtungen.

Auf der Rückseite dieses Katalogs finden Sie die nächstgelegene StoreVan Niederlassung. Besuchen Sie unsere Web-Seite.

Didn't find the equipment you're looking for? Leave it to our experts.

See the back of this catalogue and contact the nearest StoreVan point or visit our website.



* Einschließlich Befestigungskit - Fixing kit included

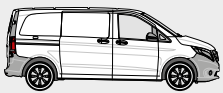

Die perfekte Integration zwischen Fahrzeug und mobiler Werkstatteinrichtung

Perfect integration
between vehicle and mobile
workshop equipment



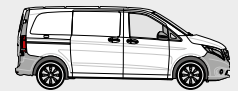

Die **Transportereinrichtung PROFESSIONAL** von Store Van ist perfekt im Fahrzeug integriert und eigens so entwickelt, dass sie die strukturellen und dynamischen Eigenschaften des Fahrzeugs hervorhebt. In den Modulen dieses neuen **Einrichtungsniveaus für Nutzfahrzeug**, z.B. in den Regalen für Transporter, sind für eine perfekte Befestigung der Ladung am Fahrzeugrahmen serienmäßig Elemente eingebaut, die „Airline“ Festhaltesysteme nutzen. Dank der neuen Bodenplatte SAFETY FLOOR stehen für die Ladungen vertikale und horizontale Festhaltesysteme zur Verfügung.

The Store Van **PROFESSIONAL equipment solution** is perfectly integrated in your vehicle and has been designed to enhance its structural and dynamic characteristics. The modules of this new **equipment for commercial vehicles**, such as shelving units for vans, are factory fitted with elements ensuring a perfect load anchoring to the chassis of your vehicle with “Airline” anchoring systems.

Both vertical and horizontal load restraining elements can be installed in your van thanks to the new SAFETY FLOOR panel.



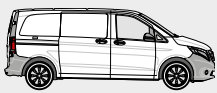

Kompakt - Compact

MERCEDES-BENZ VITO
KASTENWAGEN - PANEL VAN

PROFESSIONAL

FAHRZEUGEINRICHTUNGSBEISPIELE - FITTINGS EXAMPLES

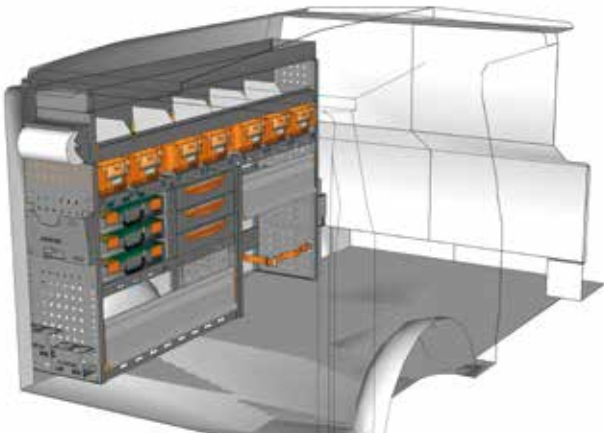

BEISPIEL - EXAMPLE

VT 1712 P1*

B=1733 T=365 H=1190 mm - W=1733 D=365 H=1190 mm

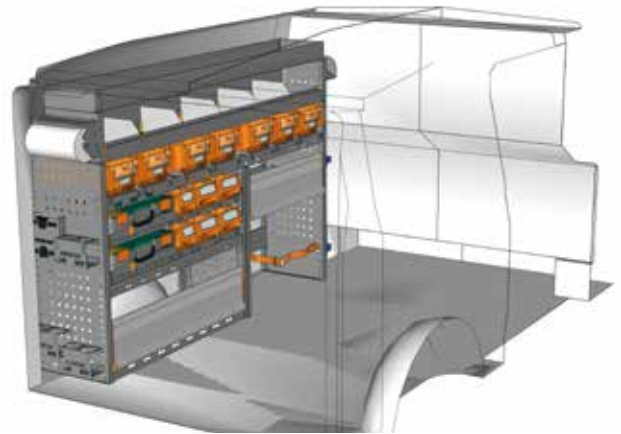
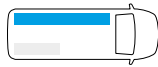

BEISPIEL - EXAMPLE

VT 1712 P2*

B=1733 T=365 H=1190 mm - W=1733 D=365 H=1190 mm

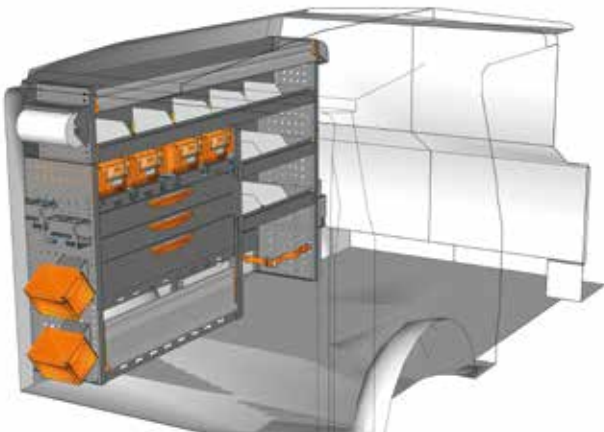
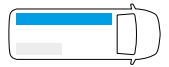

BEISPIEL - EXAMPLE

VT 1712 P3*

B=1733 T=365 H=1200 mm - W=1733 D=365 H=1200 mm

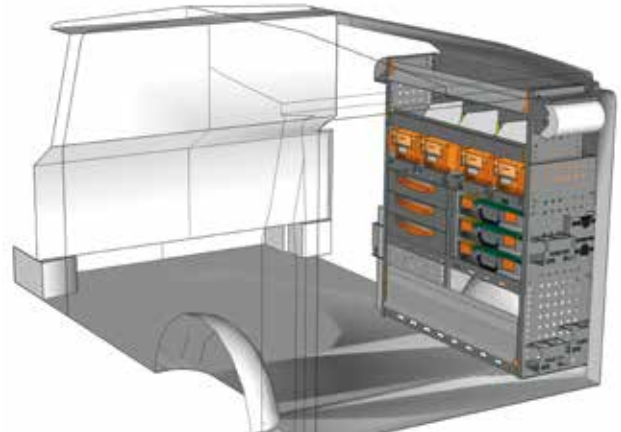
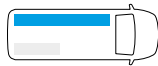

BEISPIEL - EXAMPLE

VT 1012 P1*

B=1016 T=365 H=1200 mm - W=1016 D=365 H=1200 mm

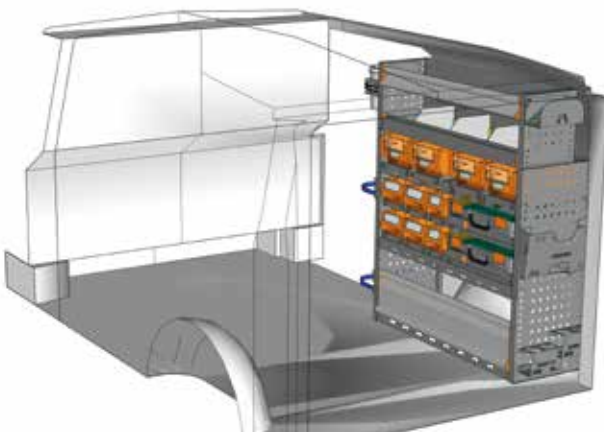
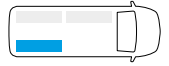

BEISPIEL - EXAMPLE

VT 1012 P2*

B=1016 T=365 H=1200 mm - W=1016 D=365 H=1200 mm

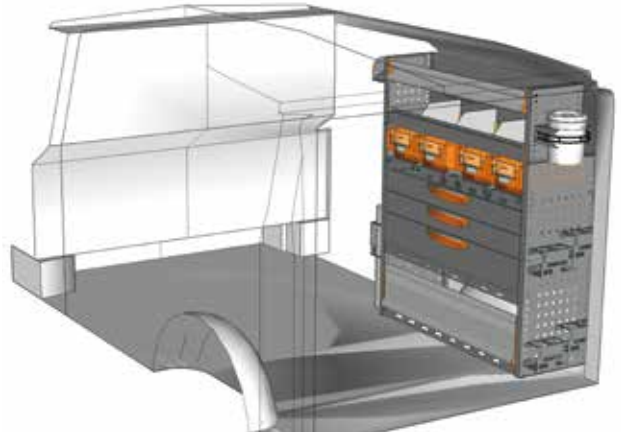
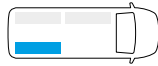

BEISPIEL - EXAMPLE

VT 1012 P3*

B=1016 T=365 H=1200 mm - W=1016 D=365 H=1200 mm

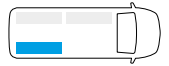

* Einschließlich Befestigungskit - Fixing kit included

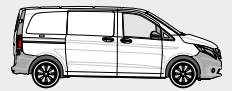

FAHRZEUGEINRICHTUNGSBEISPIELE - FITTINGS EXAMPLES

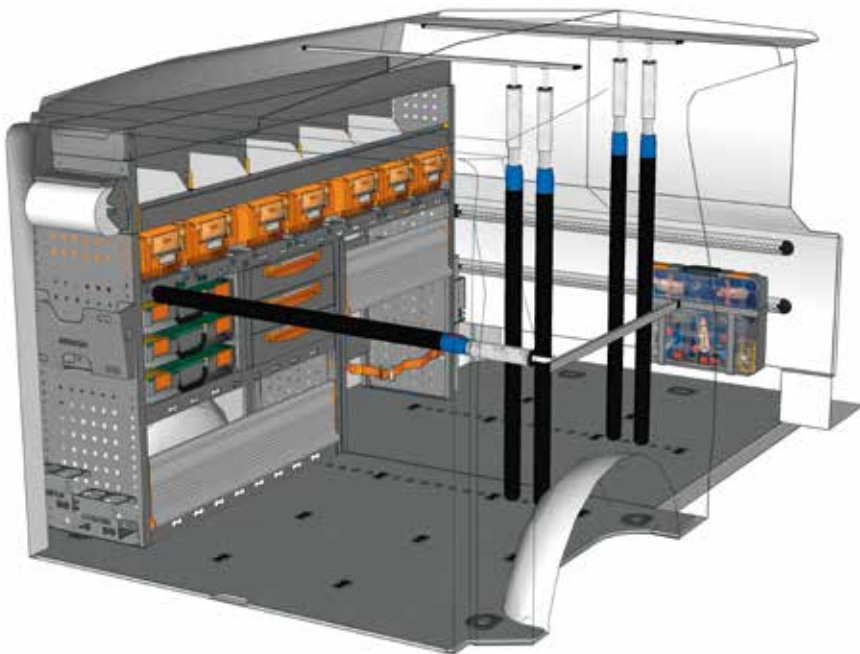

BEISPIEL - EXAMPLE

EXAMPLE VT L1H1 P1*



1 x VT 1712 P1	6 x V23389
1 x VT 10G1 A0	1 x BOX080
1 x V22585	1 x CPV080
4 x V22131	2 x V22136
1 x V22735	2 x V22124
2 x V18029 15	2 x V22148
4 x V22106	1 x YELLOW
3 x V18025 10	4 x V225820

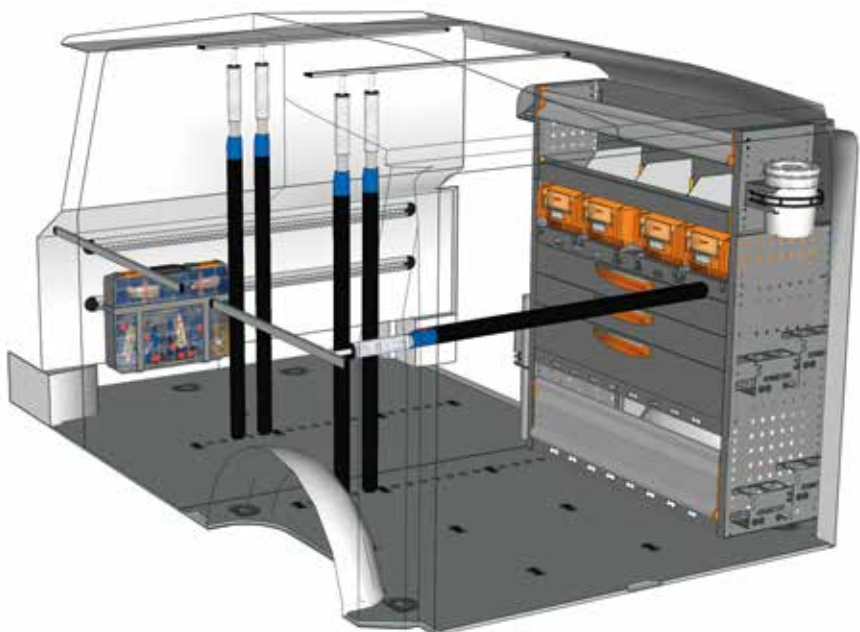

BEISPIEL - EXAMPLE

EXAMPLE VT L1H1 P2*



1 x VT 1012 P3	8 x V23389
1 x VT 10G1 A0	1 x BOX080
1 x V22585	1 x CPV080
4 x V22131	2 x V22136
1 x V22735	2 x V22124
2 x V18029 15	2 x V22148
4 x V22106	1 x YELLOW
4 x V18025 10	4 x V225820

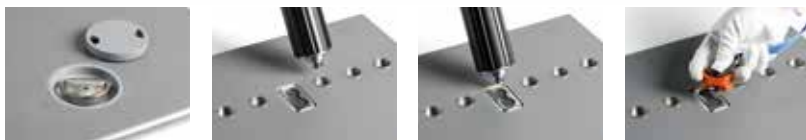

siehe Seiten 10/11
see pages 10/11

* Einschließlich Befestigungskit - Fixing kit included

**Haben Sie Ihre Einrichtung nicht gefunden?
Verlassen Sie sich auf die Profis für
Fahrzeugeinrichtungen.**

Auf der Rückseite dieses Katalogs
finden Sie die nächstgelegene
StoreVan Niederlassung.
Besuchen Sie unsere Web-Seite.

**Didn't find the equipment
you're looking for?
Leave it to our experts.**

See the back of this catalogue
and contact the nearest
StoreVan point or visit our website.



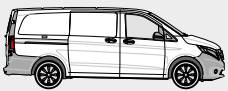

Lang - Long

MERCEDES-BENZ VITO
KASTENWAGEN - PANEL VAN

PROFESSIONAL

FAHRZEUGEINRICHTUNGSBEISPIELE - FITTINGS EXAMPLES

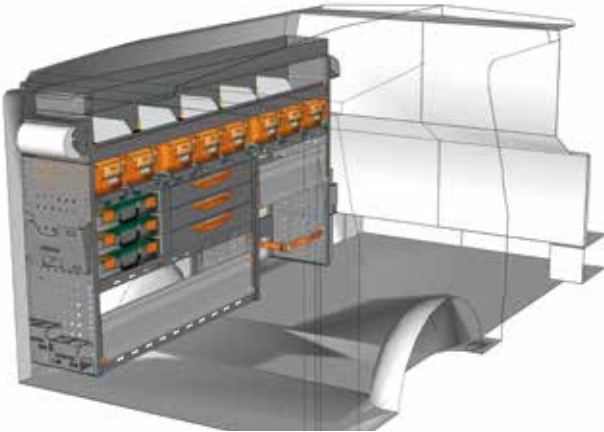

BEISPIEL - EXAMPLE

VT 1912 P1*

B=1942 T=365 H=1190 mm - W=1942 D=365 H=1190 mm

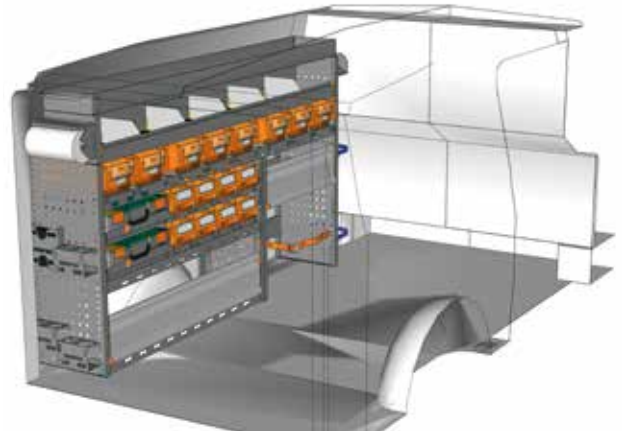
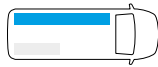

BEISPIEL - EXAMPLE

VT 1912 P2*

B=1942 T=365 H=1190 mm - W=1942 D=365 H=1190 mm

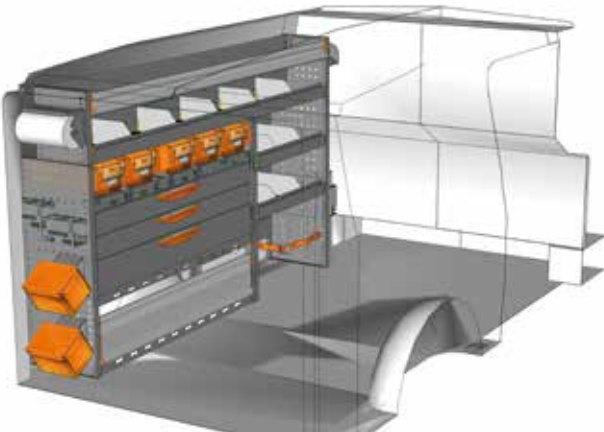
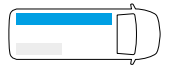

BEISPIEL - EXAMPLE

VT 1912 P3*

B=1942 T=365 H=1200 mm - W=1942 D=365 H=1200 mm

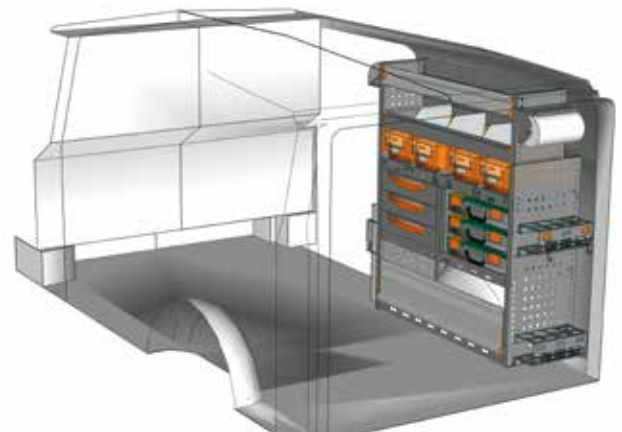
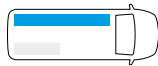

BEISPIEL - EXAMPLE

VT 1012 P4*

B=1016 T=365 H=1200 mm - W=1016 D=365 H=1200 mm

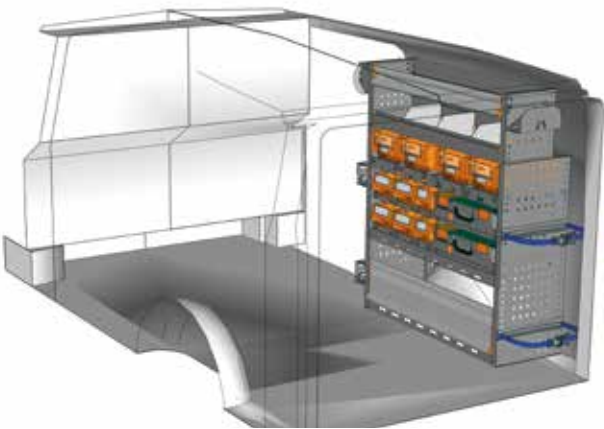
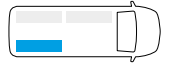

BEISPIEL - EXAMPLE

VT 1012 P5*

B=1016 T=365 H=1200 mm - W=1016 D=365 H=1200 mm

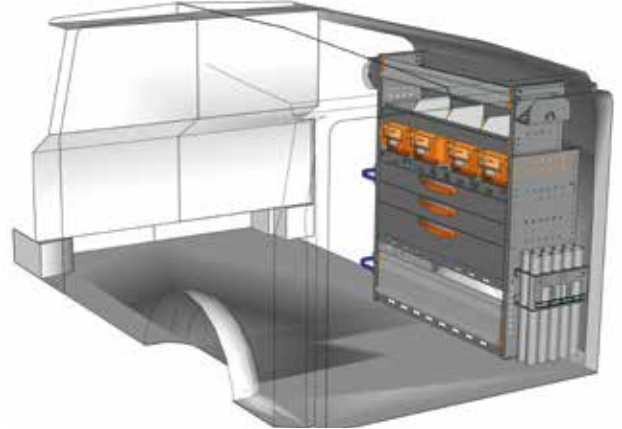
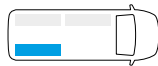

BEISPIEL - EXAMPLE

VT 1012 P6*

B=1016 T=365 H=1200 mm - W=1016 D=365 H=1200 mm

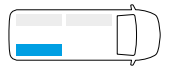

* Einschließlich Befestigungskit - Fixing kit included

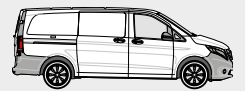

FAHRZEUGEINRICHTUNGSBEISPIELE - FITTINGS EXAMPLES

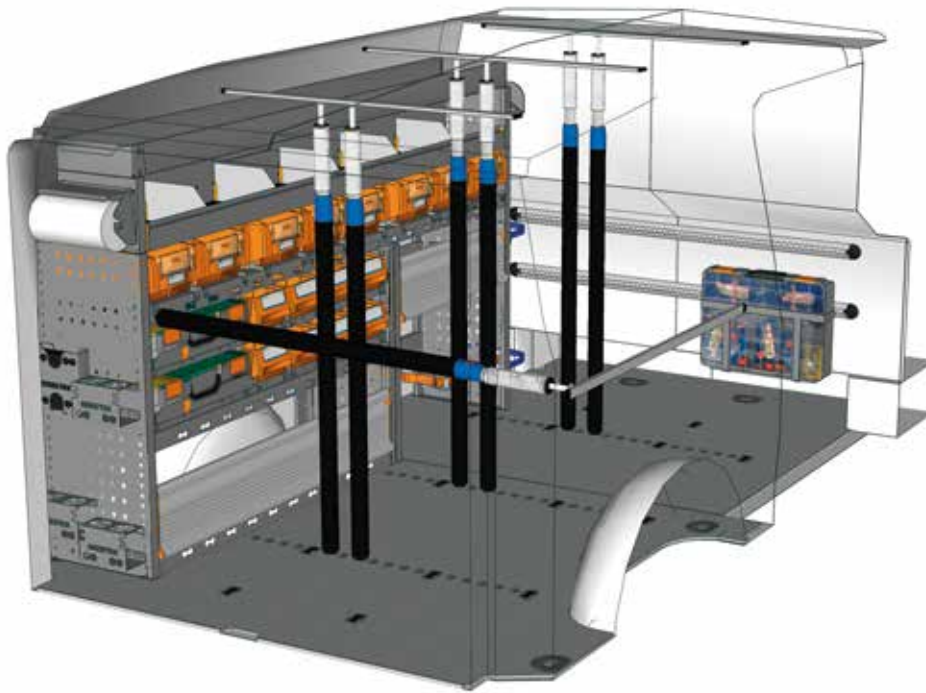

BEISPIEL - EXAMPLE

EXAMPLE VT L1LH1 P1*



- | | |
|----------------|-------------|
| 1 x VT 1912 P2 | 8 x V23389 |
| 1 x VT 1LG1 A0 | 1 x B0X080 |
| 1 x V22585 | 1 x CPV080 |
| 4 x V22131 | 2 x V22136 |
| 3 x V22735 | 2 x V22124 |
| 2 x V18029 15 | 2 x V22148 |
| 4 x V22106 | 1 x YELLOW |
| 4 x V18025 10 | 4 x V225820 |

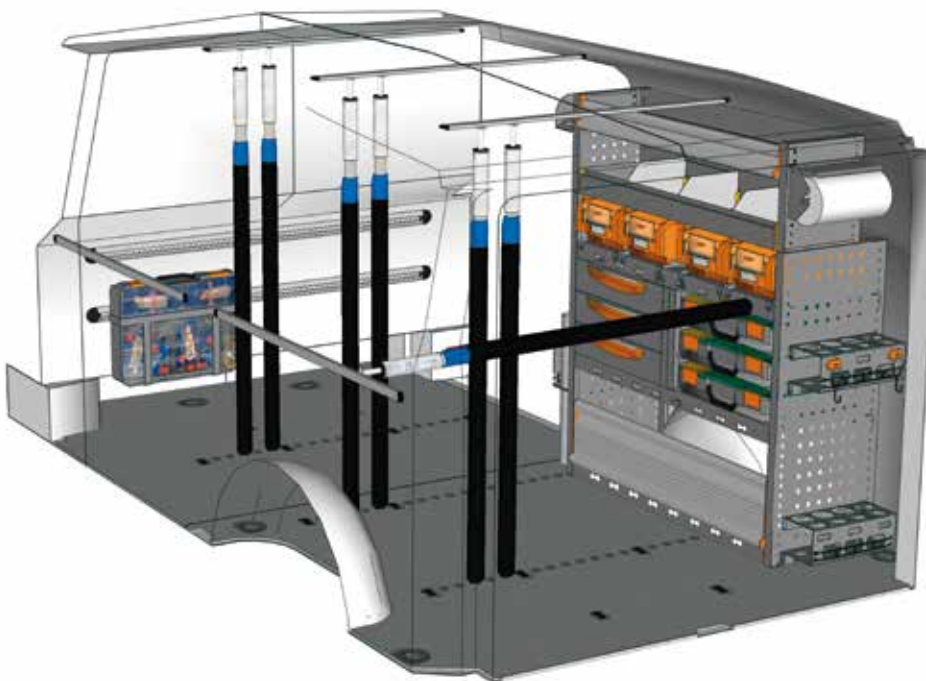

BEISPIEL - EXAMPLE

EXAMPLE VT L1LH1 P2*



- | | |
|----------------|-------------|
| 1 x VT 1012 P4 | 10 x V23389 |
| 1 x VT 1LG1 A0 | 1 x B0X080 |
| 1 x V22585 | 1 x CPV080 |
| 4 x V22131 | 2 x V22136 |
| 3 x V22735 | 2 x V22124 |
| 2 x V18029 15 | 2 x V22148 |
| 4 x V22106 | 1 x YELLOW |
| 5 x V18025 10 | 4 x V225820 |

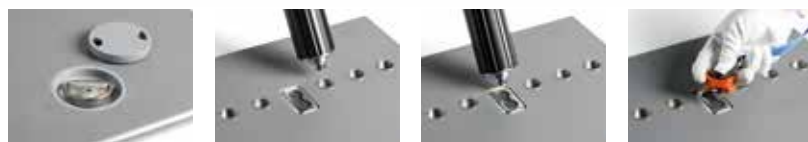

siehe Seiten 10/11
see pages 10/11

* Einschließlich Befestigungskit - Fixing kit included

**Haben Sie Ihre Einrichtung nicht gefunden?
Verlassen Sie sich auf die Profis für
Fahrzeugeinrichtungen.**

Auf der Rückseite dieses Katalogs
finden Sie die nächstgelegene
StoreVan Niederlassung.
Besuchen Sie unsere Web-Seite.

**Didn't find the equipment
you're looking for?
Leave it to our experts.**

See the back of this catalogue
and contact the nearest
StoreVan point or visit our website.



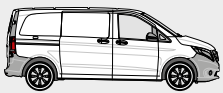

**Nicht nur
Fahrzeug,
sondern auch
Mobilität**

All-out
mobility



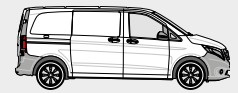

Die Lösung MOBILE ergänzt die Store Van Nutzfahrzeugeinrichtungen mit den Kleinteilekoffern der Serie STORE BOX 102 – 136 – 238 und den dazugehörigen Wagen, der den Benutzer der **mobilen Werkstatt** beim Transport der Waren und Ausrüstung vom Fahrzeug zur Arbeitsstelle unterstützt. Die neuen „Airline“ Verankerungselemente erhöhen die Stabilität des Moduls, ohne sein Gewicht zu beeinflussen. Auch in diesem Fall werden in den Regalen Elemente eingebaut, die eine Nutzung der „Airline“ Festhaltesysteme ermöglichen. Auch dank der Einführung der Bodenplatte SAFETY FLOOR können sowohl vertikale als auch horizontale Ladungssicherungssysteme gewählt werden.

The **MOBILE equipment solution** integrates Store Van fittings for commercial vehicles with small-parts cases, series STORE BOX 102 – 136 – 238, and trolleys by which **mobile workshop** users can easily carry their goods and tools from their van to the workplace.

The new “Airline” anchoring fittings improve the stability of modules with no weight increase. Here shelving units are integrated with elements where “Airline” anchoring systems can easily fit. Both vertical and horizontal load restraining elements can be installed in your van thanks to the new SAFETY FLOOR flooring panels.



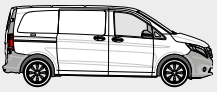

Kompakt - Compact

MERCEDES-BENZ VITO
KASTENWAGEN - PANEL VAN

MOBILE

FAHRZEUGEINRICHTUNGSBEISPIELE - FITTINGS EXAMPLES

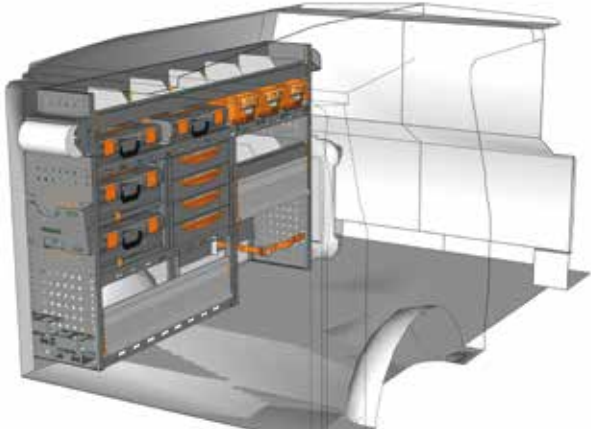

BEISPIEL - EXAMPLE

VT 1712 M1*

B=1733 T=365 H=1150 mm - W=1733 D=365 H=1150 mm

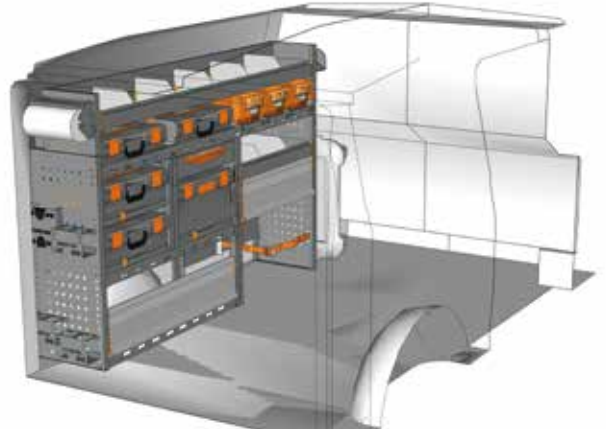
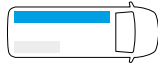

BEISPIEL - EXAMPLE

VT 1712 M2*

B=1733 T=365 H=1150 mm - W=1733 D=365 H=1150 mm

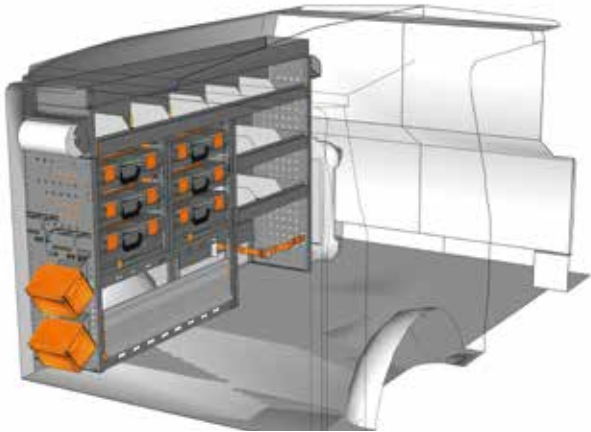

BEISPIEL - EXAMPLE

VT 1712 M3*

B=1733 T=365 H=1190 mm - W=1733 D=365 H=1190 mm

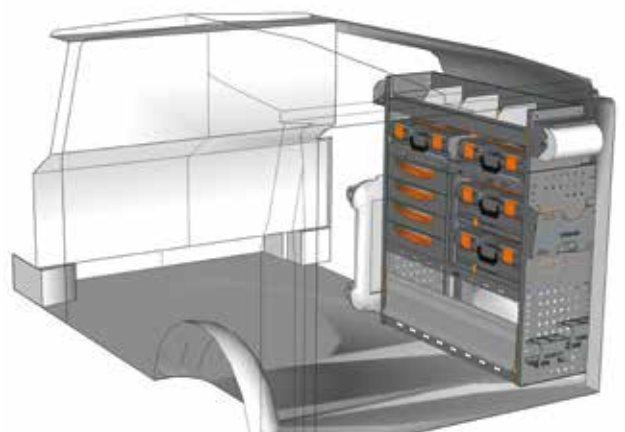
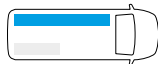

BEISPIEL - EXAMPLE

VT 1012 M1*

B=1016 T=365 H=1150 mm - W=1016 D=365 H=1150 mm

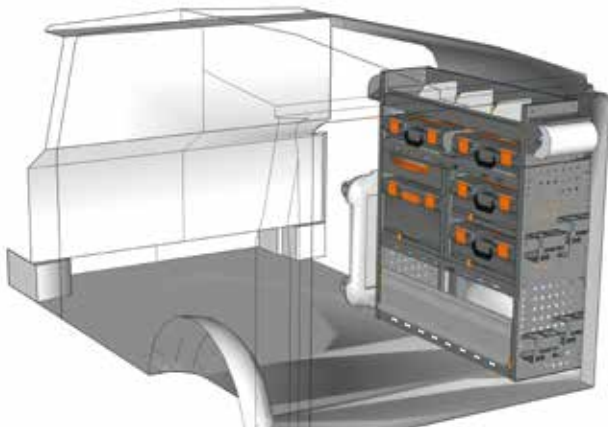

BEISPIEL - EXAMPLE

VT 1012 M2*

B=1016 T=365 H=1150 mm - W=1016 D=365 H=1150 mm

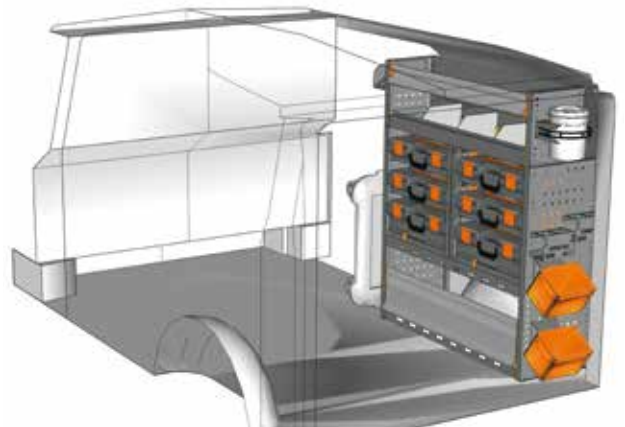
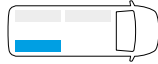

BEISPIEL - EXAMPLE

VT 1012 M3*

B=1016 T=365 H=1200 mm - W=1016 D=365 H=1200 mm



* Einschließlich Befestigungskit - Fixing kit included

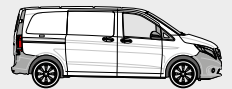

FAHRZEUGEINRICHTUNGSBEISPIELE - FITTINGS EXAMPLES

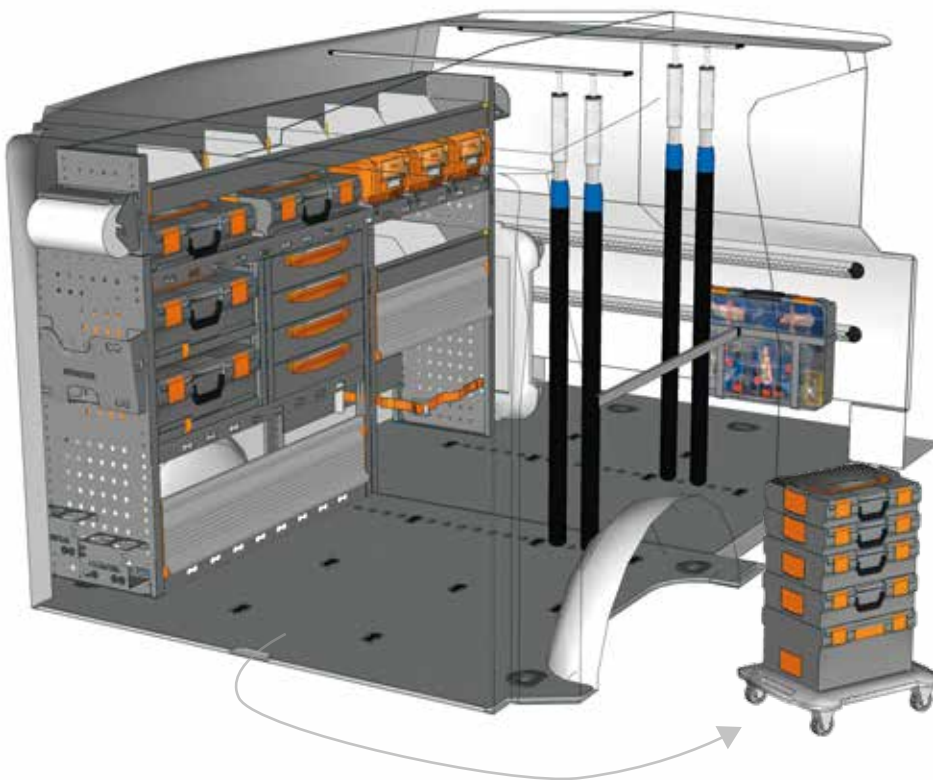

BEISPIEL - EXAMPLE

EXAMPLE VT L1H1 M1*



- | | |
|----------------|-------------|
| 1 x VT 1712 M1 | 1 x BOX080 |
| 1 x VT 10G1 A0 | 1 x CPV080 |
| 1 x V22585 | 2 x V22136 |
| 4 x V22131 | 2 x V22124 |
| 2 x V18029 15 | 2 x V22148 |
| 4 x V22106 | 1 x YELLOW |
| 3 x V18025 10 | 4 x V225820 |
| 6 x V23389 | |

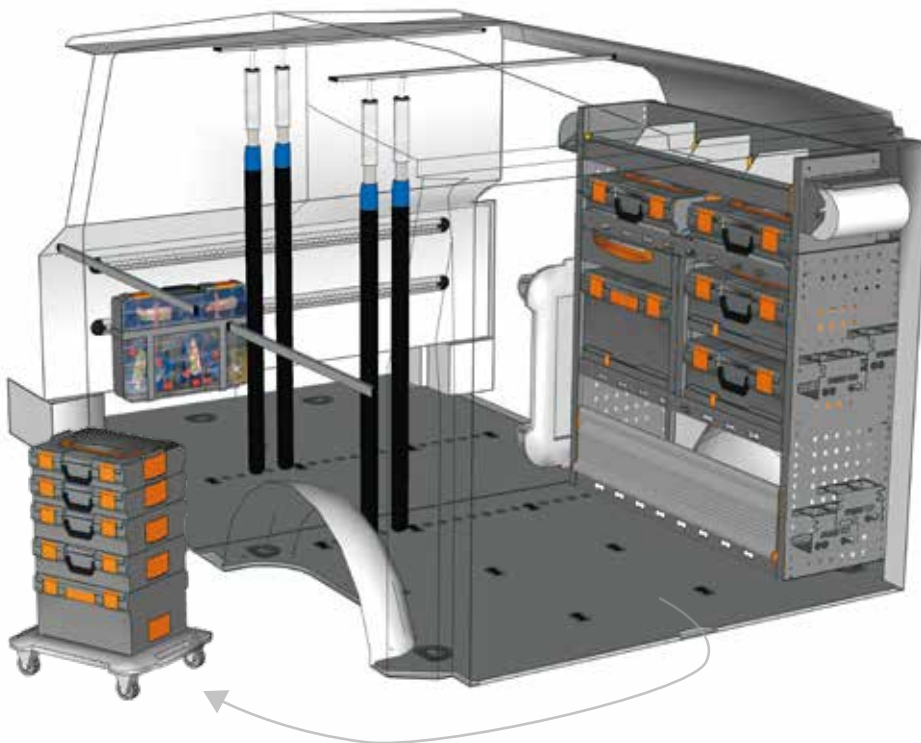

BEISPIEL - EXAMPLE

EXAMPLE VT L1H1 M2*



- | | |
|----------------|-------------|
| 1 x VT 1012 M2 | 1 x BOX080 |
| 1 x VT 10G1 A0 | 1 x CPV080 |
| 1 x V22585 | 2 x V22136 |
| 4 x V22131 | 2 x V22124 |
| 2 x V18029 15 | 2 x V22148 |
| 4 x V22106 | 1 x YELLOW |
| 4 x V18025 10 | 4 x V225820 |
| 8 x V23389 | |

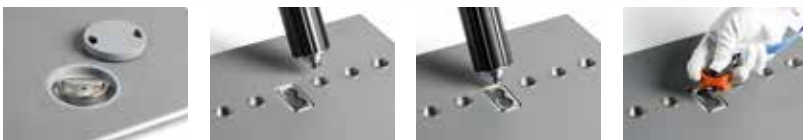

siehe Seiten 10/11
see pages 10/11

* Einschließlich Befestigungskit - Fixing kit included

Haben Sie Ihre Einrichtung nicht gefunden?
Verlassen Sie sich auf die Profis für Fahrzeugeinrichtungen.
Auf der Rückseite dieses Katalogs finden Sie die nächstgelegene StoreVan Niederlassung. Besuchen Sie unsere Web-Seite.

Didn't find the equipment you're looking for?
Leave it to our experts.
See the back of this catalogue and contact the nearest StoreVan point or visit our website.



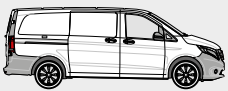

Lang - Long

MERCEDES-BENZ VITO
KASTENWAGEN - PANEL VAN

MOBILE

FAHRZEUGEINRICHTUNGSBEISPIELE - FITTINGS EXAMPLES

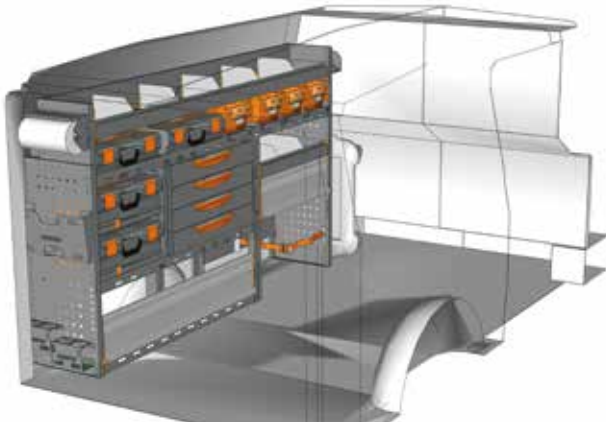

BEISPIEL - EXAMPLE

VT 1912 M1*

B=1942 T=365 H=1150 mm - W=1942 D=365 H=1150 mm

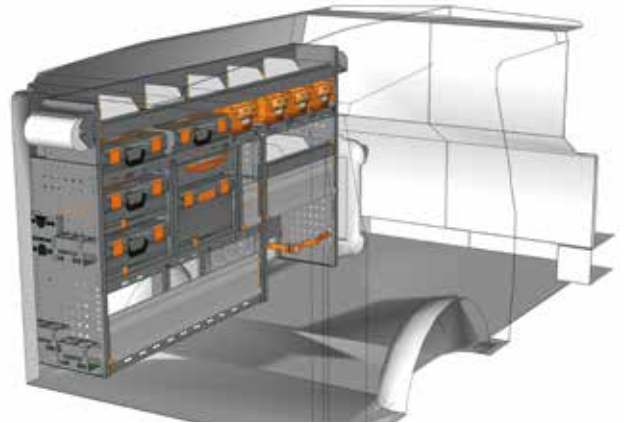
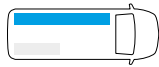

BEISPIEL - EXAMPLE

VT 1912 M2*

B=1942 T=365 H=1150 mm - W=1942 D=365 H=1150 mm

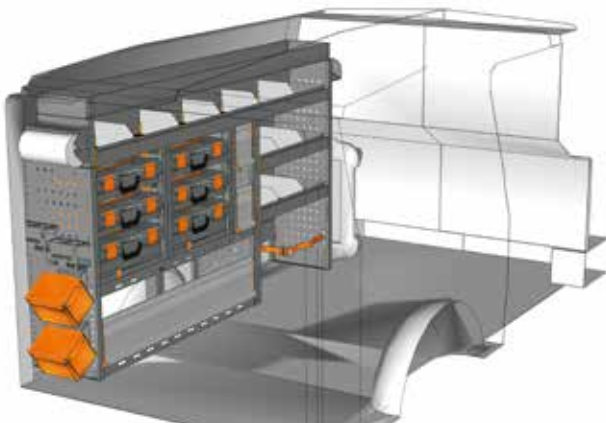

BEISPIEL - EXAMPLE

VT 1912 M3*

B=1942 T=365 H=1190 mm - W=1942 D=365 H=1190 mm

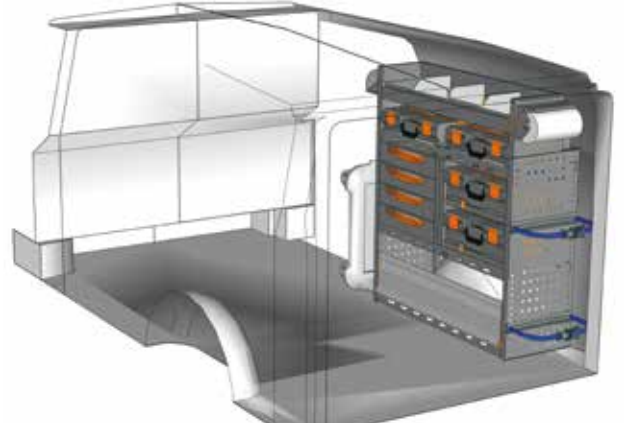
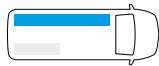

BEISPIEL - EXAMPLE

VT 1012 M4*

B=1016 T=365 H=1150 mm - W=1016 D=365 H=1150 mm

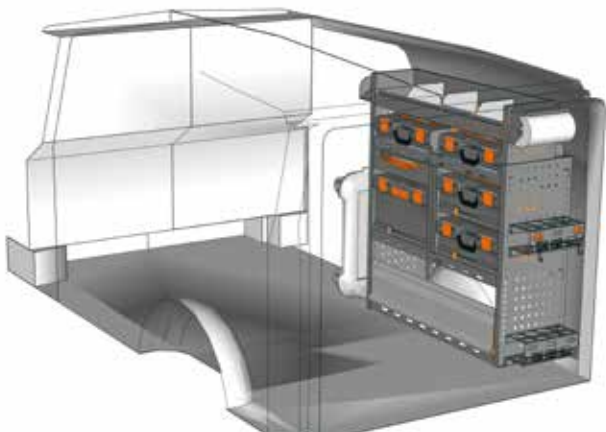

BEISPIEL - EXAMPLE

VT 1012 M5*

B=1016 T=365 H=1150 mm - W=1016 D=365 H=1150 mm

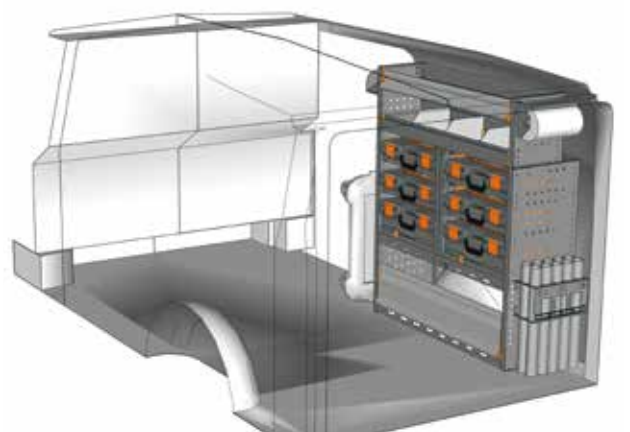
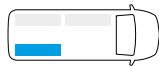

BEISPIEL - EXAMPLE

VT 1012 M6*

B=1016 T=365 H=1200 mm - W=1016 D=365 H=1200 mm



* Einschließlich Befestigungskit - Fixing kit included

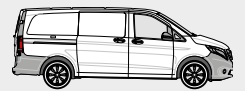

FAHRZEUGEINRICHTUNGSBEISPIELE - FITTINGS EXAMPLES

KASTENWAGEN - PANEL VAN
MERCEDES-BENZ VITO

MOBILE

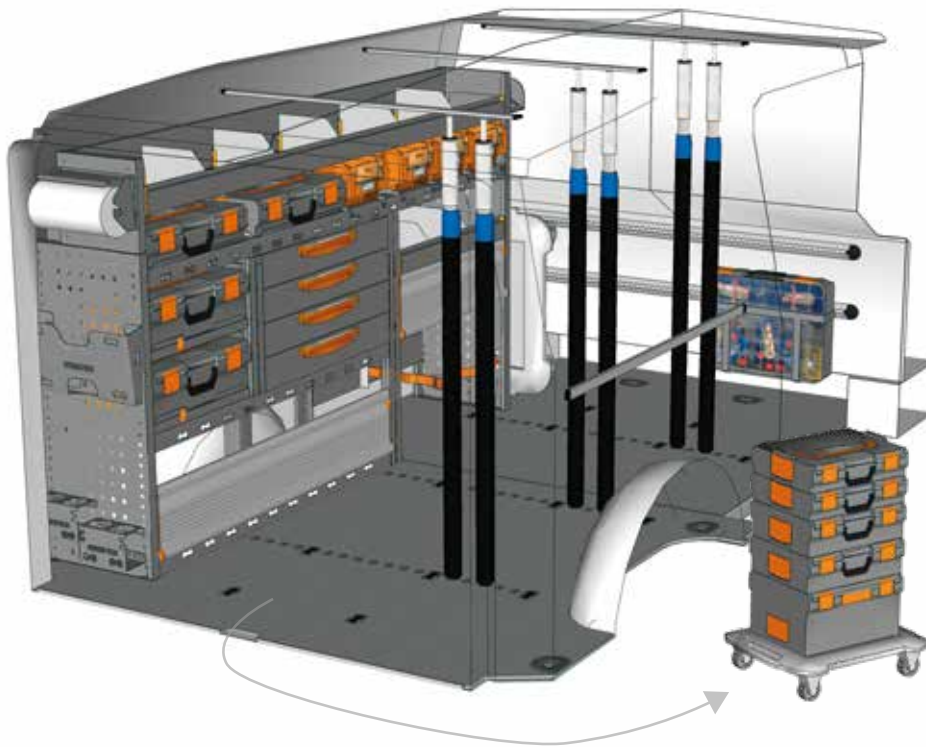

BEISPIEL - EXAMPLE

EXAMPLE VT L1LH1 M1*



- | | |
|----------------|-------------|
| 1 x VT 1912 M1 | 8 x V23389 |
| 1 x VT 1LG1 A0 | 1 x BOX080 |
| 1 x V22585 | 1 x CPV080 |
| 4 x V22131 | 2 x V22136 |
| 2 x V22735 | 2 x V22124 |
| 2 x V18029 15 | 2 x V22148 |
| 4 x V22106 | 1 x YELLOW |
| 4 x V18025 10 | 4 x V225820 |

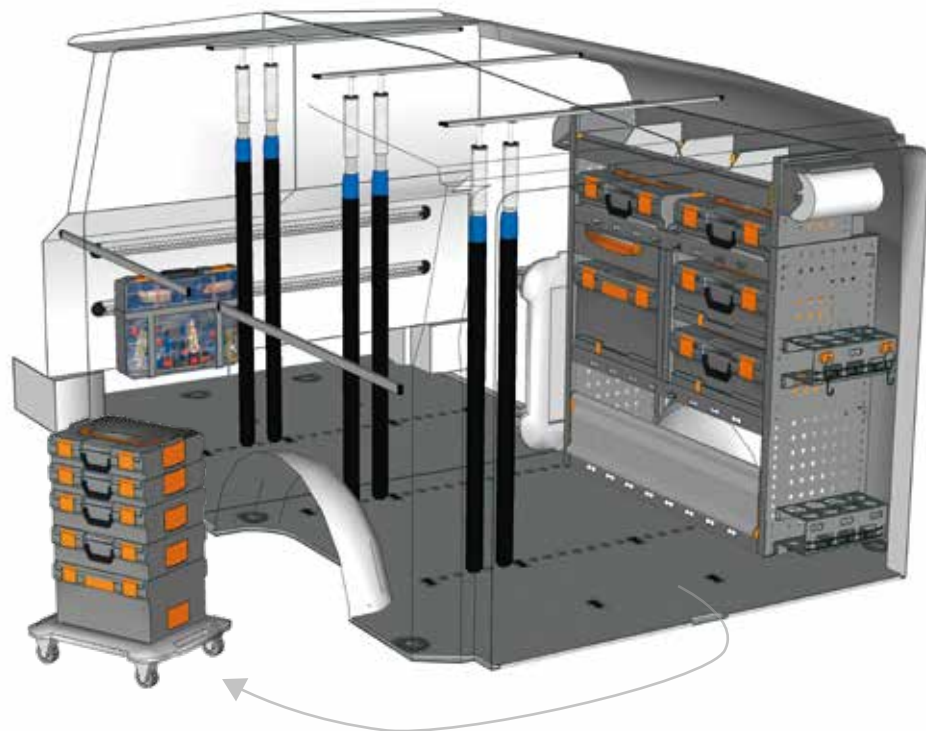

BEISPIEL - EXAMPLE

EXAMPLE VT L1LH1 M2*



- | | |
|----------------|-------------|
| 1 x VT 1012 M5 | 10 x V23389 |
| 1 x VT 1LG1 A0 | 1 x BOX080 |
| 1 x V22585 | 1 x CPV080 |
| 4 x V22131 | 2 x V22136 |
| 2 x V22735 | 2 x V22124 |
| 2 x V18029 15 | 2 x V22148 |
| 4 x V22106 | 1 x YELLOW |
| 5 x V18025 10 | 4 x V225820 |

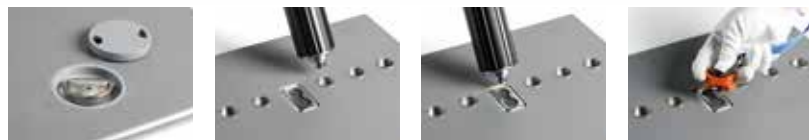

siehe Seiten 10/11
see pages 10/11

* Einschließlich Befestigungskit - Fixing kit included

Haben Sie Ihre Einrichtung nicht gefunden?
Verlassen Sie sich auf die Profis für Fahrzeugeinrichtungen.
Auf der Rückseite dieses Katalogs finden Sie die nächstgelegene StoreVan Niederlassung. Besuchen Sie unsere Web-Seite.

Didn't find the equipment you're looking for?
Leave it to our experts.
See the back of this catalogue and contact the nearest StoreVan point or visit our website.



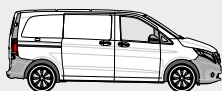

FAHRZEUG VEHICLE	DACHTRÄGER ROOF RACK	ABMESSUNGEN DIMENSIONS	GEWICHT WEIGHT	TRAGKRAFT LOAD CAPACITY
	ART.			
Fahrzeugtyp - Model Kompakt - Compact	VT 10H1 R1	2750x1600 mm	29,32 kg	120,00 kg
Fahrzeugtyp - Model Lang - Long	VT 1LH1 R1	3000x1600 mm	30,16 kg	119,00 kg
Fahrzeugtyp - Model Extralang - Extra Long	VT 20H1 R1	3400x1600 mm	31,74 kg	118,00 kg

POT

- Dachträger bestehend aus:
 - Alu-Querschienen inkl. Befestigungen und Gummiprofilen
 - Seitenwänden aus Aluminium
 - Laderolle aus Aluminium
 - Schraubmaterial aus Edelstahl

- Roof rack complete of:
 - aluminium crossbars with fixing parts and rubber profile
 - aluminium side rails
 - aluminium loading roller
 - fixing screws in stainless steel

- Nur für Fahrzeug mit Heckflügeltüren.
- Only for vehicle with rear leaf doors.

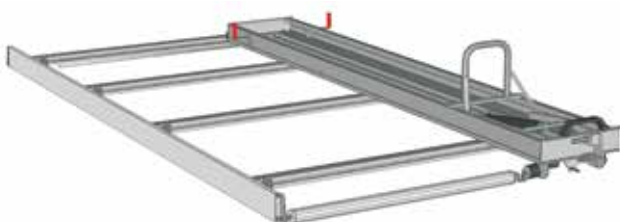

FAHRZEUG VEHICLE	LEITERTRÄGER LADDER RACK	ABMESSUNGEN DIMENSIONS	GEWICHT WEIGHT	TRAGKRAFT LOAD CAPACITY
	ART.			
Fahrzeugtyp - Model Kompakt - Compact	VT 10H1 L1	2750x1580 mm	54,13 kg	95,00 kg
Fahrzeugtyp - Model Lang - Long	VT 1LH1 L1	3000x1580 mm	56,16 kg	93,00 kg
Fahrzeugtyp - Model Extralang - Extra Long	VT 20H1 L1	3400x1580 mm	57,98 kg	92,00 kg

POS

- Leiterträger bestehend aus:
 - Alu-Querschienen inkl. Befestigungen und Gummiprofilen
 - Seitenwand aus Aluminium
 - Laderolle aus Aluminium
 - Leiterschiene aus Aluminium und Edelstahl
 - Schraubmaterial aus Edelstahl

- Ladder rack complete of:
 - aluminium crossbars with fixing parts and rubber profile
 - aluminium side rail
 - aluminium loading roller
 - ladder rack rail made of aluminium and stainless steel
 - fixing screws in stainless steel

- Nur für Fahrzeug mit Heckflügeltüren. Der Leiterträger kann links oder rechts montiert werden.
- Only for vehicle with rear leaf doors. The ladder rack rail can be mounted on the right or left side.





KASTENWAGEN - PANEL VAN
MERCEDES-BENZ VITO

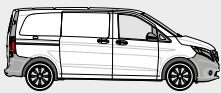

ART. NR. / ITEM NO. **PAP 265 00**

- Papierrollenhalter mit Papierrolle Ø 130 mm
- Paper towel holder kit with paper towel Ø 130 mm



ART. NR. / ITEM NO. **CAB 220 00**

- Schlauchhalter
- Cable saddle



ART. NR. / ITEM NO. **SPR 365 00**

- Spraydosenhalter T=365 mm
- Spray-can holder kit D=365 mm



ART. NR. / ITEM NO. **PAP 365 00**

- Papierrollenhalter mit Papierrolle Ø 240 mm
- Paper towel holder kit with paper towel Ø 240 mm



ART. NR. / ITEM NO. **CAB 296 00**

- Schlauchhalter-Satz
- Cable saddle-kit



ART. NR. / ITEM NO. **SIL 296 00**

- Kartuschen - Spraydosen halter
- Kit silicone - spray cans holder



ART. NR. / ITEM NO. **AID 265 00**

- Verbandkasten
- First aid kit



ART. NR. / ITEM NO. **DOC 365 00**

- Plantasche A4 - 362x68x209 mm H
- A4 documents holder - 362x68x209 mm H



ART. NR. / ITEM NO. **SPR 160 00**

- Satz 2-Stellen Spraydosenhalter
- Spray-can holder kit [2 slots]



ART. NR. / ITEM NO. **LED 001 00**

- Led Lampe IP20 12V B=600 mm
- Led lamp IP20 12V W=600 mm



ART. NR. / ITEM NO. **WAS 365 00**

- Handwasch Kit
- Hand wash kit



ART. NR. / ITEM NO. **WW MOBILE 1**

- Klapptisch Work Wood - 980x423x802 mm H
- Table with folding legs - 980x423x802 mm H

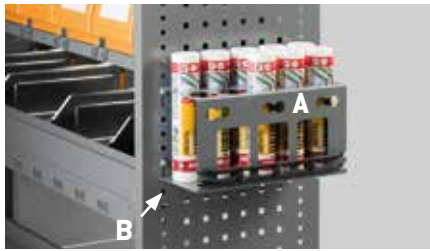
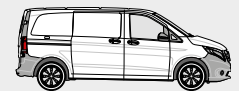

Kartuschenhalter
Kit silicone holder

A + B

ART. NR. / ITEM NO. **BAR 296 00**

A

- Träger für Silikon-Kartuschen- / Gewindestangenhalter
- Support for silicone cartridges / threaded-bar holder

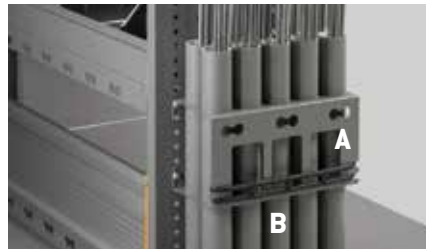

Gewindestangenhalter-Satz
Threaded-bar holder kit

A + B

ART. NR. / ITEM NO. **BAR 296 00**

A

- Träger für Silikon-Kartuschen- / Gewindestangenhalter
- Support for silicone cartridges / threaded-bar holder



ART. NR. / ITEM NO. **OIL 20L 00**

A

- Stahlkanister inhalt 20 LT
- Metal can capacity 20 LT

ART. NR. / ITEM NO. **BAR 296 02**

B

- Adapter für Silikon-Kartuschen
- Adapter for silicone cartridges

ART. NR. / ITEM NO. **BAR 296 01**

B

- 5 Rohren für Gewindestangenhalter
- 5 Pipe for threaded-bar holder

ART. NR. / ITEM NO. **OIL 365 00**

B

- Kanisterhalter
- Can holder

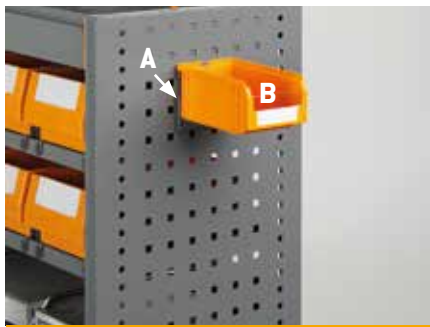

ART. NR. / ITEM NO. **BL 7433 00**

A

- Behälterschiene für 1 Behälter gröÙe 1PL
- Container rail for 1 container size 1PL

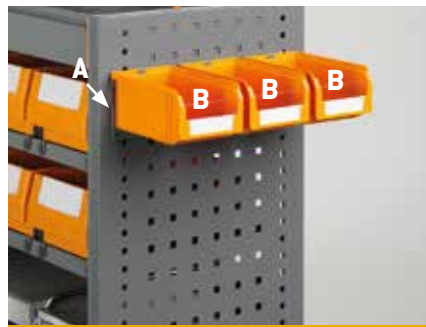

ART. NR. / ITEM NO. **BL 7434 00**

A

- Behälterschiene für 3 Behältern gröÙe 1PL
- Container rail for 3 containers size 1PL

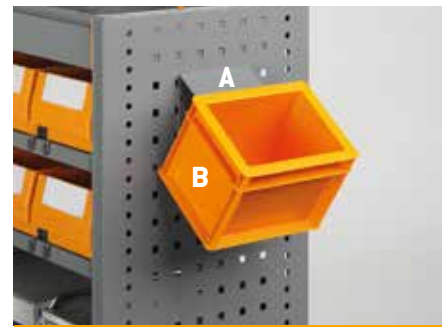

ART. NR. / ITEM NO. **BL 7432 00**

A

- Behälterschiene für 1 Behälter Euro Box
- Container rail for 1 container Euro Box

ART. NR. / ITEM NO. **PM 1751 00**

B

- Kunststoffbehälter gröÙe 1PL
- Polypropylene container size 1PL

ART. NR. / ITEM NO. **PM 1751 00**

B

- Kunststoffbehälter gröÙe 1PL
- Polypropylene container size 1PL

ART. NR. / ITEM NO. **PA 2251 A0**

B

- Kunststoffkasten aus Polypropilen serie Euro Box
- Polypropilene boxes series Euro Box



ART. NR. / ITEM NO. **MAG 020**

- Magnetensatz 10 Stk Ø 20 mm
- Set of 10 magnets Ø 20 mm



ART. NR. / ITEM NO. **RUB 160 00**

- Halter für Ladungssicherungspads
158x50x171 mm H
- Non-slip mats holder - 158x50x171 mm H



ANWENDUNGSBEISPIEL FÜR SATZ LADUNGSSICHERUNGSPADS

Die Antirutschmatten ermöglichen den Reibungswert bis zu μD 0.6 nach DIN EN 12195-1: 2004 und VDI 2700 ff zu erhöhen. Das Messverfahren befolgt die Richtlinie „VDI 2700 - 15“.

ART. NR. / ITEM NO. **MAG 025**

- Magnetensatz 10 Stk Ø 25 mm
- Set of 10 magnets Ø 25 mm

ART. NR. / ITEM NO. **RUB 000 00**

- Satz 6 Ladungssicherungspads - 150x150x3 mm H
- 6 non-slip mats kit - 150x150x3 mm H

USE CASE FOR NON-SLIP MAT

Non-slip mats are used to increase the coefficient of friction up to μD 0.6 following the calculus DIN EN 12195-1: 2004 and VDI 2700 ff. The measuring procedure should follow the directive "VDI 2700 - 15"

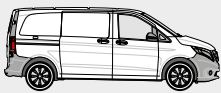

ART. NR. / ITEM NO. **FIR 000** A

- Gasflaschenhalter
- Gas cylinder kit

ART. NR. / ITEM NO. **FIR 4KG** B

- Feuerloescher (Pulver) 4 KG
- Fire extinguisher (powder) 4 KG



ART. NR. / ITEM NO. **V18029 03** A

- Horizontale Lasthalteschiene mit medium Lochung B=365 mm
- Horizontal load restraining bar with medium hole connector W=365 mm

ART. NR. / ITEM NO. **V18029 04** A

- Horizontale Lasthalteschiene mit medium Lochung B=445 mm
- Horizontal load restraining bar with medium hole connector W=445 mm

ART. NR. / ITEM NO. **V22868** B

- Zurrgurte mit Ratschenschloss mit medium Anschlussteil
- Medium connector ratchet load restraining belt

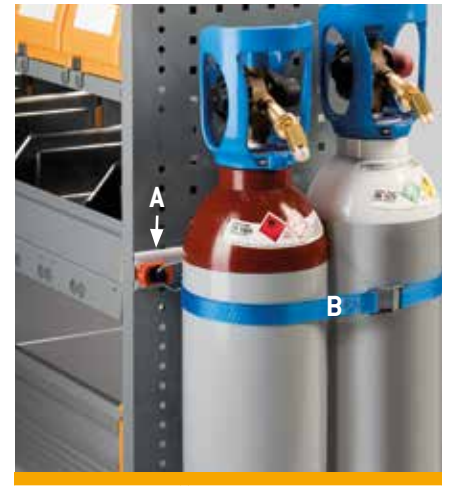

ART. NR. / ITEM NO. **V18029 03** A

- Horizontale Lasthalteschiene mit medium Lochung B=365 mm
- Horizontal load restraining bar with medium hole connector W=365 mm

ART. NR. / ITEM NO. **V18029 04** A

- Horizontale Lasthalteschiene mit medium Lochung B=445 mm
- Horizontal load restraining bar with medium hole connector W=445 mm

ART. NR. / ITEM NO. **V22869** B

- Zurrgurte mit Hebelspannschloss mit medium Anschlussteil
- Medium connector clamp load restraining belt



Beispiel mit
2 ART. NR. / ITEM NO. **FIR 000**
Example with
2 ART. NR. / ITEM NO. **FIR 000**



Beispiel mit
2 ART. NR. / ITEM NO. **V18029 03**
2 ART. NR. / ITEM NO. **V22868**
Example with
2 ART. NR. / ITEM NO. **V18029 03**
2 ART. NR. / ITEM NO. **V22868**



Beispiel mit
2 ART. NR. / ITEM NO. **V18029 03**
2 ART. NR. / ITEM NO. **V22869**
Example with
2 ART. NR. / ITEM NO. **V18029 03**
2 ART. NR. / ITEM NO. **V22869**

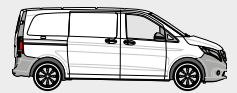

ART. NR. / ITEM NO. **00 ROLL SU** A

- Schienenträger-Satz für STORE BOX ROLL
- Set of supports for STORE BOX ROLL

ART. NR. / ITEM NO. **00 ROLL 00** B

- Plattform mit Rollen mit Bremsen für Koffer BOX 102-136-238-374
- Trolley with castors with brakes for tool case BOX 102-136-238-374



KASTENWAGEN - PANEL VAN
MERCEDES-BENZ VITO



MERCEDES-BENZ VITO

LIEFERBEDINGUNGEN

- Bodenplatten und Seitenverkleidungen werden in mehreren Teilen geliefert.
- Dachträger und Leiterträger werden **lose** geliefert.
- Module werden **vormontiert** komplett mit Fahrzeugbefestigungsmaterial geliefert.
- Produkte sollen vorzugsweise von **Vertragshändlern** installiert werden.
- Produkte werden **verpackt** geliefert.
- **3 Jahre Garantie** auf unsere Komponenten.
- Die Tragkräfte beziehen sich auf **gleichmäßig verteilte Last**.

SUPPLY CONDITIONS

- Flooring and linings supplied in several pieces.
- Roof and ladder racks supplied **flat-packed**.
- Modules are supplied **preassembled** complete of fixing material to the vehicle.
- For products installation, please get in touch with our **approved installer's network**.
- Products provided **with packaging**.
- Our products are covered by a **3-years warranty**.
- Load capacities refer to **uniformly distributed loads**.



FAMI S.R.L.

VIA STAZIONE ROSSANO, 13 – 36027 ROSÀ (VI) ITALY
TEL +39 0424 585455 R.A. – FAX +39 0424 585482
INFO@FAMISPA.COM – WWW.FAMISPA.COM

INFO@STOREVAN.COM – WWW.STOREVAN.COM

