



FAHRZEUGEINRICHTUNGEN
FITTINGS FOR COMMERCIAL VEHICLES



OPEL COMBO





StoreVan ist weltweit der einzige Hersteller von Nutzfahrzeugeinrichtungen, der mit dieser Technologie arbeitet.

StoreVan is the sole LCV's equipment manufacturer worldwide to make use of this technology.

TECHNOLOGIE

GALVANNEALED STAHL

Galvannealed Blech ist eine Variante von feuerverzinktem Blech. Das Produkt unterliegt einem Feuerbeschichtungsprozess und wird bis ca. 550 °C erhitzt. Dies ermöglicht es dem Zink mit dem Stahlblech eine Legierung einzugehen. Das Ergebnis ist eine Beschichtung mit einer gleichförmigen, feinkörnigen Kristallstruktur an der Beschichtungsoberfläche und einer **sehr hohen Oberflächenqualität und Korrosionsbeständigkeit**.

Dieses Verfahren ist ideal für Automotive Anwendungen. StoreVan hat diese Technik nun auch im Bereich Nutzfahrzeugeinrichtungen implementiert.

DAS VERFAHREN DER KATHODISCHEN ACRYL-TAUCHLACKIERUNG

Die kathodische Acryl-Beschichtung ist eine Oberflächenbehandlung, die den einzelnen Teilen der Einrichtung eine **extrem hohe Korrosionsbeständigkeit** verleiht. Das Tauchverfahren gewährleistet eine **gleichmäßige Beschichtung** und einen lang anhaltenden Schutz egal gegen welche Stoffe. Das Acrylharz schützt den Lack bei direkter Belichtung durch die Witterung gegen Ausbleichen und gegen Veränderungen der Korrosionsbeständigkeit.

- Korrosionsbeständigkeit von über 500 Stunden (ASTM D1735 Luftfeuchtigkeit)
- Ausgezeichnete Härte mit einem Mindestrating von 2H



STORE VAN ORANGE PLANET

Nachhaltigkeit und ökologische Entwicklung sind Themen von großem, aktuellem Interesse, entstanden durch das steigende Bewusstsein, dass auf die Umweltbalance aufgrund der zyklischen Veränderungen und Erneuerungen geachtet werden muss.

STORE VAN ORANGE PLANET

Environmental sustainability and eco-compatible development are topics of great interest and relevance, arising from the growing awareness that it is important to pay attention to the environmental balance.

TECHNOLOGIES

GALVANNEALED STEEL

Galvannealed sheet is a variant of hot-dip galvanized sheet. The product is subject to a hot-dip galvanization process and subsequently heated to approximately 550°C, combining the zinc with the sheet surface to make an alloy with iron. The result is a uniform zinc coating with a fine-grained crystalline structure along with a **much higher surface quality and corrosion resistance**. This process is ideal for automotive applications. StoreVan has introduced and implemented this technology in the commercial vehicles equipment field.

CATHODIC DIP PAINTING WITH ACRYLIC RESIN

Cataphoresis painting is a paint surface treatment able to give the equipment elements a **remarkable resistance to corrosion**; characterized by **uniform deposit** of an acrylic resin on the element surface, it ensures long lasting, high protection against chemical agents and other types of surface attacks. The acrylic resin allows a direct exposure to atmospheric agents without altering its technical features. This process ensures an increased protection against rust.

- Corrosion resistance of more than 500 hours (humidity ASTM D1735)
- Excellent hardness with a minimum rating of 2H



FLEXIBLES BEFESTIGUNGSSYSTEM

FLEXIBLE FIXING SYSTEM

DIE FLEXIBILITÄT UND DAUERHAFTIGKEIT DER STORE VAN TRANSPORTEREINRICHTUNGEN

Store Van benutzt zur Befestigung der Transporterregale am Fahrgestell des Nutzfahrzeuges ein spezielles Schienensystem und sorgt damit für eine besonders flexible Positionierbarkeit der Module und eine maximale Nutzung der Innenräume des ausgestatteten Transporters.

Bei diesem System werden Bügel benutzt, die in der Gesamtlänge der Schiene gleiten, anstatt direkt an den Verstärkungen des Fahrgestells angenietet zu sein, was beim Entwurf der Transportereinrichtung grundsätzlich zu einer starren Raumnutzung zwingt. Die von Store Van verwendete Schiene wird an die vertikalen Pfosten der mobilen Werkstatt befestigt und hat die doppelte Funktion einer gleichmäßigen Verbindung der Transporterregale am Fahrzeugrahmen und einer homogenen Verteilung aller dynamischen Kräfte, denen die Einrichtung während der Fahrt ausgesetzt ist.

Die Befestigungsbügel für die Verbindung der Schiene am Modul besitzen ein spezielles Gelenk, das die bei der Fahrt verursachten Vibrationen dämpft, indem es sich den Torsionsbewegungen des Fahrgestells anpasst, vor allem beim Kurvenfahren.

Dieses System bietet beim Entwurf unserer Transportereinrichtungen eine erhebliche Gestaltungsfreiheit, wobei in jedem Fall hohe Sicherheits-, Stabilitäts- und Dauerhaftigkeitsstandards garantiert werden.

Bei allen unseren Befestigungssystemen können für die Module Schnellankupplungs- und -loskupplungssysteme mit Feststellgriffen eingesetzt werden, die eine werkzeuglose Demontage der Einrichtung ermöglichen. Dadurch kann das Regal Ihrer mobilen Werkstatt, wie in der RICHTLINIE 2014/47 EU, KAP. 1, Artikel 3, Absatz 5 beschrieben, als transportiertes Material oder als Hilfsmittel für die Sicherheit der nicht dauerhaft am Fahrzeug befestigten Ladung erklärt werden.

FLEXIBILITY AND DURABILITY OF STORE VAN EQUIPMENT

Store Van uses a special rail anchoring system to secure shelving units for vans to the chassis of your vehicle, improving the flexibility of module arrangement and maximising the internal spaces of your van.

This system is based on brackets sliding all along the rail rather than being riveted to chassis reinforcements, thus offering great flexibility in the management of internal spaces. The Store Van rail is secured to the uprights of your mobile workshop and has a two-fold function: it connects shelving units uniformly to the frame of your vehicle, and it evenly distributes all the dynamic forces your van equipment is subject to while travelling. Special vibration damping joints, fitted on the brackets connecting the rail to the module, absorb the torsional vibration applied on the chassis especially when driving on a curve.

Thanks to this system, our fittings for vans can be designed with maximum freedom, always ensuring high safety, stability and durability standards.

Our anchoring systems are fitted with quick locking/unlocking devices with adjustable handles, so users can remove the fittings with no need of tools. Hence the shelving units of your mobile workshop may be considered as transported goods or load securing fittings not permanently fixed to the vehicle, in compliance with Directive 2014/47EU, Chapter 1, Article 3, Item 5.



ZERTIFIZIERUNGEN CERTIFICATIONS

ZERTIFIZIERTE PRODUKTION

- Nach ISO 9001:2015 zertifiziert.
- Erfolgreicher CRASH TEST durchgeführt nach ECE-R17 mit einer Aufprallgeschwindigkeit von 50 Km/h.
- GS-Zertifizierung für Inneneinrichtungen und Laderampen.
- GS-Zertifizierung für Dachträger und Leiterträger.

CERTIFIED PRODUCTION

- ISO 9001:2015 certified.
- Brilliantly passed the CRASH TEST carried out according to the most recent European regulations ECE-R17 with impact at 50 Km/h.
- GS certification for interior fittings and loading ramps.
- GS certification for roof and ladder racks.

CRASH TEST
ECE-R17



Grundlage für den sicheren Schutz von Fahrzeugen

Base for the safe protection of vehicles

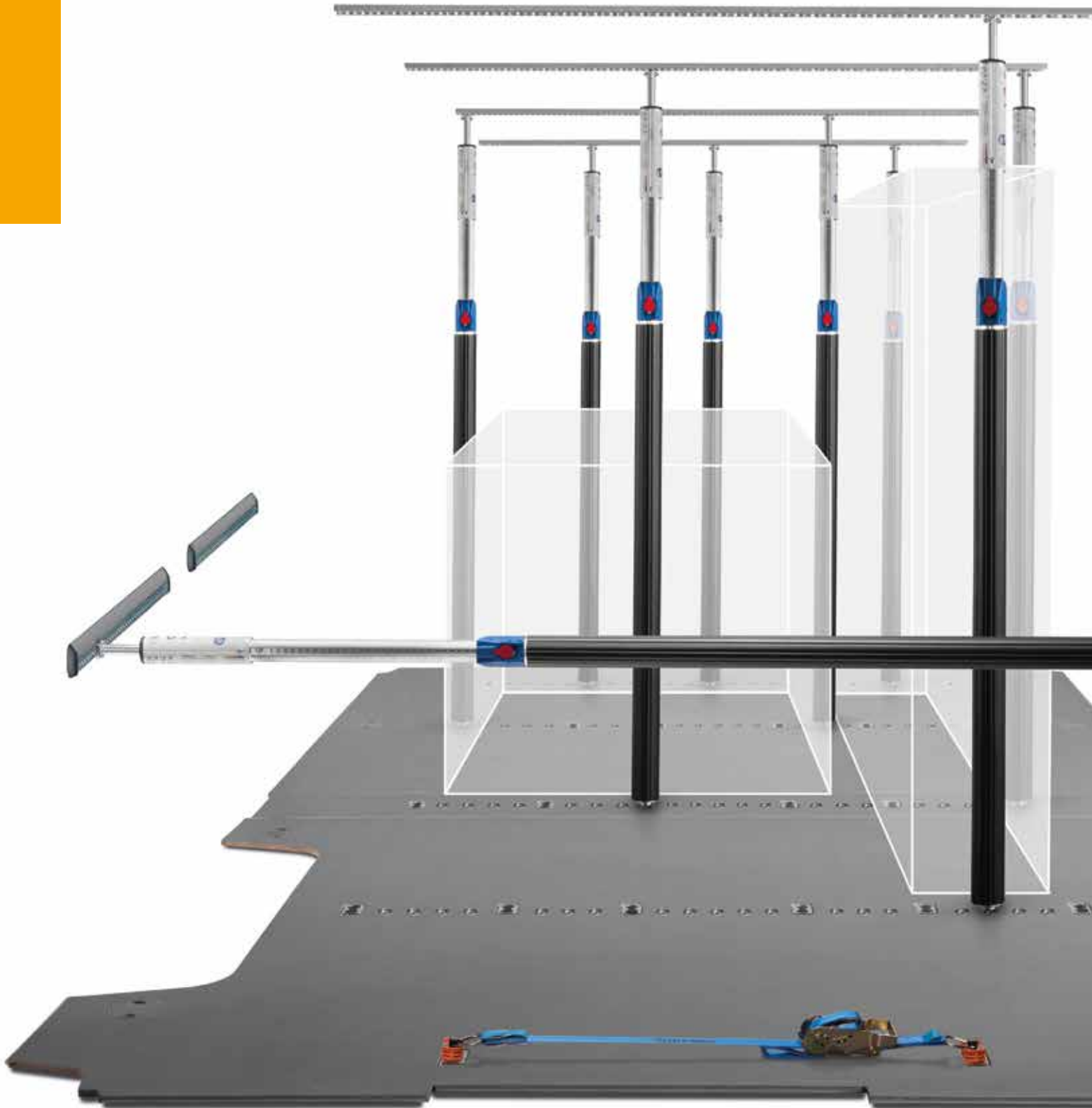

LADUNGSSICHERUNG FÜR TRANSPORTER UND SICHERE BEFESTIGUNG DER WAREN

Durch die Umsetzung der Richtlinie 2014/47/EU wird eine Intensivierung der Kontrollen an Kraftfahrzeugen für die Güterbeförderung der Klassen N2 und N3 und eine aufmerksamere Kontrolle der Ladungssicherung erfolgen. Die Richtlinie ermöglicht es den Mitgliedsstaaten, Fahrzeuge, die über den Anwendungsbereich hinausgehen, wie z.B. Nutzfahrzeuge der Klasse N1, technischen Kontrollen zu unterziehen, sowie weitere Aspekte des Transports und der Straßenverkehrssicherheit zu kontrollieren.

SCHUTZSYSTEM DES LADERAUMS UND LADUNGSSICHERUNG

Das neue integrierte Transporter-Schutzsystem von Store Van folgt den Leitlinien der neuen Richtlinie 2014/47/EU und erlaubt eine **flexible und sichere Befestigung** der Ladung an den Ladeflächen und Innenwänden des Fahrzeugs.

Mit den „Airline“ Festhaltekomponenten und dem Einbau zahlreicher Zubehörteile wie Riemen, Netze und teleskopische Spannstrangen kann der Fahrzeugbenutzer seine Festhalteplattform einfach, ergonomisch und in Entsprechung der europäischen Richtlinien gestalten.

Das System umfasst die folgenden Bestandteile:

- Mehrschichtige Bodenplatten für Transporter mit Phenolharzverleimung, mit eingelassenen Aufnahmen für die Originalverankerungen des Fahrzeugs und mit zusätzlichen bodenplattenflächigen Verankerungen (S. 10) mit einer Zugkraft von 200 daN;
- am Fahrgestell verankerte „Airline“ Aluminiumschienen (S. 11);
- hochflexible und hochresistente Polypropylenpaneele für den internen Schutz der Karosserie vor Stößen (S. 8).

DAS ANBRINGEN DES NEUEN SCHUTZSETS SORGT FÜR EINE LANGE REIHE VON VORTEILEN:

- Der Fahrzeugbenutzer kann die Ladung schon mit den Zurrgurten sicher an den „Airline“ Schienen befestigen.
- Das integrierte Befestigungsset hält die Karosserie länger in gutem Zustand.
- Das Schutzsystem verleiht einen Mehrwert, der schon auf dem Markt der Neufahrzeuge sehr wichtig erscheint und bei Gebrauchtfahrzeugen, die normalerweise Karosserieschäden aufweisen, sogar von grundlegender Bedeutung ist.



VAN LOAD SECURING AND CARGO RESTRAINT

Transposition of directive 2014/47/EU will intensify control of N2 and N3 category transport vehicles and cargo securement enforcement. Under this Directive, the Member States can subject vehicles that are beyond the scope of the Directive, such as N1 category vehicles, to technical inspections, and also monitor other transport and road safety aspects.

CARGO AREA PROTECTION SYSTEM AND CARGO RESTRAINT

The new Store Van integrated system for van protection follows the guidelines of Directive 2014/47/EU while making the **anchoring of the cargo to the van floor and walls flexible and safe.**

With the use of „Airline“ securing components and integration of many different accessories such as belts, nets and telescopic load restraining bars, final users may configure their cargo platform easily and cheaply and in conformity with the European Directive.

The system uses:

- phenolic resin plywood floor panels, arranged to fit original anchoring fittings and additional 200 daN strength lashing points (page 10), flush with the floor panel;
- aluminium „Airline“ bars anchored to the chassis (page 11);
- highly flexible and resistant polypropylene panelling to protect the internal body shell from accidental impacts (page 8).

THE NEW LOAD SECURING SYSTEM OFFERS NUMEROUS ADVANTAGES:

- users can safely secure the load to the „Airline“ bars with load restraining belts;
- the integrated load securing system extends the body's good condition over the time;
- the protection system offers new added value, an important economic aspect for a new vehicle and a fundamental characteristic for a second-hand vehicle, that is usually exposed to damage.

SAFETY CROSS: Fixierpunkte in Längs- und Querrichtung nach Anfrage.
SAFETY CROSS: longitudinal and transversal fixing points upon request.



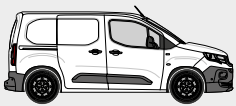

- Seitenverkleidungen für Fahrzeug mit rechter Schiebetür und Seitenwänden aus Vollblech.
- Linings for right side door vehicle with metal sheet sidewalls.



HONEYCOMB PANEL - A

- Seitenverkleidung aus Polypropylen für:
 - linke Seitenwand
 - rechte Seitenwand und Schiebetür
- Polypropylene linings for:
 - LH sidewall
 - RH sidewall and sliding door

HONEYCOMB PANEL - C

- Seitenverkleidung aus Polypropylen für:
 - oberen Teil der Heckflügeltüren
- Polypropylene linings for:
 - upper part of rear hinged doors

FAHRZEUG VEHICLE	SEITENVERKLEIDUNG LINING	
	A	C
	ART. NR. / ITEM NO.	ART. NR. / ITEM NO.
Fahrzeugtyp - Model L1 H1	PA 10H1 A1 3,35 kg	PA DRH1 A0 0,97 kg
Fahrzeugtyp - Model L2 H1	PA 20H1 A1 3,97 kg	PA DRH1 A0 0,97 kg

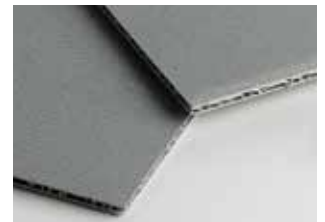



- Bodenplatte für Fahrzeug mit rechter Schiebetür und Seitenwänden aus Vollblech.
- Flooring for right side door vehicle with metal sheet sidewalls.



WOOD FLOOR - D

- Bodenplatte aus Multiplex mit Phenolbeschichtung, Stärke 9 mm, für das Originalverankerungssystem des Fahrzeugs vorgebohrt.
- 9 mm thick wooden flooring with phenolic coating set for the vehicle original anchoring system

KASTENWAGEN - PANEL VAN
OPEL COMBO

WF

FAHRZEUG VEHICLE	BODENPLATTE 9 mm 9 mm FLOORING
	D
	ART. NR. / ITEM NO.
Fahrzeugtyp - Model L1	PA 10D1 B1 14,64 kg
Fahrzeugtyp - Model L2	PA 20D1 B1 17,83 kg



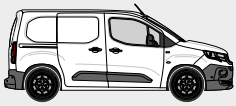

- Bodenplatte für Fahrzeug mit rechter Schiebetür und Seitenwänden aus Vollblech.
- Flooring for right side door vehicle with metal sheet sidewalls.

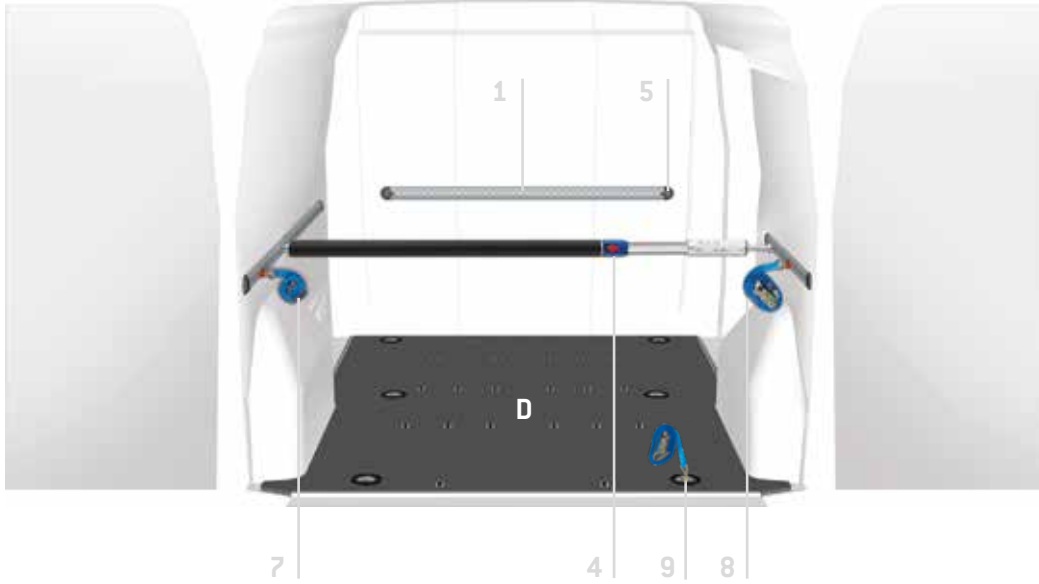

SAFETY FLOOR - D

- Bodenplatte 9 mm aus phenolbeschichtetem Holz mit zusätzlichem Einzelzurrpunktensystem.
- 9 mm phenol faced plywood flooring with additional lashing points

**FAHRZEUG
VEHICLE**

**BODENPLATTE 9 mm
FLOORING 9 mm**

D

ART. NR. / ITEM NO.

**Fahrzeugtyp - Model
L1**

**PA 10K1 B1
16,44 kg**

**Fahrzeugtyp - Model
L2**

**PA 20K1 B1
19,82 kg**

Die Bodenplatte muss auf den Fahrzeugboden aufgeklebt sein.
The floor must be glued to the vehicle



- Silikonklebstoff für Bodenplatten.
- Silicone glue for flooring.

ART. NR. / ITEM NO. V22585



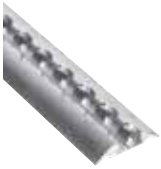
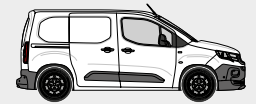

- Horizontale Aluschiene.
- Horizontal aluminium bar.

1

ART. NR. / ITEM NO.

- V18029 05** Länge - Length 500 mm
- V18029 10** Länge - Length 1000 mm
- V18029 15** Länge - Length 1500 mm
- V18029 20** Länge - Length 2000 mm
- V18029 25** Länge - Length 2500 mm



- Teleskopische Spannstange.
- Telescopic load restraining bar.

4

ART. NR. / ITEM NO.

- V22149** Länge - Length 650-900 mm
- V22734** Länge - Length 850-1100 mm
- V22735** Länge - Length 1050-1300 mm
- V22131** Länge - Length 1250-1750 mm
- V22017** Länge - Length 1550-2050 mm
- V22086** Länge - Length 2000-2500 mm



- Endstück aus Kunststoff für Aluschiene Serie V18029.
- Plastic end cap for bar series V18029.

5

ART. NR. / ITEM NO.

V22106



- Horizontale Aluschiene.
- Horizontal aluminium bar.

2

ART. NR. / ITEM NO.

- V18025 05** Länge - Length 500 mm
- V18025 10** Länge - Length 1000 mm
- V18025 15** Länge - Length 1500 mm
- V18025 20** Länge - Length 2000 mm



- Zurring.
- Ring stud fitting.

6

ART. NR. / ITEM NO.

V225820



- Zurring mit Hebelspannschloss 2500+500.
- Load restraining belt with clamp 2500+500.

7

ART. NR. / ITEM NO.

V22136



- Endstück aus Kunststoff für Aluschiene Serie V18025.
- Plastic end cap for bar series V18025.

10

ART. NR. / ITEM NO.

V23389



- Horizontale Aluschiene.
- Horizontal aluminium bar.

3

ART. NR. / ITEM NO.

- V18030 10** Länge - Length 1000 mm
- V18030 15** Länge - Length 1500 mm
- V18030 20** Länge - Length 2000 mm
- V18030 25** Länge - Length 2500 mm
- V18030 30** Länge - Length 3000 mm



- Zurring mit Ratschenschloss 2500+500.
- Load restraining belt with ratchet 2500+500.

8

ART. NR. / ITEM NO.

V22124



- Zurring mit Ratschenschloss 4500+500.
- Load restraining belt with ratchet 4500+500.

9

ART. NR. / ITEM NO.

V22148



- Beispiel von Ladungssicherungskoffer-kit.
- Example of tool case for load securing.



1 ART. NR. / ITEM NO.
BOX080

B=440 T=350 H=80 mm
W=440 D=350 H=80 mm



2 ART. NR. / ITEM NO.
V22136



1 ART. NR. / ITEM NO.
CPV080



2 ART. NR. / ITEM NO.
V22124



4 ART. NR. / ITEM NO.
V225820



2 ART. NR. / ITEM NO.
V22148



1 ART. NR. / ITEM NO.
YELLOW

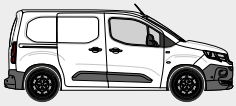

BESTANDTEILELISTE SEITENWANDVERKLEIDUNGEN - LININGS LEGEND

OPEL COMBO

KASTENWAGEN - PANEL VAN

HONEYCOMB
PANEL

HP

- Für Fahrzeug mit rechter Schiebetür und Seitenwänden aus Vollblech.
- For right side door vehicle with metal sheet sidewalls.

Fahrzeugtyp - Model

L1 H1

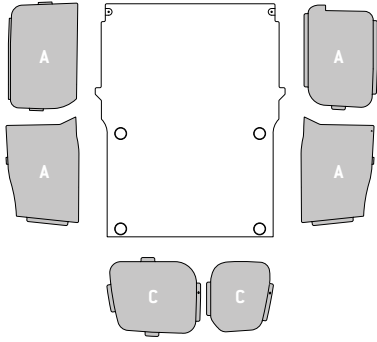

Fahrzeugtyp - Model

L2 H1

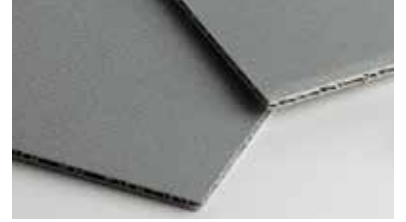
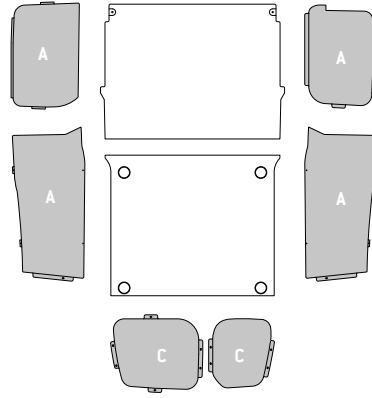

SAFETY CROSS: Fixierpunkte in Längs- und Querrichtung nach Anfrage.
SAFETY CROSS: longitudinal and transversal fixing points upon request.

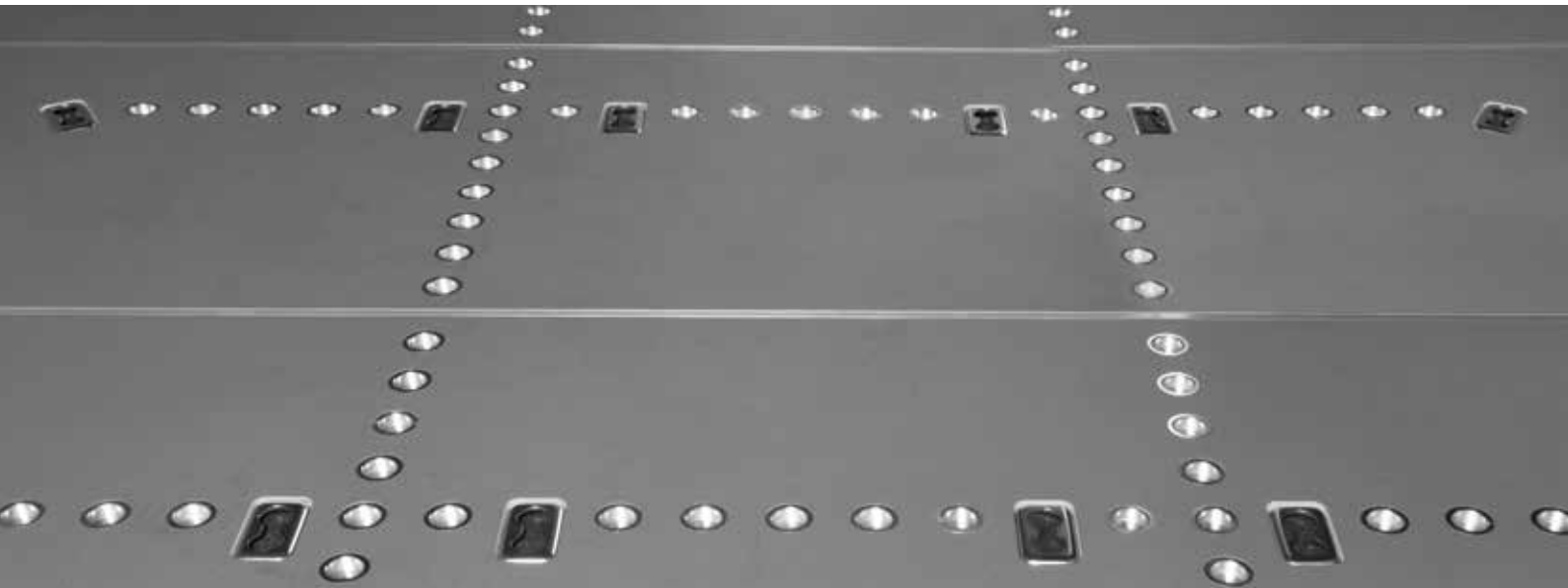

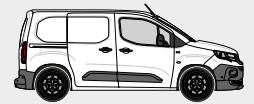

- Für Fahrzeug mit rechter Schiebetür und Seitenwänden aus Vollblech.
- For right side door vehicle with metal sheet sidewalls.

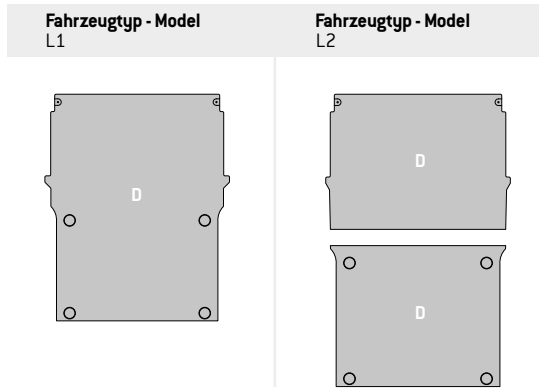

KASTENWAGEN - PANEL VAN
OPEL COMBO

WOOD
FLOOR
WF

- Für Fahrzeug mit rechter Schiebetür und Seitenwänden aus Vollblech.
- For right side door vehicle with metal sheet sidewalls.

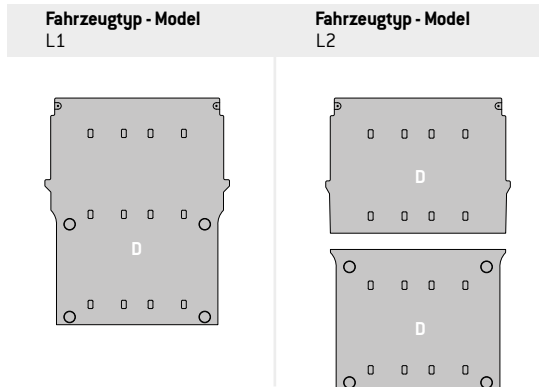

- Jede Reihe von Verankerungspunkten für jede Bodenplatte besteht aus 4 "Airline" Einzelzurrpunkten.
- In each flooring, each lashing row is composed of 4 "Airline" lashing points.

SAFETY
FLOOR
SF

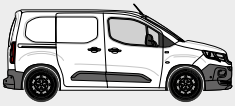

**Serienmäßig mit
Ladungssicherung**

**Factory-fitted load
securing**

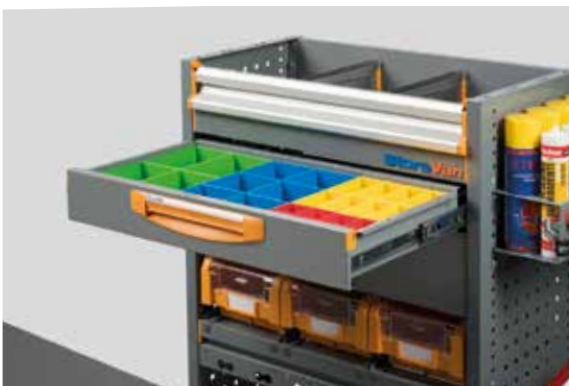

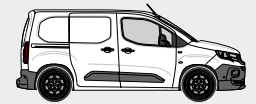

Die Lösungen der **SAFETY Transportereinrichtungen** von Store Van erfüllen die Erfordernisse der neuen Ladungssicherungsbestimmungen. In die Module werden Strukturelemente eingebaut, die eine Nutzung der „Airline“ Festhaltesysteme wie Gurte, Netze und teleskopische Spannstangen erlauben. Dieses neue Niveau der **Einrichtungen für Nutzfahrzeuge** erleichtert das Verankern von mittelgroßen und kleinen Gegenständen, selbst wenn die Transporter-Bodenplatten nicht mit Verankerungssystemen ausgestattet sind, und garantiert dadurch die Ladungssicherung. Die „Airline“ Verankerungselemente des SAFETY-Niveaus erhöhen die Stabilität der Module ohne Gewichtszunahme, denn sie in der Struktur der Einrichtung integriert sind.

The Store Van **SAFETY equipment solution** meets the requirements of the new cargo restraint regulations. Our modules are integrated with structural elements where “Airline” anchoring fittings, such as belts, nets and telescopic bars can easily fit. This new equipment for commercial vehicles simplifies the securing of medium-sized or small parts, even if the floor panel of your van has no anchoring systems, to guarantee maximum load securing. The “Airline” anchoring fittings for SAFETY equipment improve the stability of modules with no weight increase, because they are built in the equipment structure.



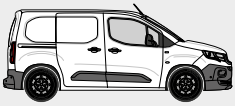

L1 H1

OPEL COMBO
KASTENWAGEN - PANEL VAN

SAFETY

FAHRZEUGEINRICHTUNGSBEISPIELE - FITTINGS EXAMPLES

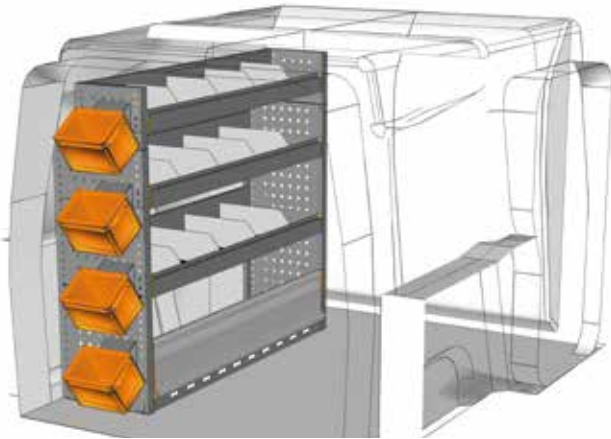

BEISPIEL - EXAMPLE

PA 1211 11*

B=1225 T=365 H=1100 mm - W=1225 D=365 H=1100 mm

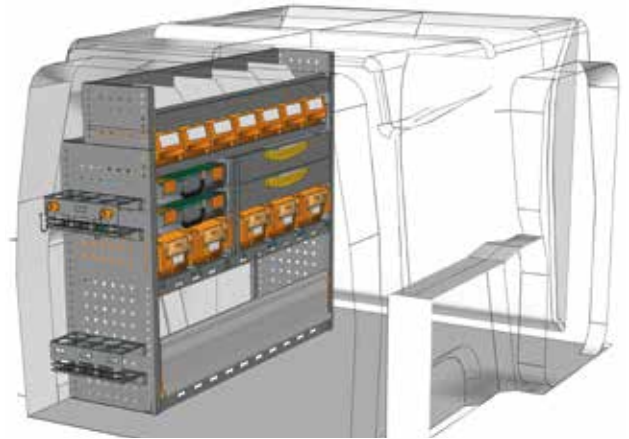

BEISPIEL - EXAMPLE

PA 1211 12*

B=1225 T=365 H=1100 mm - W=1225 D=365 H=1100 mm

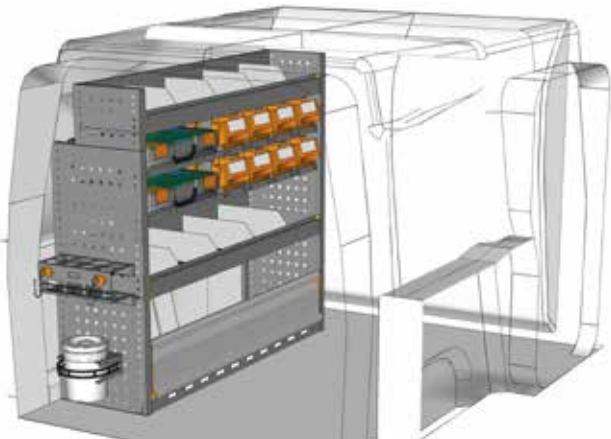

BEISPIEL - EXAMPLE

PA 1211 13*

B=1225 T=365 H=1100 mm - W=1225 D=365 H=1100 mm

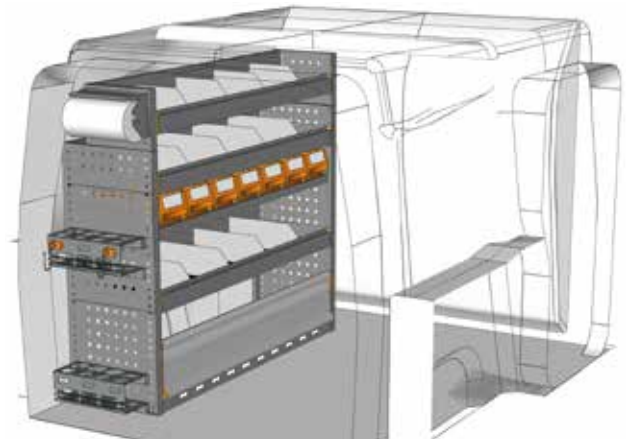

BEISPIEL - EXAMPLE

PA 1211 14*

B=1225 T=365 H=1100 mm - W=1225 D=365 H=1100 mm

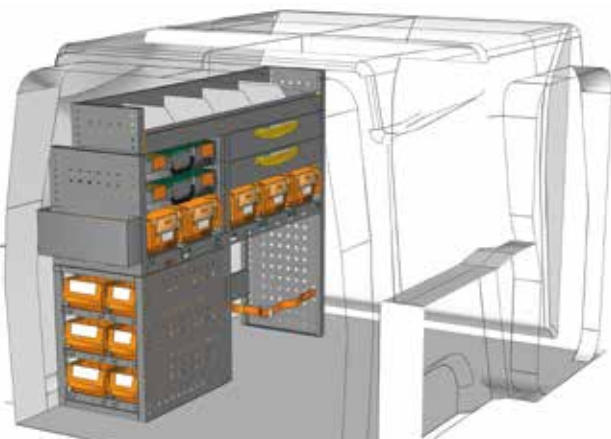

BEISPIEL - EXAMPLE

PA 1211 15*

B=1225 T=365 H=1050 mm - W=1225 D=365 H=1050 mm

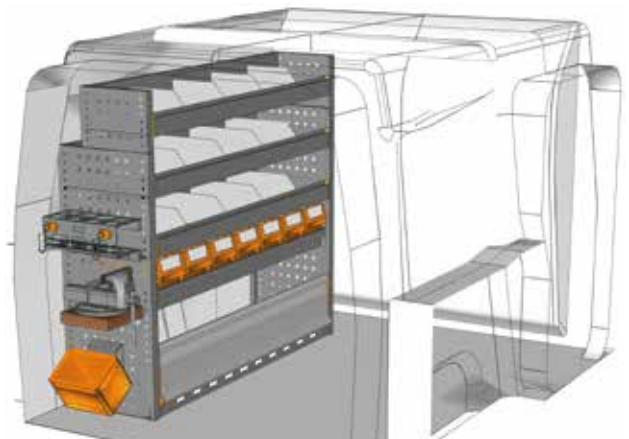
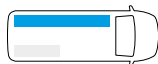

BEISPIEL - EXAMPLE

PA 1211 16*

B=1225 T=365 H=1100 mm - W=1225 D=365 H=1100 mm

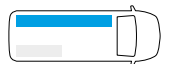

* Einschließlich Befestigungskit - Fixing kit included

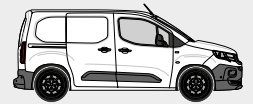

FAHRZEUGEINRICHTUNGSBEISPIELE - FITTINGS EXAMPLES

KASTENWAGEN - PANEL VAN
OPEL COMBO

SAFETY

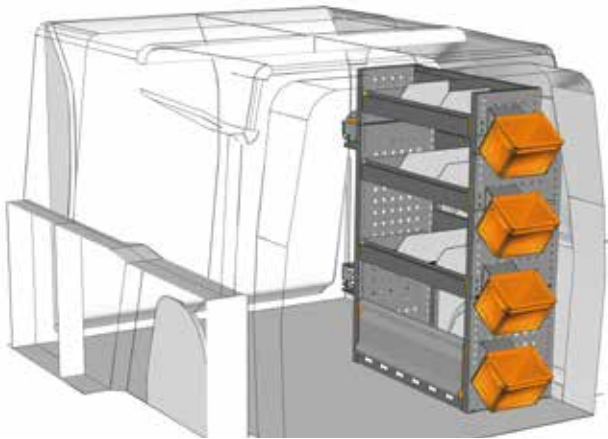

BEISPIEL - EXAMPLE

PA 0711 11*

B=717 T=365 H=1100 mm - W=717 D=365 H=1100 mm

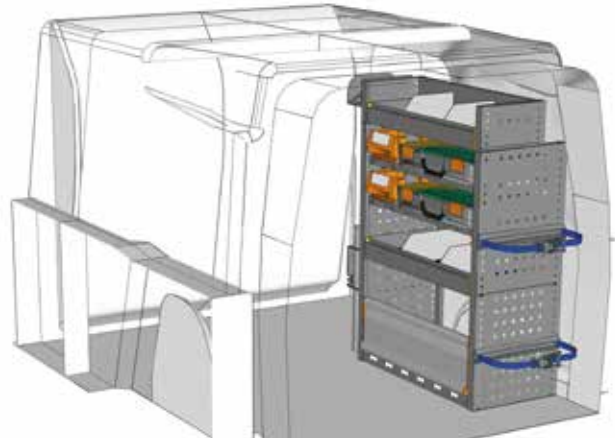

BEISPIEL - EXAMPLE

PA 0711 12*

B=717 T=365 H=1050 mm - W=717 D=365 H=1050 mm

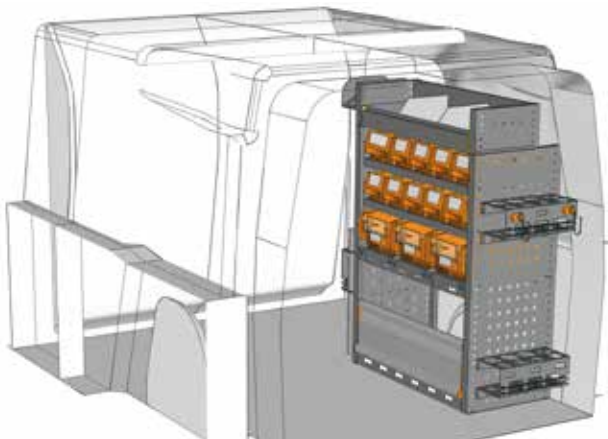
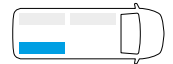

BEISPIEL - EXAMPLE

PA 0711 13*

B=717 T=365 H=1050 mm - W=717 D=365 H=1050 mm

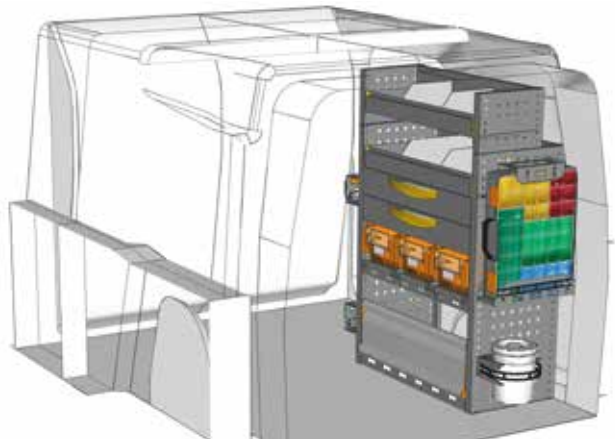

BEISPIEL - EXAMPLE

PA 0711 14*

B=717 T=365 H=1100 mm - W=717 D=365 H=1100 mm

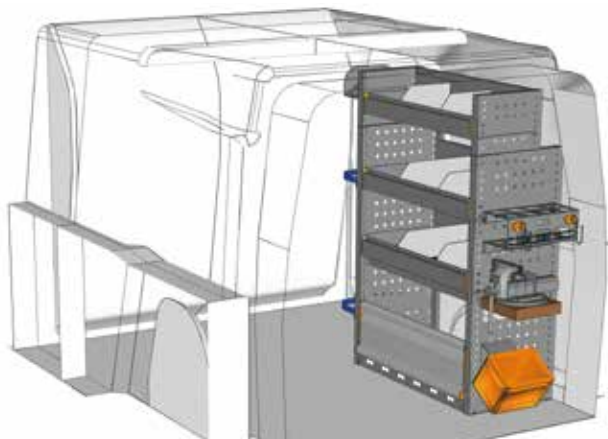
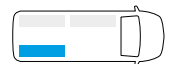

BEISPIEL - EXAMPLE

PA 0711 15*

B=717 T=365 H=1100 mm - W=717 D=365 H=1100 mm

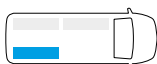

Haben Sie Ihre Einrichtung nicht gefunden?
Verlassen Sie sich auf die Profis für Fahrzeugeinrichtungen.
Auf der Rückseite dieses Katalogs finden Sie die nächstgelegene StoreVan Niederlassung. Besuchen Sie unsere Web-Seite.

Didn't find the equipment you're looking for?
Leave it to our experts.
See the back of this catalogue and contact the nearest StoreVan point or visit our website.



* Einschließlich Befestigungskit - Fixing kit included

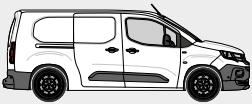

L2 H1

OPEL COMBO
KASTENWAGEN - PANEL VAN

SAFETY

FAHRZEUGEINRICHTUNGSBEISPIELE - FITTINGS EXAMPLES

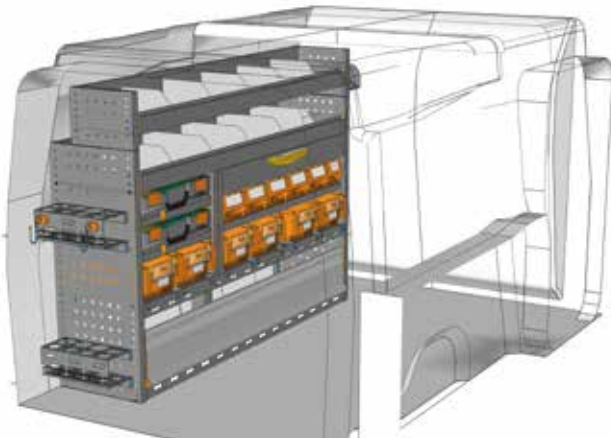

BEISPIEL - EXAMPLE

PA 1511 01*

B=1524 T=365 H=1100 mm - W=1524 D=365 H=1100 mm

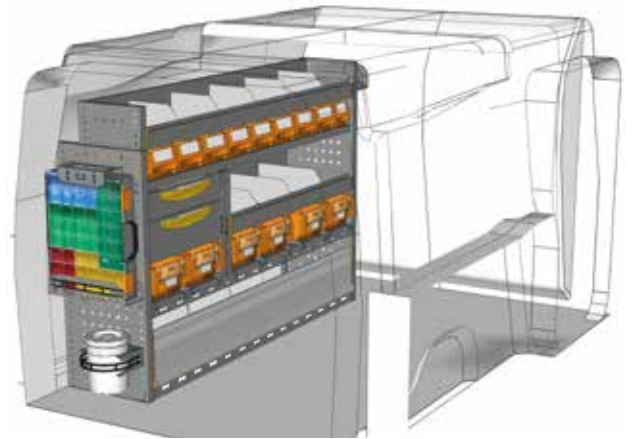
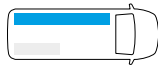

BEISPIEL - EXAMPLE

PA 1511 02*

B=1524 T=365 H=1050 mm - W=1524 D=365 H=1050 mm

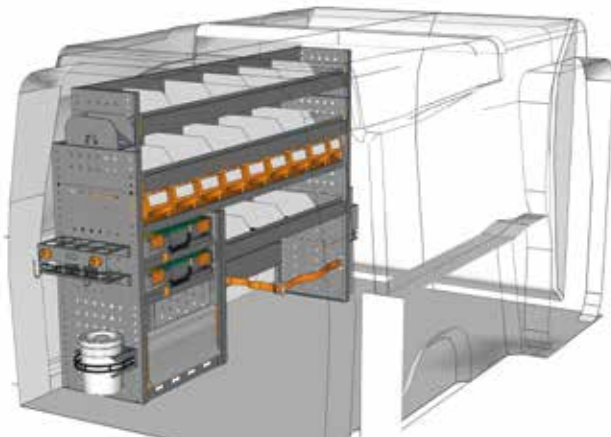

BEISPIEL - EXAMPLE

PA 1511 03*

B=1524 T=365 H=1100 mm - W=1524 D=365 H=1100 mm

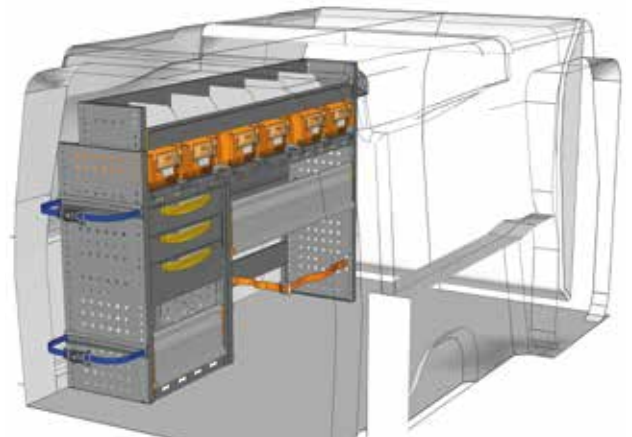

BEISPIEL - EXAMPLE

PA 1511 04*

B=1524 T=365 H=1050 mm - W=1524 D=365 H=1050 mm

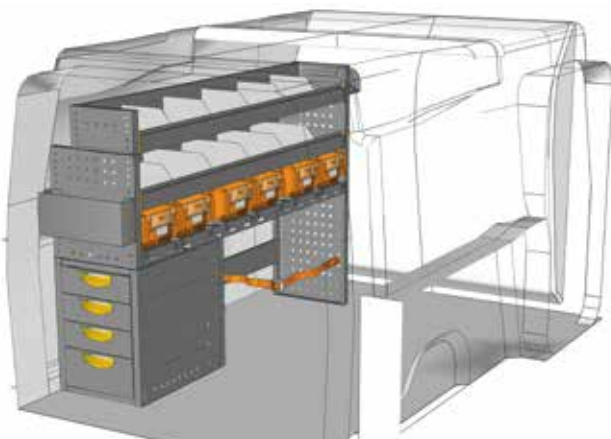

BEISPIEL - EXAMPLE

PA 1511 05*

B=1524 T=365 H=1050 mm - W=1524 D=365 H=1050 mm

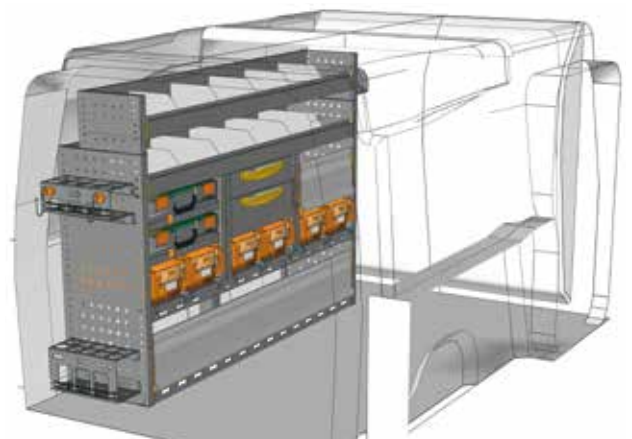

BEISPIEL - EXAMPLE

PA 1511 06*

B=1524 T=365 H=1100 mm - W=1524 D=365 H=1100 mm

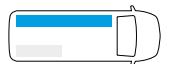

* Einschließlich Befestigungskit - Fixing kit included

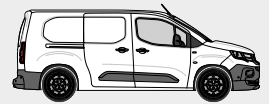

FAHRZEUGEINRICHTUNGSBEISPIELE - FITTINGS EXAMPLES

KASTENWAGEN - PANEL VAN
OPEL COMBO

SAFETY

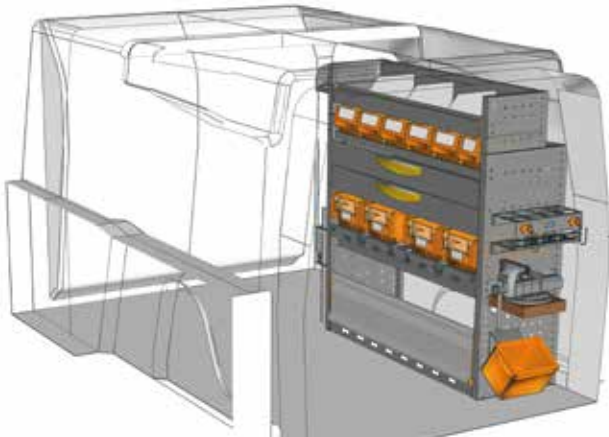

BEISPIEL - EXAMPLE

PA 1011 01*

B=1016 T=365 H=1100 mm - W=1016 D=365 H=1100 mm

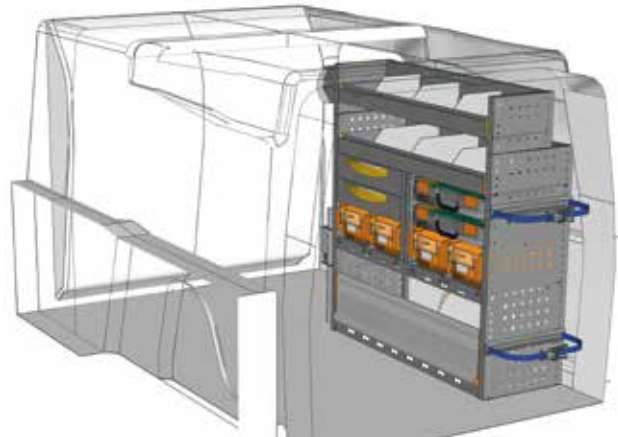

BEISPIEL - EXAMPLE

PA 1011 02*

B=1016 T=365 H=1100 mm - W=1016 D=365 H=1100 mm

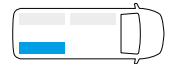

Ansicht von der Schiebetür
View from side door

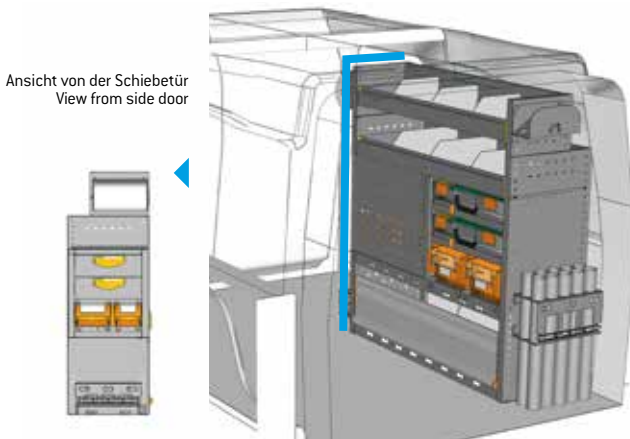

BEISPIEL - EXAMPLE

PA 1011 03*

B=1016 T=365 H=1100 mm - W=1016 D=365 H=1100 mm

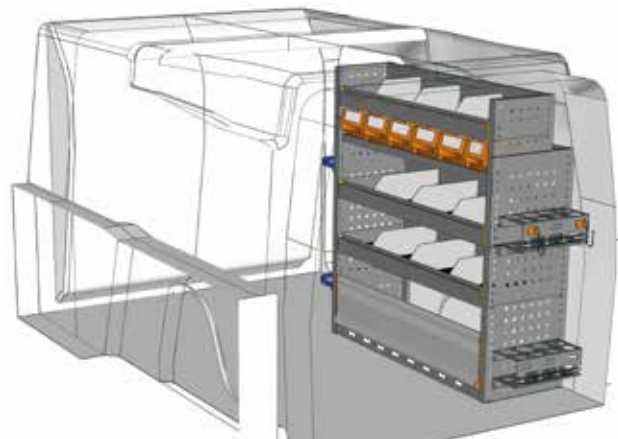
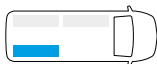

BEISPIEL - EXAMPLE

PA 1011 04*

B=1016 T=365 H=1100 mm - W=1016 D=365 H=1100 mm

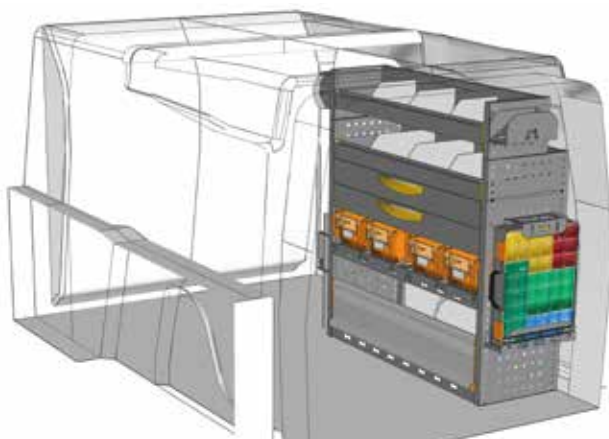
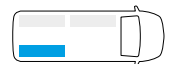

BEISPIEL - EXAMPLE

PA 1011 05*

B=1016 T=365 H=1100 mm - W=1016 D=365 H=1100 mm

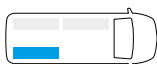

Haben Sie Ihre Einrichtung nicht gefunden?
Verlassen Sie sich auf die Profis für Fahrzeugeinrichtungen.
Auf der Rückseite dieses Katalogs finden Sie die nächstgelegene StoreVan Niederlassung. Besuchen Sie unsere Web-Seite.

Didn't find the equipment you're looking for?
Leave it to our experts.
See the back of this catalogue and contact the nearest StoreVan point or visit our website.



* Einschließlich Befestigungskit - Fixing kit included

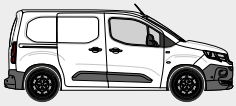

**Die perfekte Integration
zwischen Fahrzeug und mobiler
Werkstatteinrichtung**

Perfect integration between
vehicle and mobile workshop
equipment



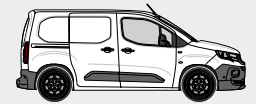

Die Transportereinrichtung **PROFESSIONAL** von Store Van ist perfekt im Fahrzeug integriert und eigens so entwickelt, dass sie die strukturellen und dynamischen Eigenschaften des Fahrzeugs hervorhebt. In den Modulen dieses neuen **Einrichtungsniveaus für Nutzfahrzeug**, z.B. in den Regalen für Transporter, sind für eine perfekte Befestigung der Ladung am Fahrzeugrahmen serienmäßig Elemente eingebaut, die „Airline“ Festhaltesysteme nutzen. Dank der neuen Bodenplatte **SAFETY FLOOR** stehen für die Ladungen vertikale und horizontale Festhaltesysteme zur Verfügung.

The Store Van **PROFESSIONAL equipment solution** is perfectly integrated in your vehicle and has been designed to enhance its structural and dynamic characteristics. The modules of this new **equipment for commercial vehicles**, such as shelving units for vans, are factory fitted with elements ensuring a perfect load anchoring to the chassis of your vehicle with “Airline” anchoring systems.

Both vertical and horizontal load restraining elements can be installed in your van thanks to the new **SAFETY FLOOR** panel.



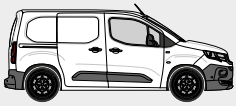

L1 H1

OPEL COMBO
KASTENWAGEN - PANEL VAN

PROFESSIONAL

FAHRZEUGEINRICHTUNGSBEISPIELE - FITTINGS EXAMPLES

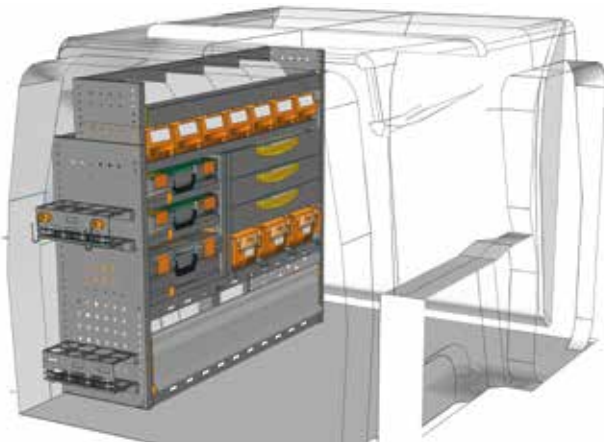

BEISPIEL - EXAMPLE

PA 1211 P1*

B=1225 T=365 H=1100 mm - W=1225 D=365 H=1100 mm

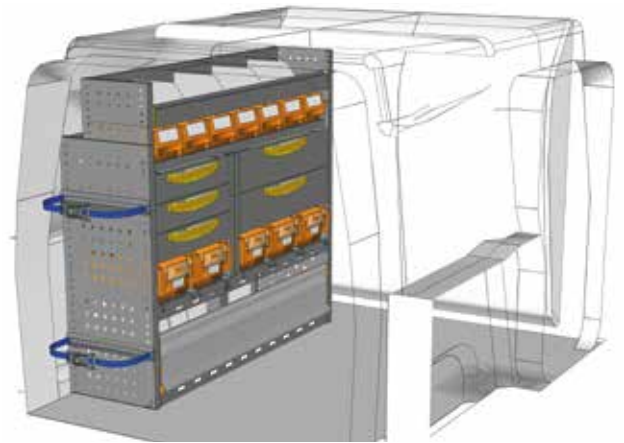
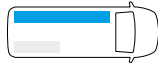

BEISPIEL - EXAMPLE

PA 1211 P2*

B=1225 T=365 H=1100 mm - W=1225 D=365 H=1100 mm

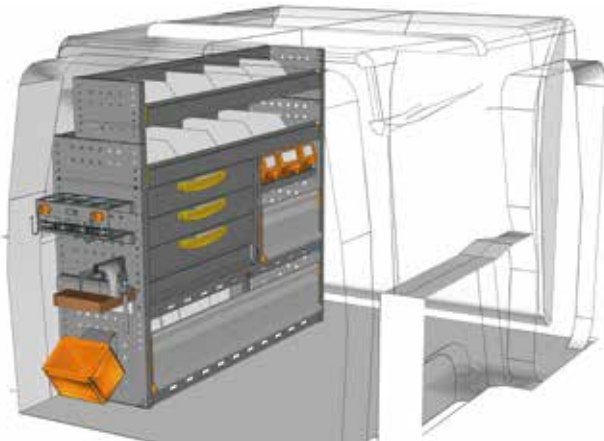

BEISPIEL - EXAMPLE

PA 1211 P3*

B=1225 T=365 H=1100 mm - W=1225 D=365 H=1100 mm

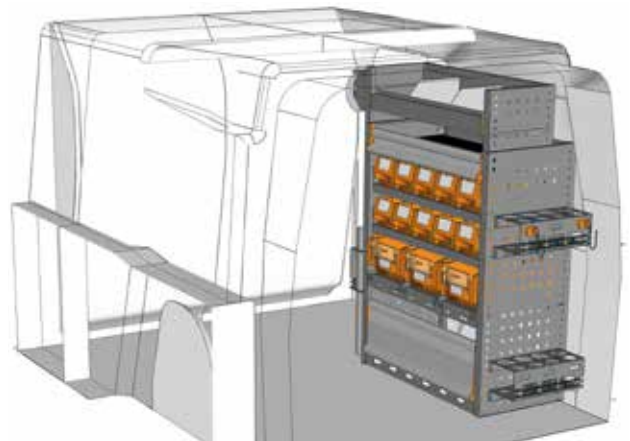
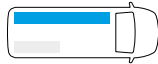

BEISPIEL - EXAMPLE

PA 0711 P1*

B=717 T=365 H=1100 mm - W=717 D=365 H=1100 mm

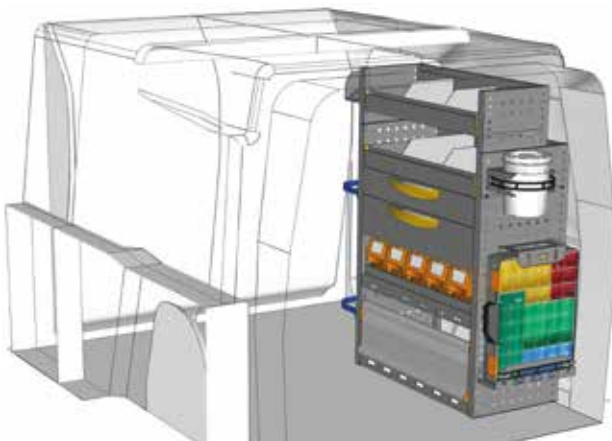
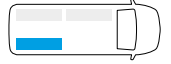

BEISPIEL - EXAMPLE

PA 0711 P2*

B=717 T=365 H=1100 mm - W=717 D=365 H=1100 mm

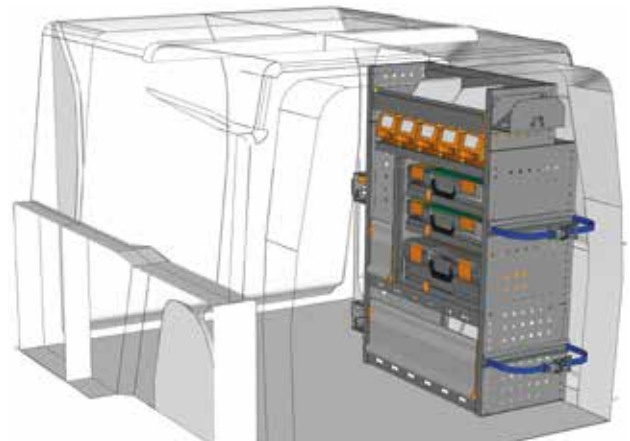
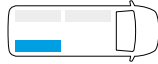

BEISPIEL - EXAMPLE

PA 0711 P3*

B=717 T=365 H=1100 mm - W=717 D=365 H=1100 mm



* Einschließlich Befestigungskit - Fixing kit included

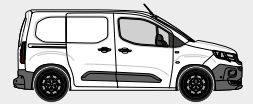

FAHRZEUGEINRICHTUNGSBEISPIELE - FITTINGS EXAMPLES

KASTENWAGEN - PANEL VAN
OPEL COMBO

PROFESSIONAL

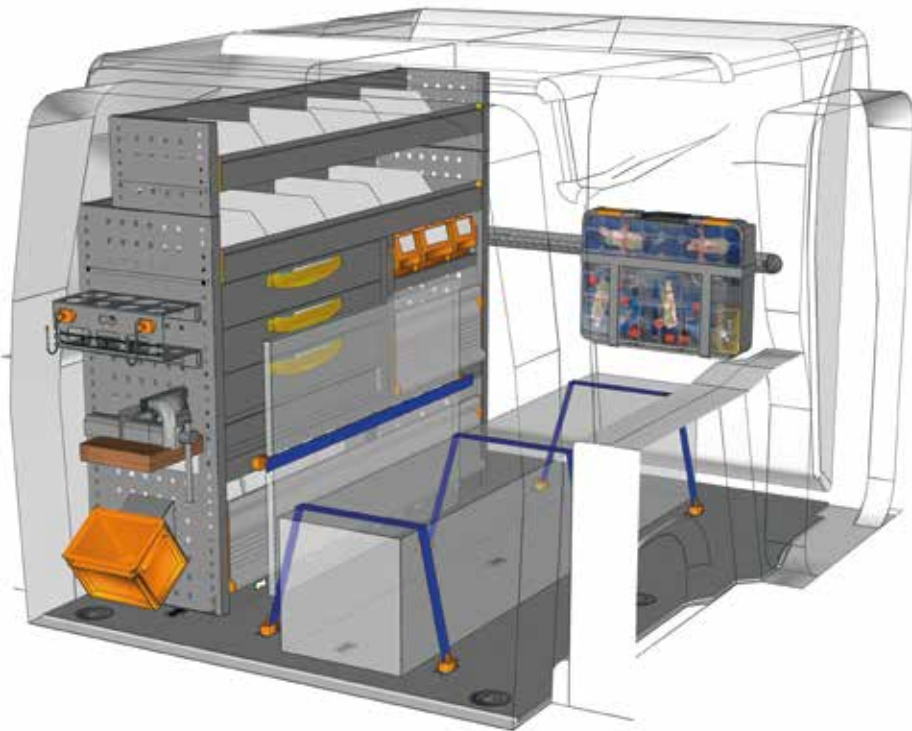

BEISPIEL - EXAMPLE

EXAMPLE PA L1H1 P1*



- | | |
|----------------|-------------|
| 1 x PA 1211 P3 | 2 x V22124 |
| 1 x PA 10K1 B1 | 2 x V22148 |
| 1 x V22585 | 1 x YELLOW |
| 1 x V18029 10 | 4 x V225820 |
| 2 x V22106 | |
| 1 x BOX080 | |
| 1 x CPV080 | |
| 2 x V22136 | |

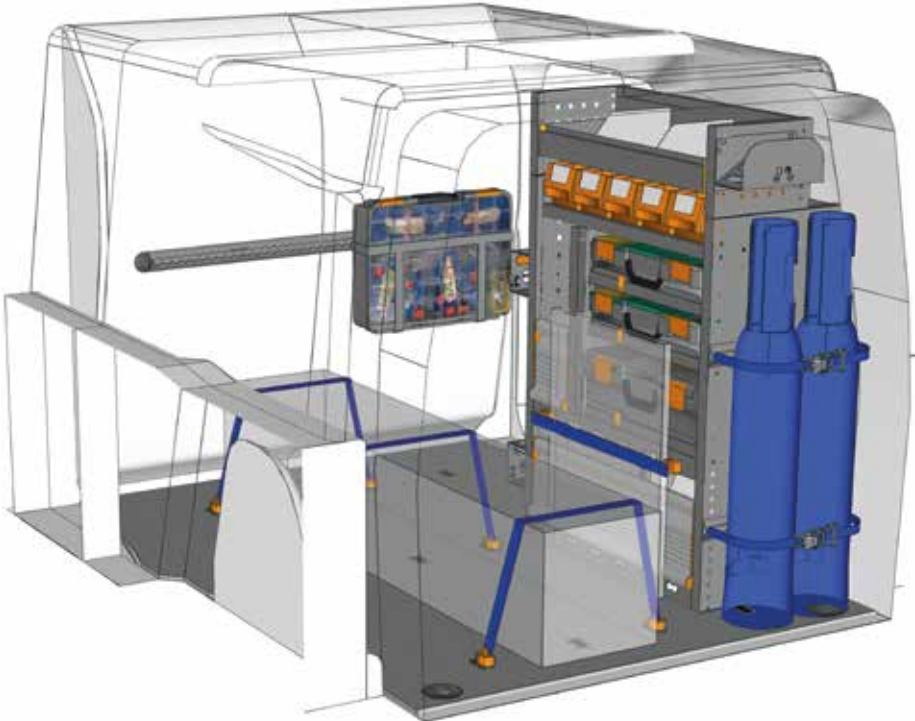

BEISPIEL - EXAMPLE

EXAMPLE PA L1H1 P2*



- | | |
|----------------|-------------|
| 1 x PA 0711 P3 | 2 x V22124 |
| 1 x PA 10K1 B1 | 2 x V22148 |
| 1 x V22585 | 1 x YELLOW |
| 1 x V18029 10 | 4 x V225820 |
| 2 x V22106 | |
| 1 x BOX080 | |
| 1 x CPV080 | |
| 2 x V22136 | |

**Haben Sie Ihre Einrichtung nicht gefunden?
Verlassen Sie sich auf die Profis für
Fahrzeugeinrichtungen.**

Auf der Rückseite dieses Katalogs
finden Sie die nächstgelegene
StoreVan Niederlassung.
Besuchen Sie unsere Web-Seite.

**Didn't find the equipment
you're looking for?
Leave it to our experts.**

See the back of this catalogue
and contact the nearest
StoreVan point or visit our website.

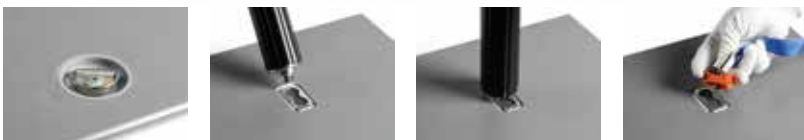

siehe Seiten 10/11
see pages 10/11

* Einschließlich Befestigungskit - Fixing kit included

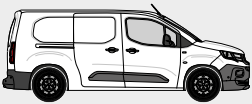

L2 H1

OPEL COMBO
KASTENWAGEN - PANEL VAN

PROFESSIONAL

FAHRZEUGEINRICHTUNGSBEISPIELE - FITTINGS EXAMPLES

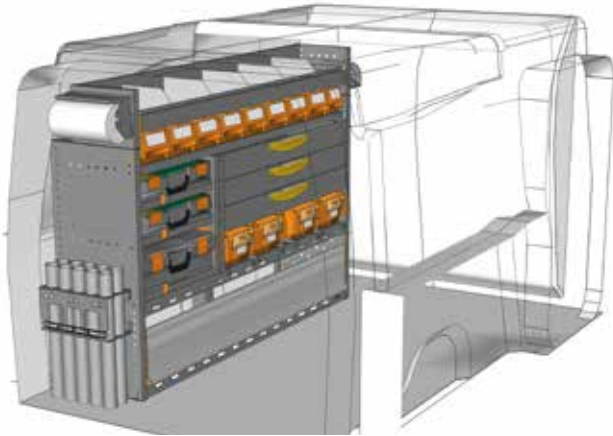

BEISPIEL - EXAMPLE

PA 1511 P1*

B=1524 T=365 H=1100 mm - W=1524 D=365 H=1100 mm

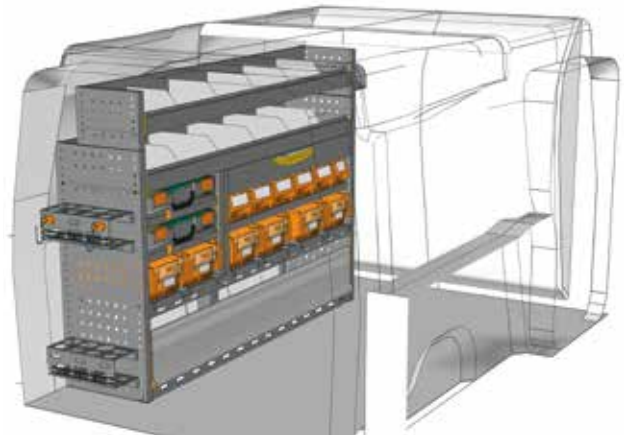
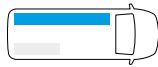

BEISPIEL - EXAMPLE

PA 1511 P2*

B=1524 T=365 H=1100 mm - W=1524 D=365 H=1100 mm

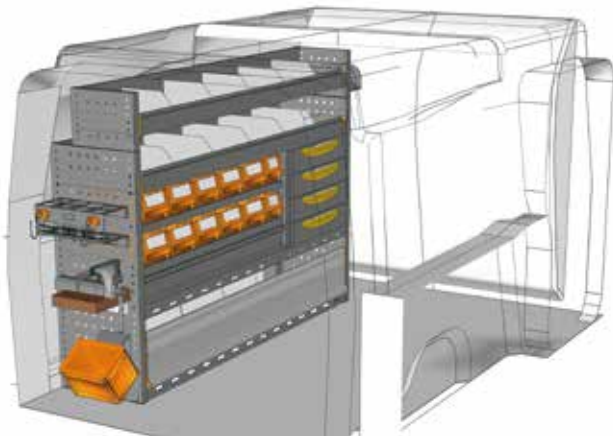

BEISPIEL - EXAMPLE

PA 1511 P3*

B=1524 T=365 H=1100 mm - W=1524 D=365 H=1100 mm

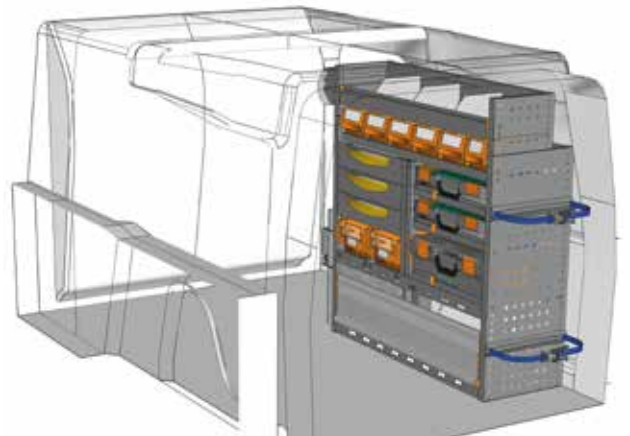
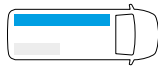

BEISPIEL - EXAMPLE

PA 1011 P1*

B=1016 T=365 H=1100 mm - W=1016 D=365 H=1100 mm

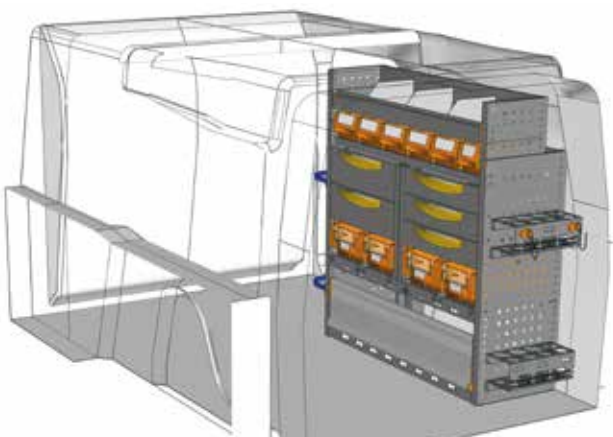
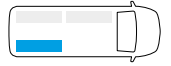

BEISPIEL - EXAMPLE

PA 1011 P2*

B=1016 T=365 H=1100 mm - W=1016 D=365 H=1100 mm

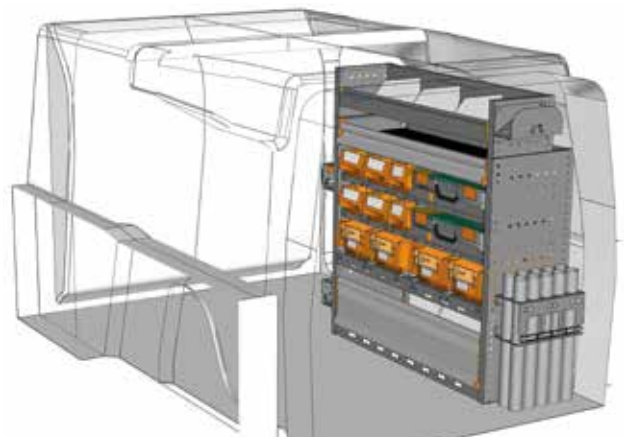
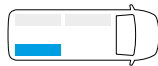

BEISPIEL - EXAMPLE

PA 1011 P3*

B=1016 T=365 H=1100 mm - W=1016 D=365 H=1100 mm

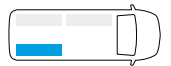

* Einschließlich Befestigungskit - Fixing kit included

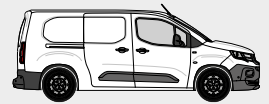

FAHRZEUGEINRICHTUNGSBEISPIELE - FITTINGS EXAMPLES

KASTENWAGEN - PANEL VAN
OPEL COMBO

PROFESSIONAL

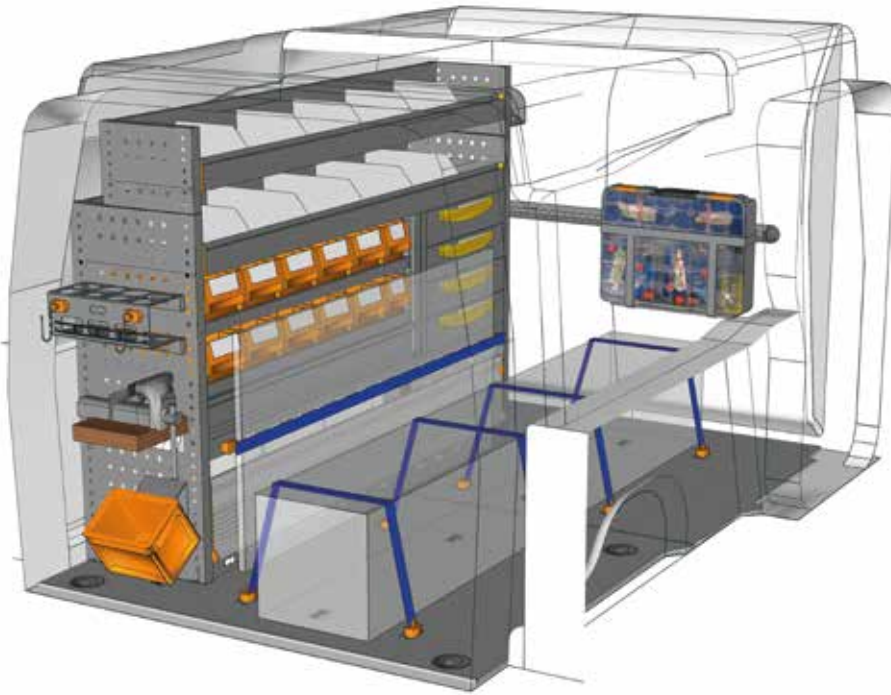

BEISPIEL - EXAMPLE

EXAMPLE PA L2H1 P1*



- | | |
|----------------|-------------|
| 1 x PA 1511 P3 | 2 x V22124 |
| 1 x PA 20K1 B1 | 2 x V22148 |
| 1 x V22585 | 1 x YELLOW |
| 1 x V18029 10 | 4 x V225820 |
| 2 x V22106 | |
| 1 x BOX080 | |
| 1 x CPV080 | |
| 2 x V22136 | |

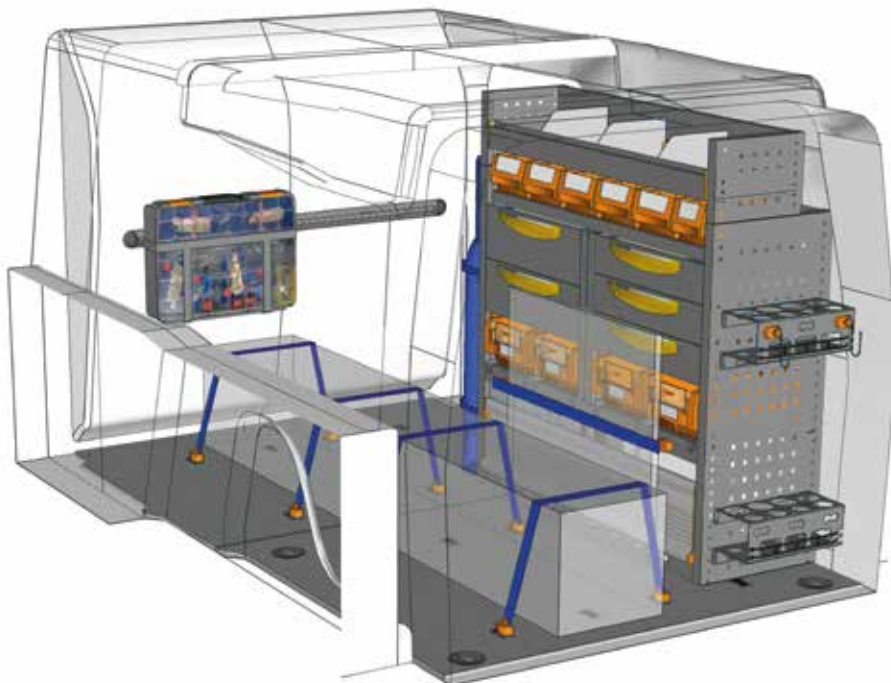

BEISPIEL - EXAMPLE

EXAMPLE PA L2H1 P2*



- | | |
|----------------|-------------|
| 1 x PA 1011 P2 | 2 x V22124 |
| 1 x PA 20K1 B1 | 2 x V22148 |
| 1 x V22585 | 1 x YELLOW |
| 1 x V18029 10 | 4 x V225820 |
| 2 x V22106 | |
| 1 x BOX080 | |
| 1 x CPV080 | |
| 2 x V22136 | |

**Haben Sie Ihre Einrichtung nicht gefunden?
Verlassen Sie sich auf die Profis für
Fahrzeugeinrichtungen.**

Auf der Rückseite dieses Katalogs
finden Sie die nächstgelegene
StoreVan Niederlassung.
Besuchen Sie unsere Web-Seite.

**Didn't find the equipment
you're looking for?
Leave it to our experts.**

See the back of this catalogue
and contact the nearest
StoreVan point or visit our website.

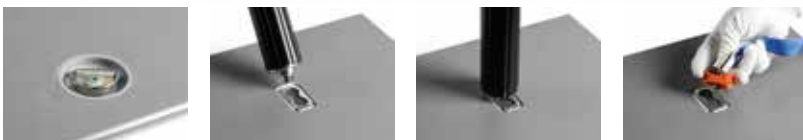

siehe Seiten 10/11
see pages 10/11

* Einschließlich Befestigungskit - Fixing kit included



**Nicht nur Fahrzeug,
sondern auch Mobilität**

All-out mobility

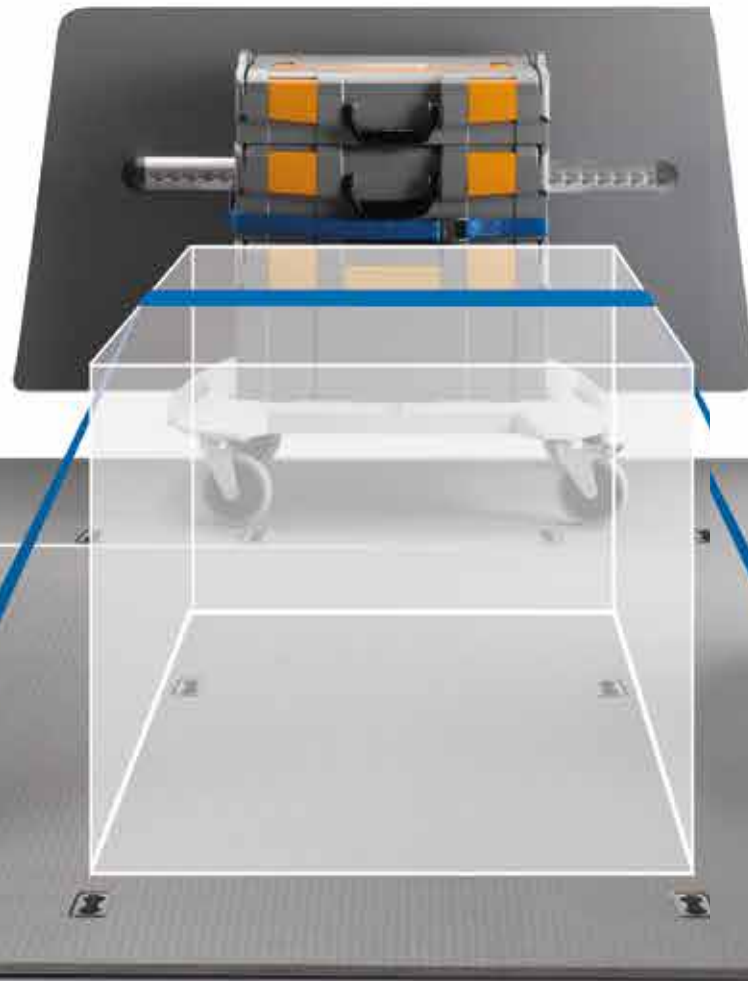

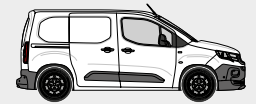

Die Lösung MOBILE ergänzt die Store Van Nutzfahrzeugeinrichtungen mit den Kleinteilekoffern der Serie STORE BOX 102 – 136 – 238 und dem dazugehörigen Wagen, der den Benutzer der **mobilen Werkstatt** beim Transport der Waren und Ausrüstung vom Fahrzeug zur Arbeitsstelle unterstützt. Die neuen „Airline“ Verankerungselemente erhöhen die Stabilität des Moduls, ohne sein Gewicht zu beeinflussen. Auch in diesem Fall werden in den Regalen Elemente eingebaut, die eine Nutzung der „Airline“ Festhaltesysteme ermöglichen. Auch dank der Einführung der Bodenplatte SAFETY FLOOR können sowohl vertikale als auch horizontale Ladungssicherungssysteme gewählt werden.

The **MOBILE equipment solution** integrates Store Van fittings for commercial vehicles with small-parts cases, series STORE BOX 102 – 136 – 238, and trolleys by which **mobile workshop** users can easily carry their goods and tools from their van to the workplace.

The new “Airline” anchoring fittings improve the stability of modules with no weight increase. Here shelving units are integrated with elements where “Airline” anchoring systems can easily fit. Both vertical and horizontal load restraining elements can be installed in your van thanks to the new SAFETY FLOOR flooring panels.



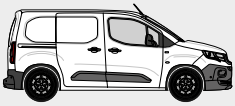

L1 H1

MOBILE
KASTENWAGEN - PANEL VAN

MOBILE

FAHRZEUGEINRICHTUNGSBEISPIELE - FITTINGS EXAMPLES

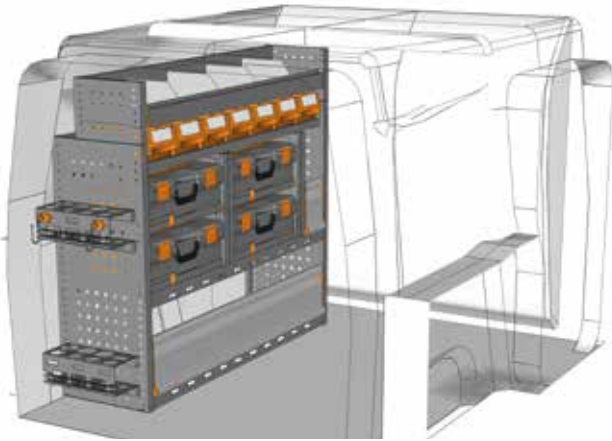

BEISPIEL - EXAMPLE

PA 1211 M1*

B=1225 T=365 H=1100 mm - W=1225 D=365 H=1100 mm

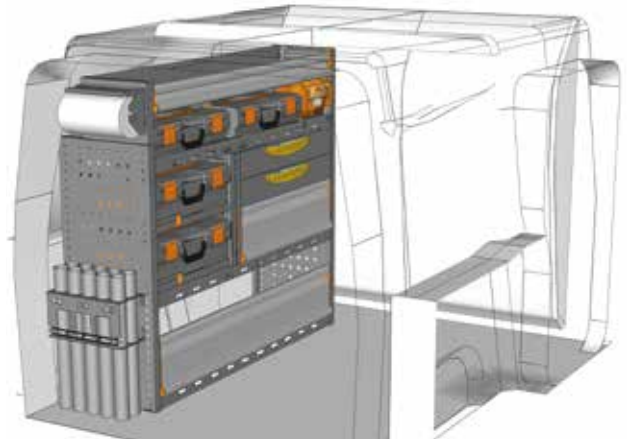
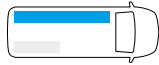

BEISPIEL - EXAMPLE

PA 1211 M2*

B=1225 T=365 H=1100 mm - W=1225 D=365 H=1100 mm

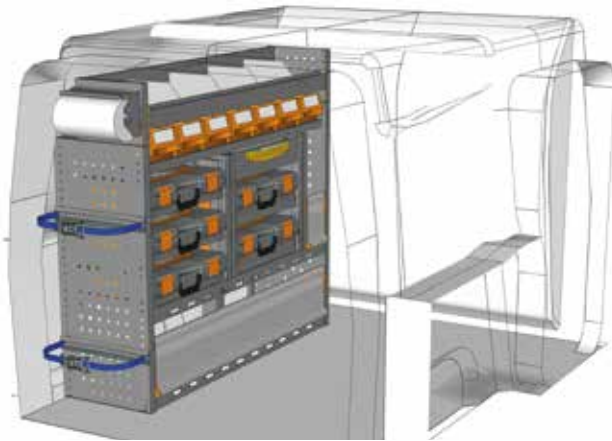

BEISPIEL - EXAMPLE

PA 1211 M3*

B=1225 T=365 H=1100 mm - W=1225 D=365 H=1100 mm

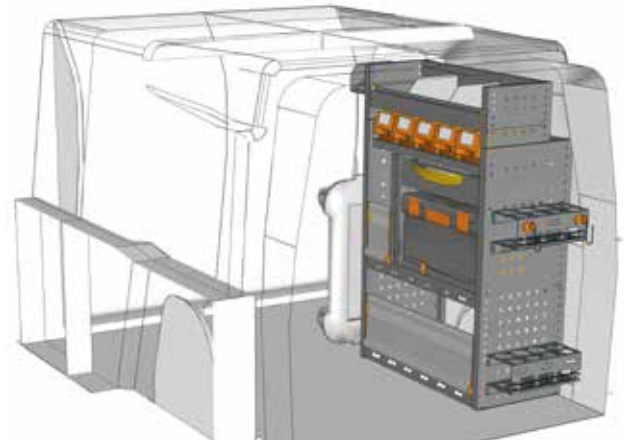
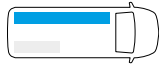

BEISPIEL - EXAMPLE

PA 0711 M1*

B=717 T=365 H=1100 mm - W=717 D=365 H=1100 mm

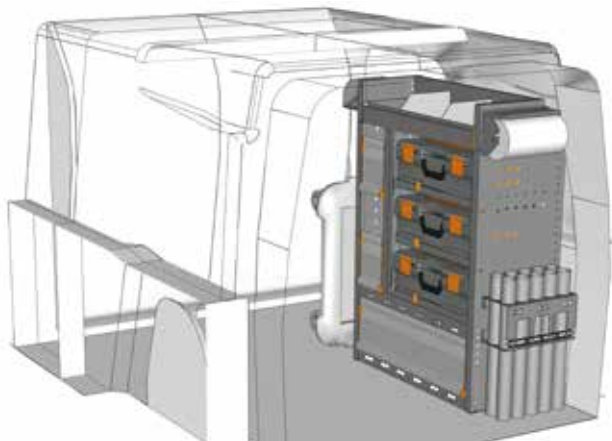
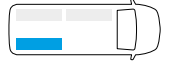

BEISPIEL - EXAMPLE

PA 0711 M2*

B=717 T=365 H=1050 mm - W=717 D=365 H=1050 mm

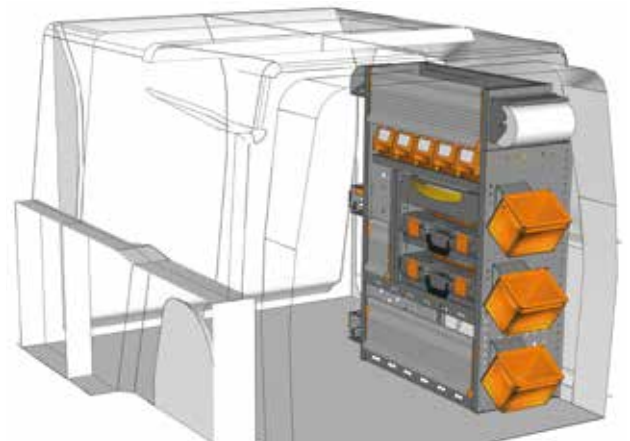
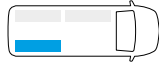

BEISPIEL - EXAMPLE

PA 0711 M3*

B=717 T=365 H=1100 mm - W=717 D=365 H=1100 mm

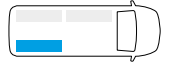

* Einschließlich Befestigungskit - Fixing kit included

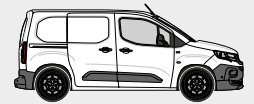

FAHRZEUGEINRICHTUNGSBEISPIELE - FITTINGS EXAMPLES

KASTENWAGEN - PANEL VAN
OPEL COMBO

MOBILE

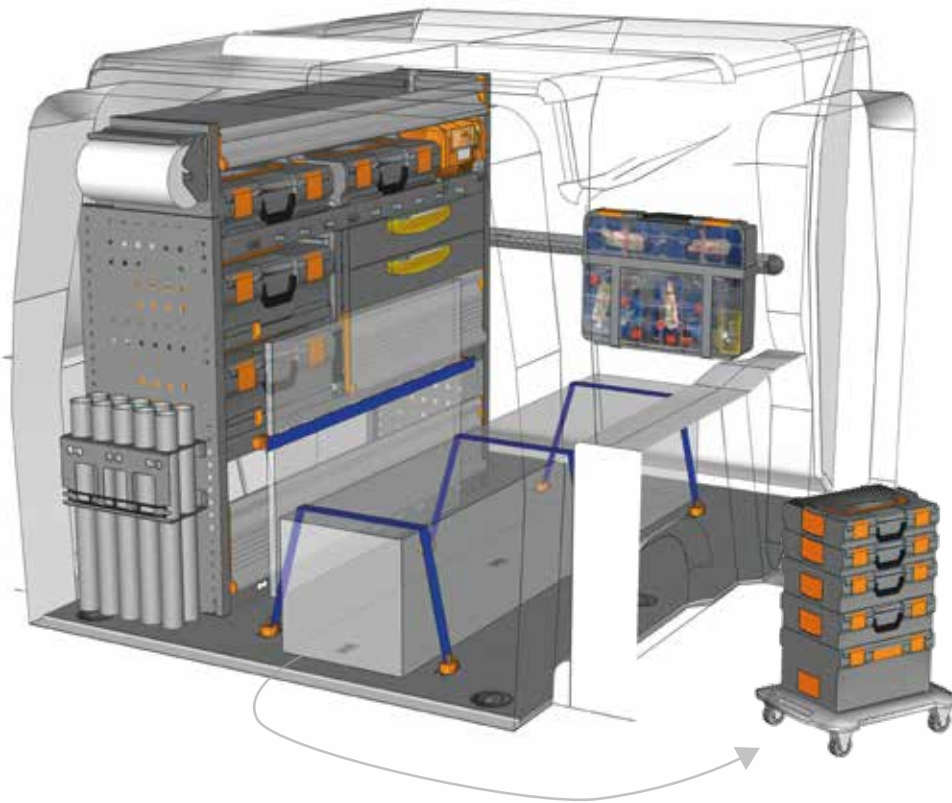

BEISPIEL - EXAMPLE

EXAMPLE PA L1H1 M1*



- | | |
|----------------|-------------|
| 1 x PA 1211 M2 | 2 x V22124 |
| 1 x PA 10K1 B1 | 2 x V22148 |
| 1 x V22585 | 1 x YELLOW |
| 1 x V18029 10 | 4 x V225820 |
| 2 x V22106 | |
| 1 x BOX080 | |
| 1 x CPV080 | |
| 2 x V22136 | |

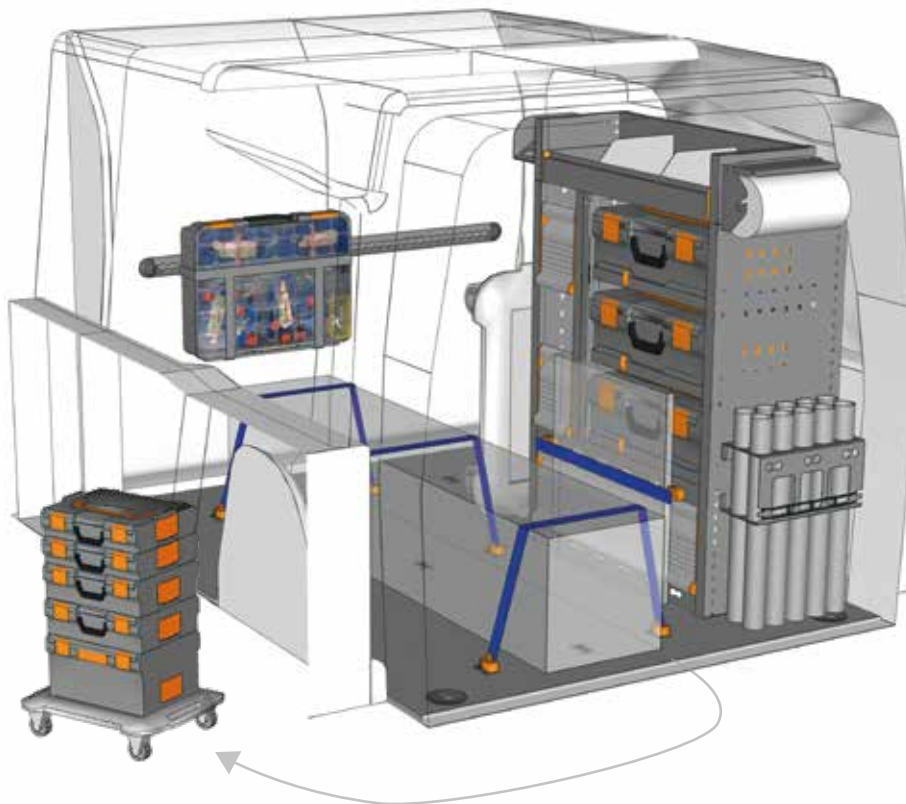

BEISPIEL - EXAMPLE

EXAMPLE PA L1H1 M2*



- | | |
|----------------|-------------|
| 1 x PA 0711 M2 | 2 x V22124 |
| 1 x PA 10K1 B1 | 2 x V22148 |
| 1 x V22585 | 1 x YELLOW |
| 1 x V18029 10 | 4 x V225820 |
| 2 x V22106 | |
| 1 x BOX080 | |
| 1 x CPV080 | |
| 2 x V22136 | |

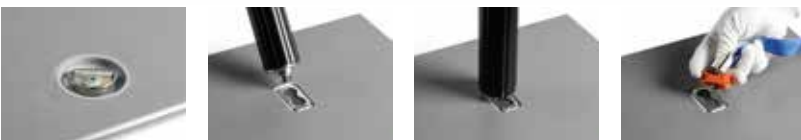

siehe Seiten 10/11
see pages 10/11

* Einschließlich Befestigungskit - Fixing kit included

Haben Sie Ihre Einrichtung nicht gefunden?
Verlassen Sie sich auf die Profis für Fahrzeugeinrichtungen.
Auf der Rückseite dieses Katalogs finden Sie die nächstgelegene StoreVan Niederlassung. Besuchen Sie unsere Web-Seite.

Didn't find the equipment you're looking for?
Leave it to our experts.
See the back of this catalogue and contact the nearest StoreVan point or visit our website.



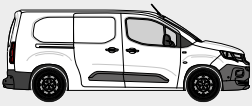

L2 H1

MOBILE
KASTENWAGEN - PANEL VAN

FAHRZEUGEINRICHTUNGSBEISPIELE - FITTINGS EXAMPLES

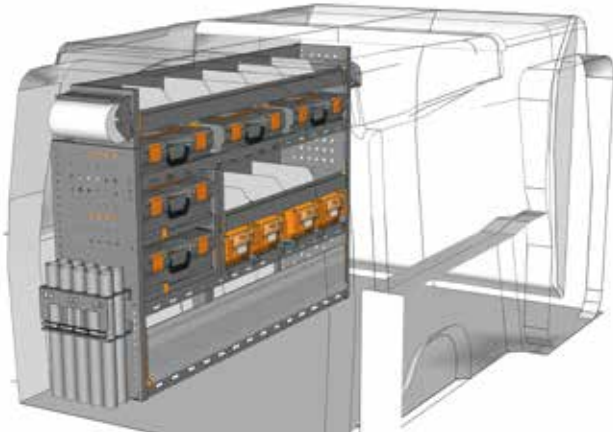

BEISPIEL - EXAMPLE

PA 1511 M1*

B=1524 T=365 H=1100 mm - W=1524 D=365 H=1100 mm

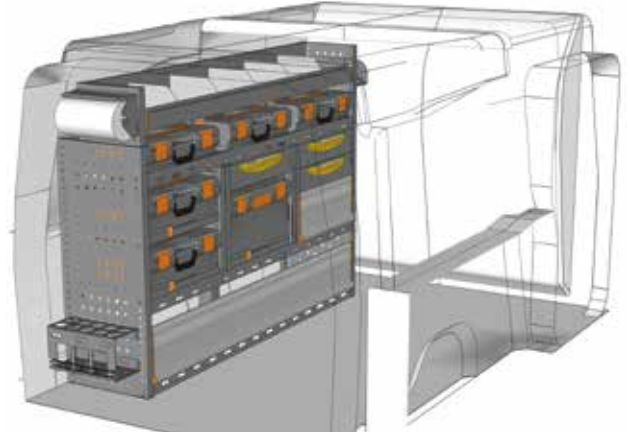
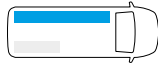

BEISPIEL - EXAMPLE

PA 1511 M2*

B=1524 T=365 H=1100 mm - W=1524 D=365 H=1100 mm

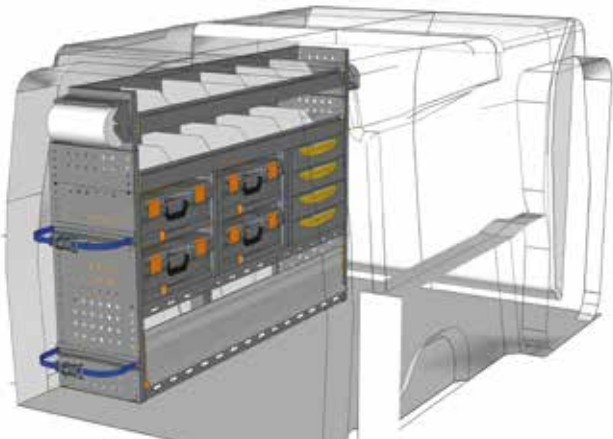

BEISPIEL - EXAMPLE

PA 1511 M3*

B=1524 T=365 H=1100 mm - W=1524 D=365 H=1100 mm

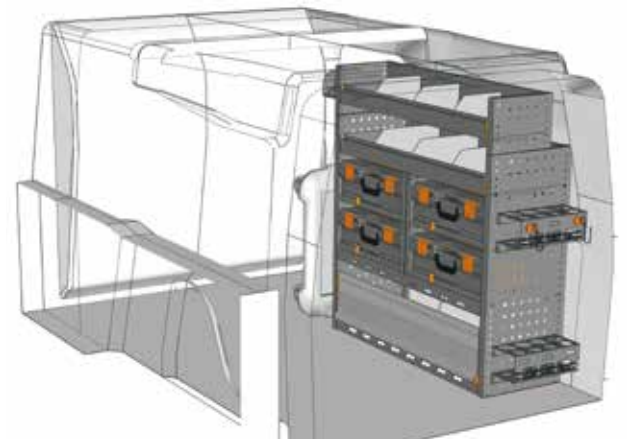
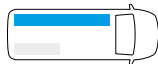

BEISPIEL - EXAMPLE

PA 1011 M1*

B=1016 T=365 H=1100 mm - W=1016 D=365 H=1100 mm

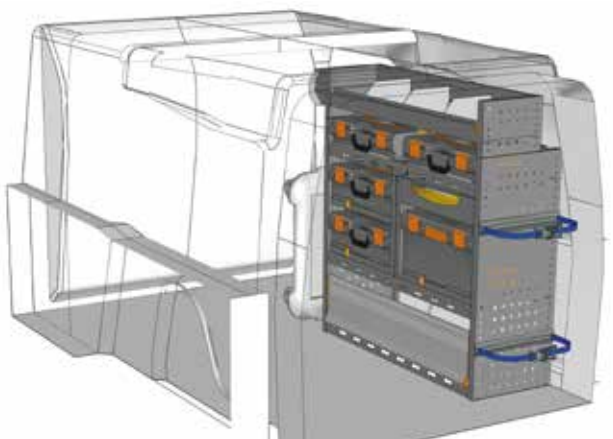
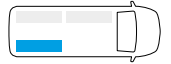

BEISPIEL - EXAMPLE

PA 1011 M2*

B=1016 T=365 H=1100 mm - W=1016 D=365 H=1100 mm

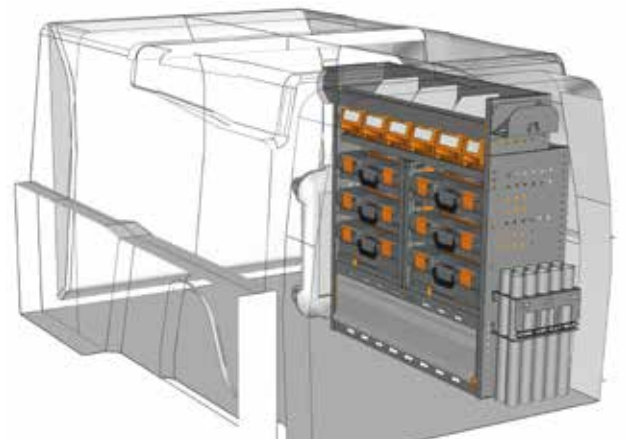
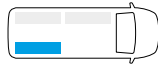

BEISPIEL - EXAMPLE

PA 1011 M3*

B=1016 T=365 H=1100 mm - W=1016 D=365 H=1100 mm

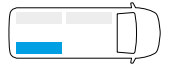

* Einschließlich Befestigungskit - Fixing kit included

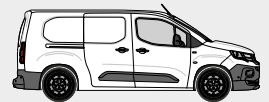

FAHRZEUGEINRICHTUNGSBEISPIELE - FITTINGS EXAMPLES

KASTENWAGEN - PANEL VAN
OPEL COMBO

MOBILE

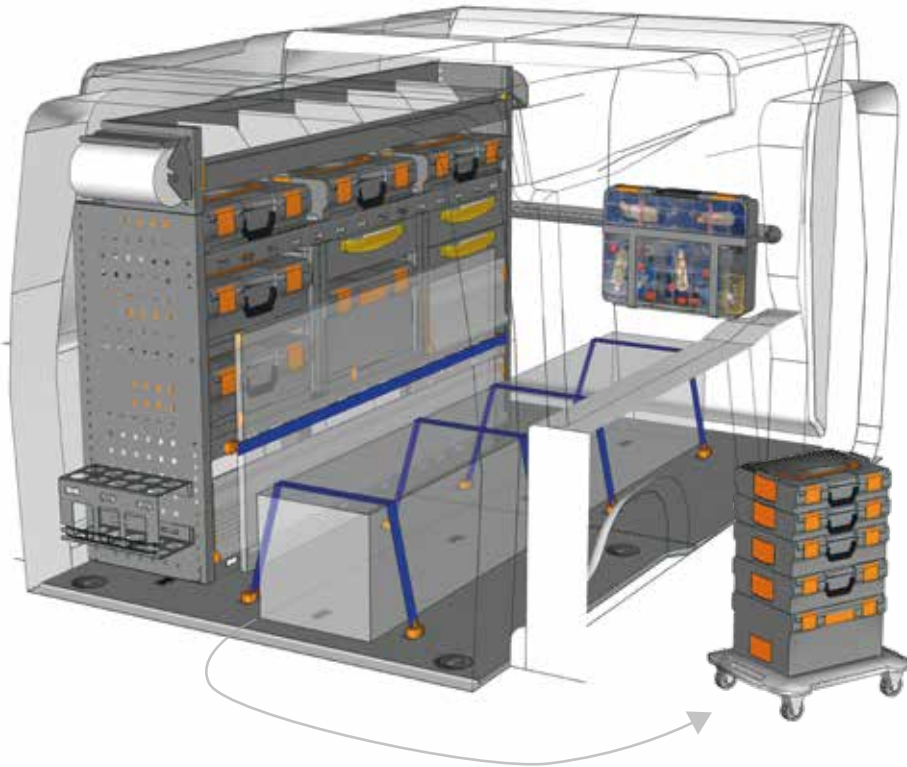

BEISPIEL - EXAMPLE

EXAMPLE PA L2H1 M1*



- | | |
|----------------|-------------|
| 1 x PA 1511 M2 | 2 x V22124 |
| 1 x PA 20K1 B1 | 2 x V22148 |
| 1 x V22585 | 1 x YELLOW |
| 1 x V18029 10 | 4 x V225820 |
| 2 x V22106 | |
| 1 x BOX080 | |
| 1 x CPV080 | |
| 2 x V22136 | |

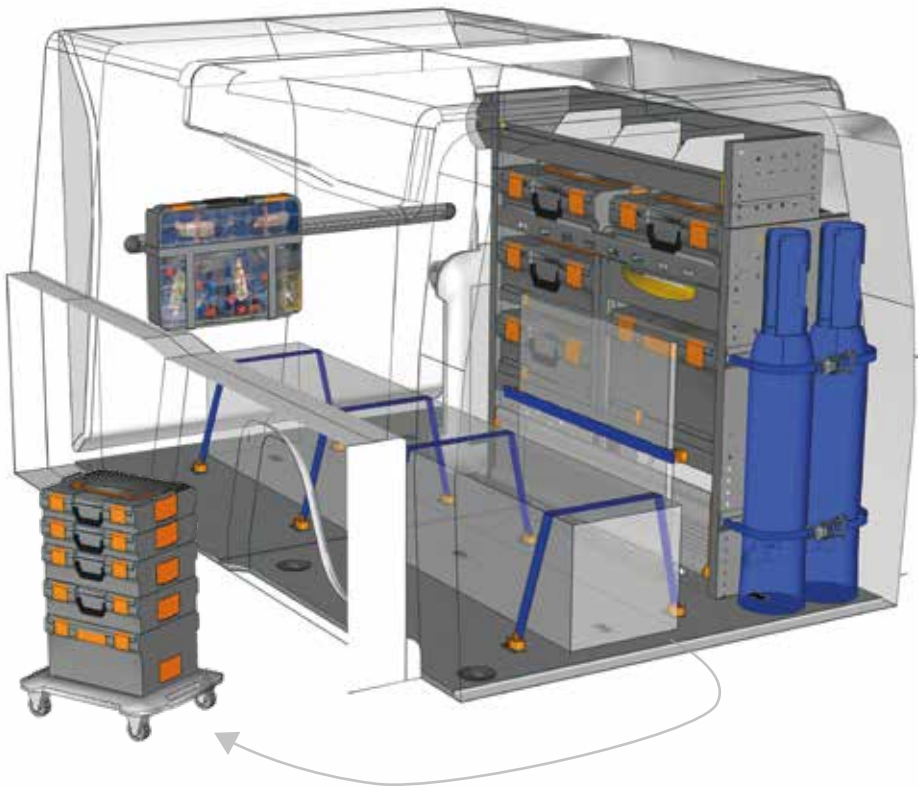

BEISPIEL - EXAMPLE

EXAMPLE PA L2H1 M2*



- | | |
|----------------|-------------|
| 1 x PA 1011 M2 | 2 x V22124 |
| 1 x PA 20K1 B1 | 2 x V22148 |
| 1 x V22585 | 1 x YELLOW |
| 1 x V18029 10 | 4 x V225820 |
| 2 x V22106 | |
| 1 x BOX080 | |
| 1 x CPV080 | |
| 2 x V22136 | |

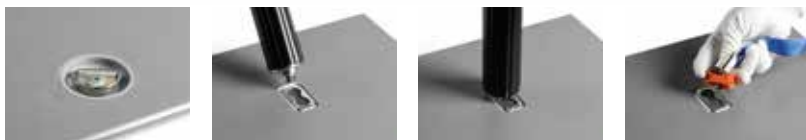

siehe Seiten 10/11
see pages 10/11

* Einschließlich Befestigungskit - Fixing kit included

Haben Sie Ihre Einrichtung nicht gefunden?
Verlassen Sie sich auf die Profis für Fahrzeugeinrichtungen.
Auf der Rückseite dieses Katalogs finden Sie die nächstgelegene StoreVan Niederlassung. Besuchen Sie unsere Web-Seite.

Didn't find the equipment you're looking for?
Leave it to our experts.
See the back of this catalogue and contact the nearest StoreVan point or visit our website.





Die ergonomische Einrichtung, die sichere Arbeitsbedingungen erleichtert.

Ergonomic equipment that makes work easier and safer

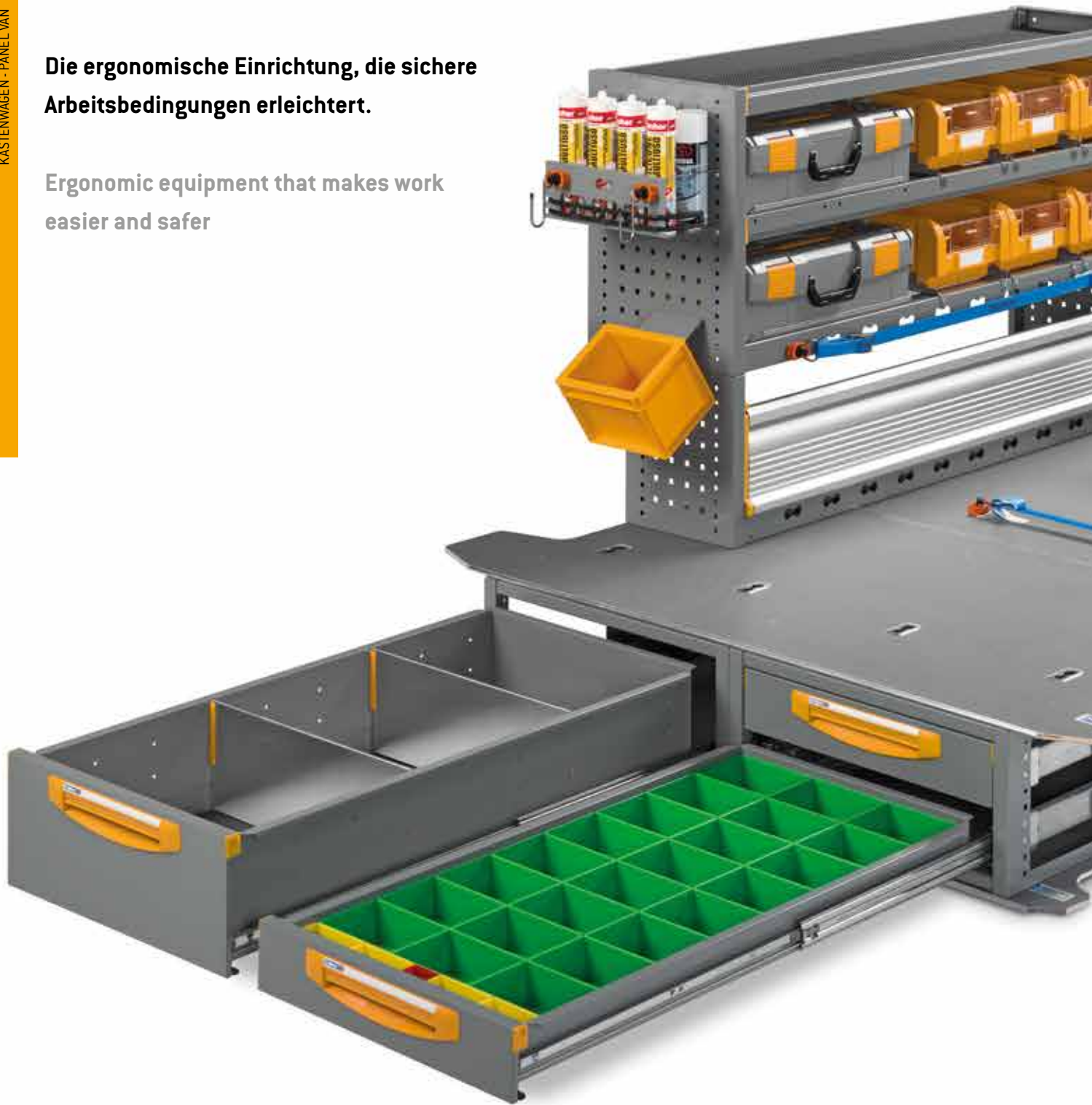

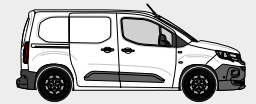

FLOOR UP ist die Transportereinrichtung von Store Van mit Doppelniveau, d.h. Schubladen unter der Bodenplatte, für eine **bessere Ladefähigkeit bei Nutzfahrzeugen mit weniger als 5 m³ Ladevolumen**. Die Lagerung und das Handling der Waren sind für eine verbesserte Ergonomie und einen einfachen und schnellen Transport konzipiert. Eine besondere Aufmerksamkeit wurde dabei der Verwendung und demzufolge der Notwendigkeit eines sicheren Transports von Werkzeugen, Elektrowerkzeugen und Ausrüstungen verschiedener Art gewidmet. Dieses Ergebnis wurde dank besonders langer Schubladen mit einem großzügigen Innenvolumen erzielt, die am hinteren und seitlichen Fahrzeugbereich, dort wo sich die Fahrzeugtüren befinden, unter der Bodenplatte eingesetzt werden. Die Seitenwände der Schubladen verhindern dank ihrer vollen Höhe, dass beim Transport Material

herausfallen kann.

Die Schubladen unter der Bodenplatte verbinden eine hohe Tragfähigkeit von **je 80 kg** mit einer umfangreichen Trennmaterialeauswahl, wie verschiebbare Einteiler aus Aluminium und Kunststoffboxen in verschiedenen Größen zum Aufteilen und Blockieren der enthaltenen Materialien.

Oberhalb der Ausstattung wurde eine 9-schichtige Bodenplatte aus Bootsbaubirnenholz mit einer hochresistenten Spezialverkleidung und einem vom TÜV zertifizierten Reibwert eingesetzt. Serienmäßig werden **12 zusätzliche AIRLINE-Verankerungen** mit einer Zugkraft von 200 daN geliefert, wie von der neuen europäischen Richtlinie 2014/47/EU für Sicherheit und Ladungssicherung vorgeschrieben.

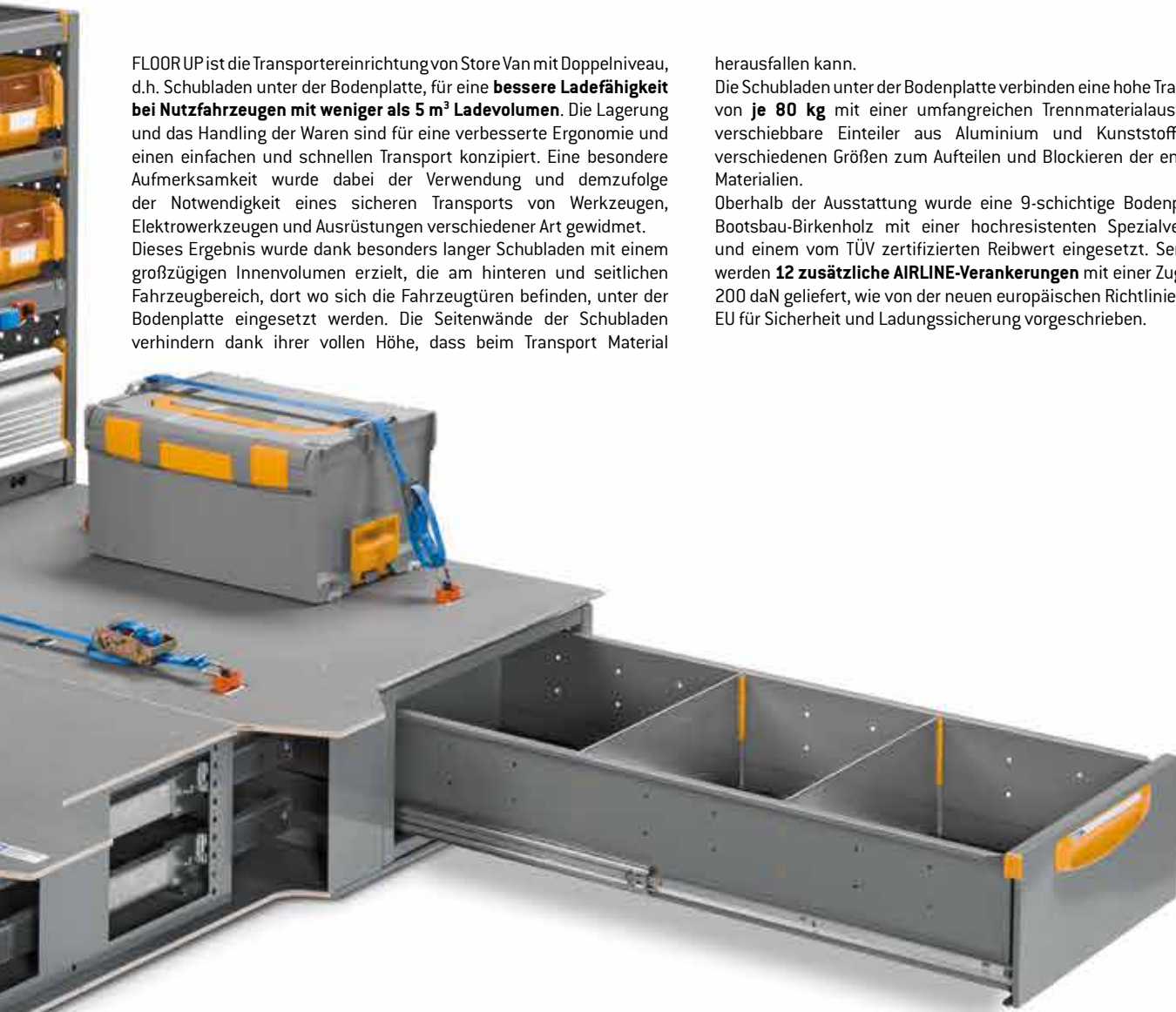

FLOOR UP is the double level outfitting system for vans with under-floor drawers developed by Store Van to **improve the load capacity of light-duty vehicles with cargo volumes below 5 m³**. Goods storage and handling have been designed to improve ergonomics and make transport easy and fast - with special focus on the use, and the resulting need for safe transport, of tools, power tools and equipment in general. This result has been achieved thanks to the introduction of extra long under-floor drawers with a large internal volume, placed at the rear end and along the sides of vehicles next to the doors. The full-height side walls of the drawers prevent the contents from spilling out during transport.

The under-floor drawers combine high capacity, **80 kg per drawer**, with

a wide range of separation items, such as movable aluminium dividers and plastic boxes of various sizes to divide, contain and secure any contained material.

In the upper part of the outfitting a 9-layer marine birch wood floor has been added, with special high-strength coating with TUV-certified friction coefficient. **12 additional AIRLINE anchor points** with 200 daN pulling strength are supplied as standard, in compliance with the new EU directive 2014/47/EU regarding safety and load securing.

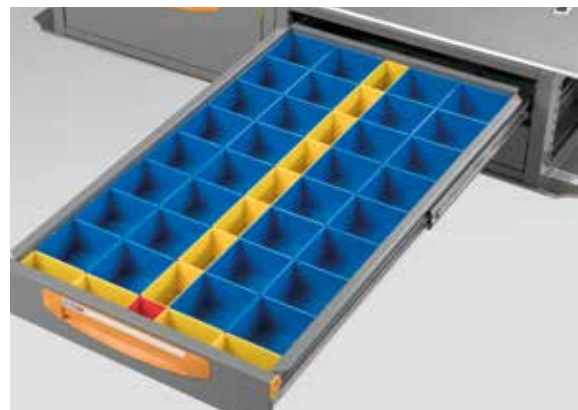

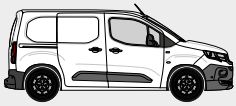

L1 H1

OPEL COMBO
KASTENWAGEN - PANEL VAN

FLOOR UP 250

FAHRZEUGEINRICHTUNGSBEISPIELE - FITTINGS EXAMPLES

BODENPLATTE H 250 mm – FLOORING H 250 mm

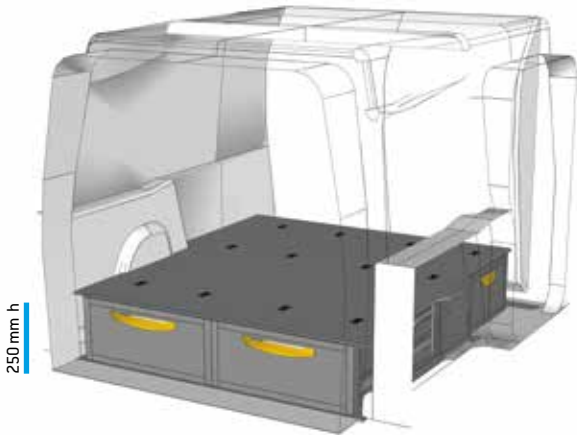

BEISPIEL - EXAMPLE

PA 0250 01*

B=1421 T=1600 H=268 mm - W=1421 D=1600 H=268 mm
(nur für Kabinenrückwand aus Vollblech / only for sheet steel bulkhead)

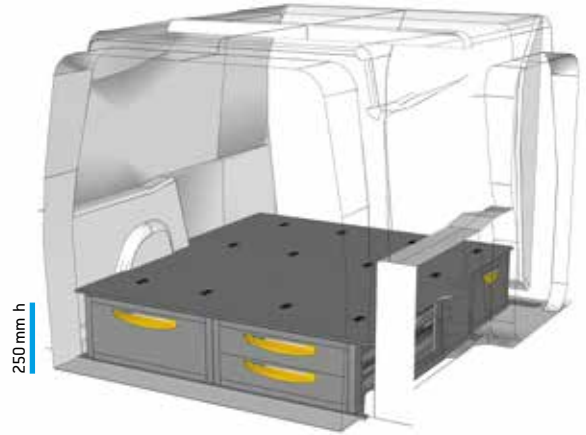

BEISPIEL - EXAMPLE

PA 0250 02*

B=1421 T=1600 H=268 mm - W=1421 D=1600 H=268 mm
(nur für Kabinenrückwand aus Vollblech / only for sheet steel bulkhead)

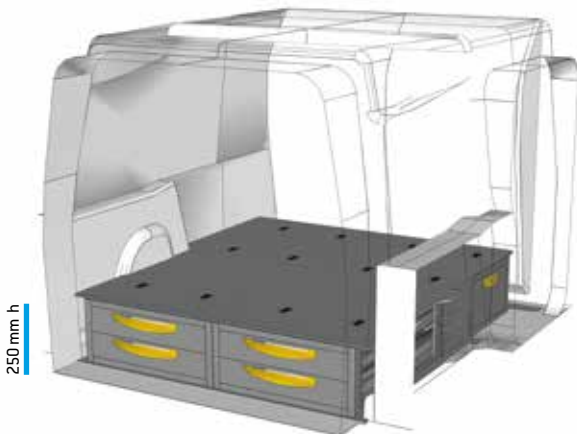
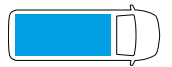

BEISPIEL - EXAMPLE

PA 0250 03*

B=1421 T=1600 H=268 mm - W=1421 D=1600 H=268 mm
(nur für Kabinenrückwand aus Vollblech / only for sheet steel bulkhead)

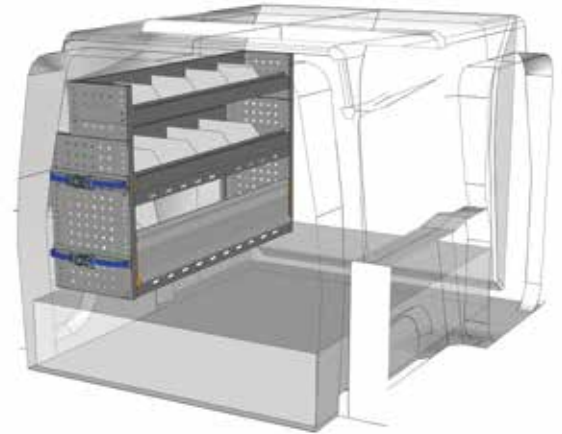

BEISPIEL - EXAMPLE

PA 1208 02*

B=1225 T=365 H=800 mm - W=1225 D=365 H=800 mm

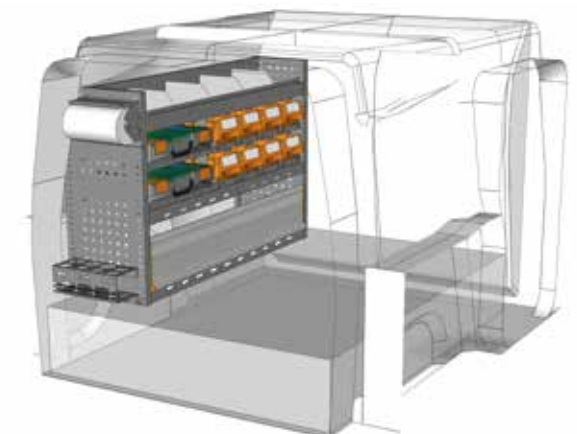
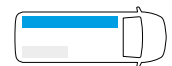

BEISPIEL - EXAMPLE

PA 1208 01*

B=1225 T=365 H=800 mm - W=1225 D=365 H=800 mm

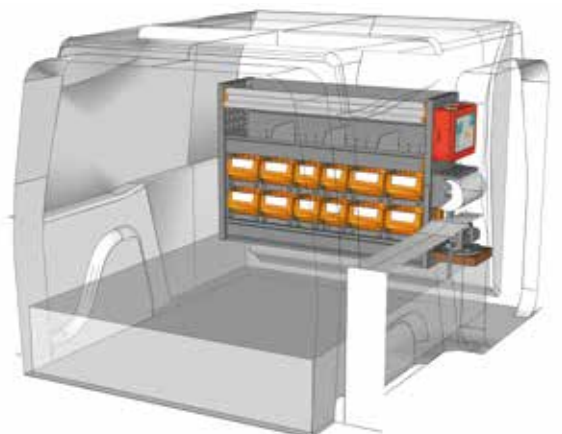

BEISPIEL - EXAMPLE

PA 1007 01*

B=1016 T=265 H=700 mm - W=1016 D=265 H=700 mm



* Einschließlich Befestigungskit - Fixing kit included

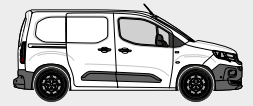

BODENPLATTE H 250 mm – FLOORING H 250 mm

FAHRZEUGEINRICHTUNGSBEISPIELE - FITTINGS EXAMPLES

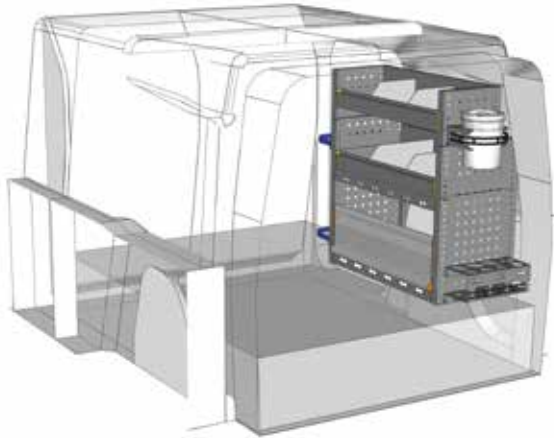

BEISPIEL - EXAMPLE

PA 0708 01*

B=717 T=365 H=800 mm - W=717 D=365 H=800 mm

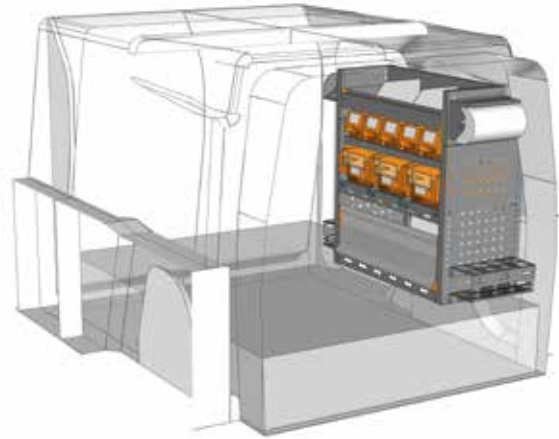
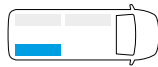

BEISPIEL - EXAMPLE

PA 0708 02*

B=717 T=365 H=800 mm - W=717 D=365 H=800 mm

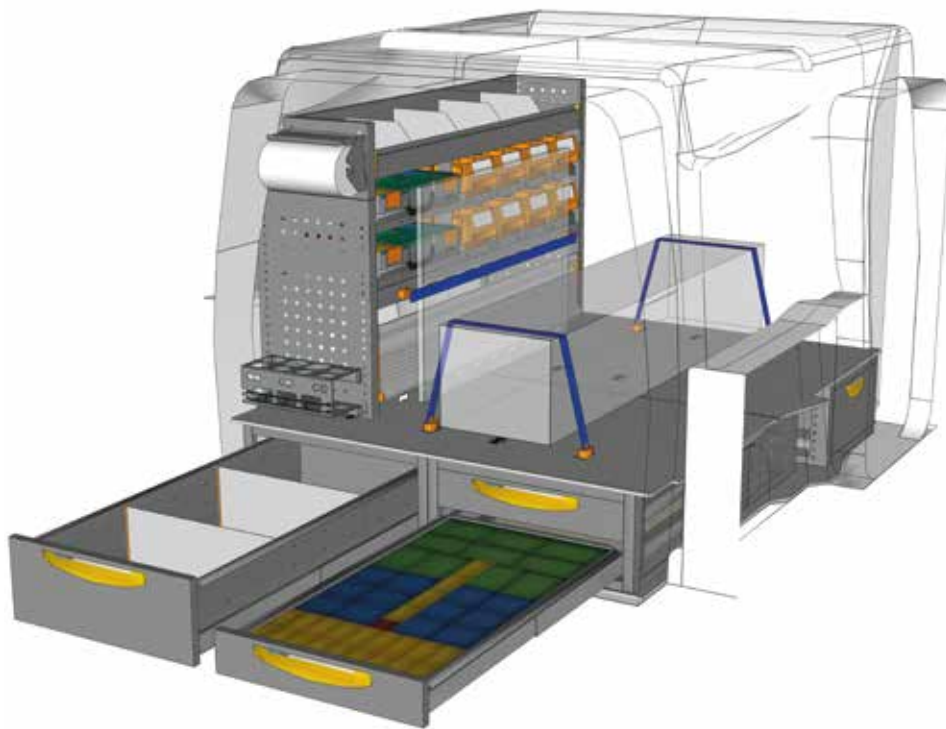
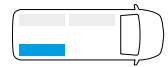

BEISPIEL - EXAMPLE

EXAMPLE PA L1H1 F1*

- 1 x PA 0250 02
- 1 x PA 1208 01
- 1 x E8 108042 B4
- 1 x E8 093058 F0
- 1 x E8 093058 L0
- 1 x E8 108058 B4
- 3 x V22124



siehe Seiten 10/11
see pages 10/11

* Einschließlich Befestigungskit - Fixing kit included

Haben Sie Ihre Einrichtung nicht gefunden?
Verlassen Sie sich auf die Profis für Fahrzeugeinrichtungen.

Auf der Rückseite dieses Katalogs finden Sie die nächstgelegene StoreVan Niederlassung. Besuchen Sie unsere Web-Seite.

Didn't find the equipment you're looking for?
Leave it to our experts.

See the back of this catalogue and contact the nearest StoreVan point or visit our website.





L1 H1

OPEL COMBO
KASTENWAGEN - PANEL VAN

FLOOR UP 350

FAHRZEUGEINRICHTUNGSBEISPIELE - FITTINGS EXAMPLES

BODENPLATTE H 350 mm – FLOORING H 350 mm

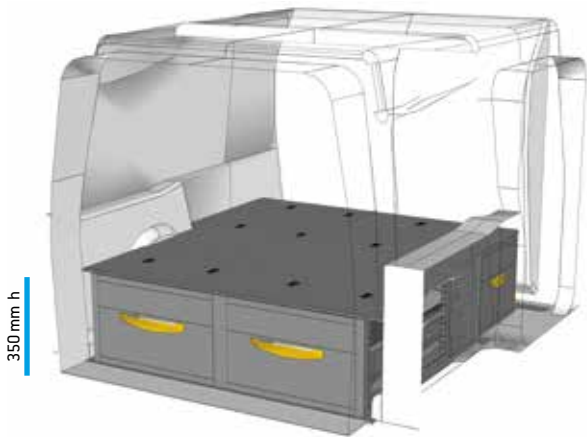

BEISPIEL - EXAMPLE

PA 0350 01*

B=1420 T=1576 H=368 mm - W=1420 D=1576 H=368 mm
(nur für Kabinenrückwand aus Vollblech / only for sheet steel bulkhead)

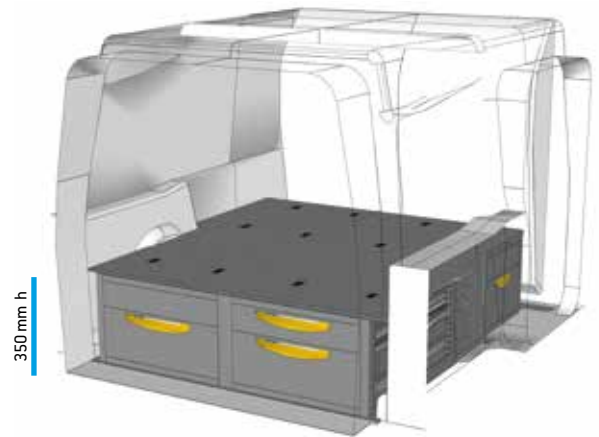

BEISPIEL - EXAMPLE

PA 0350 02*

B=1420 T=1576 H=368 mm - W=1420 D=1576 H=368 mm
(nur für Kabinenrückwand aus Vollblech / only for sheet steel bulkhead)

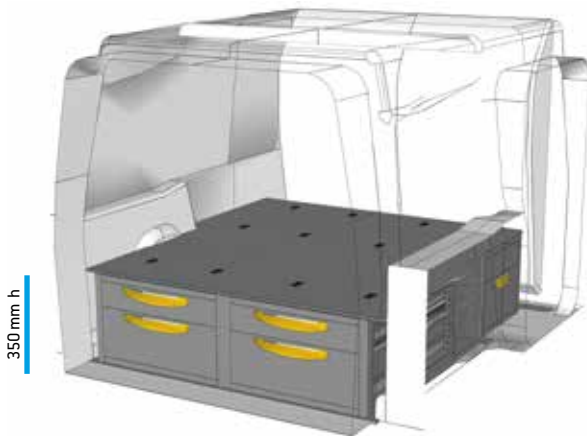
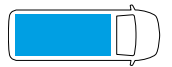

BEISPIEL - EXAMPLE

PA 0350 03*

B=1420 T=1576 H=368 mm - W=1420 D=1576 H=368 mm
(nur für Kabinenrückwand aus Vollblech / only for sheet steel bulkhead)

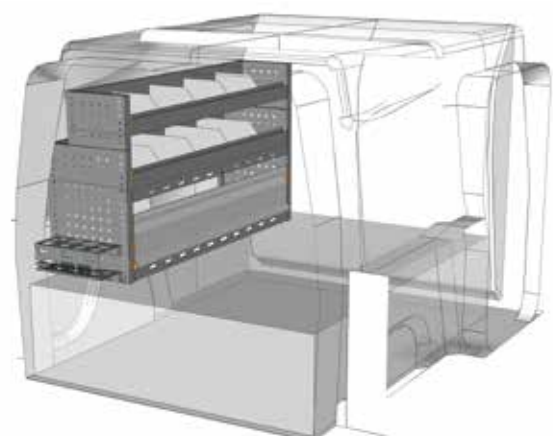

BEISPIEL - EXAMPLE

PA 1207 02*

B=1225 T=365 H=700 mm - W=1225 D=365 H=700 mm

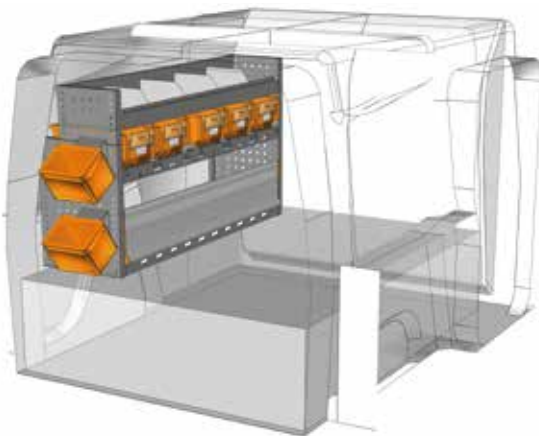
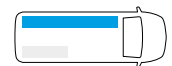

BEISPIEL - EXAMPLE

PA 1207 01*

B=1225 T=365 H=700 mm - W=1225 D=365 H=700 mm

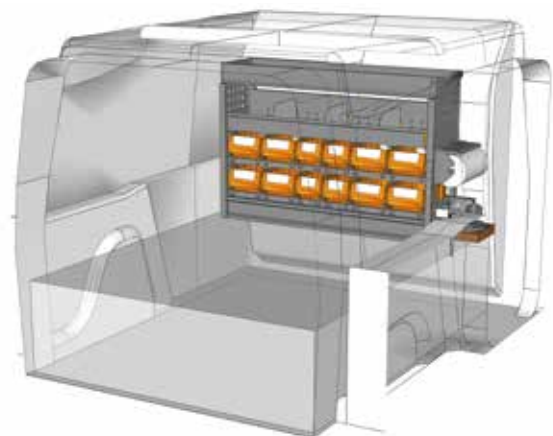

BEISPIEL - EXAMPLE

PA 1007 02*

B=1016 T=265 H=700 mm - W=1016 D=265 H=700 mm



* Einschließlich Befestigungskit - Fixing kit included

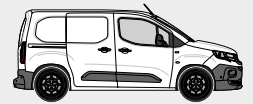

BODENPLATTE H 350 mm – FLOORING H 350 mm

FAHRZEUGEINRICHTUNGSBEISPIELE - FITTINGS EXAMPLES

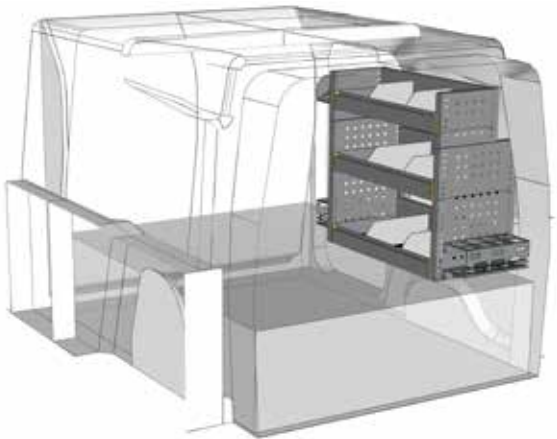

BEISPIEL - EXAMPLE

PA 0707 01*

B=717 T=365 H=700 mm - W=717 D=365 H=700 mm

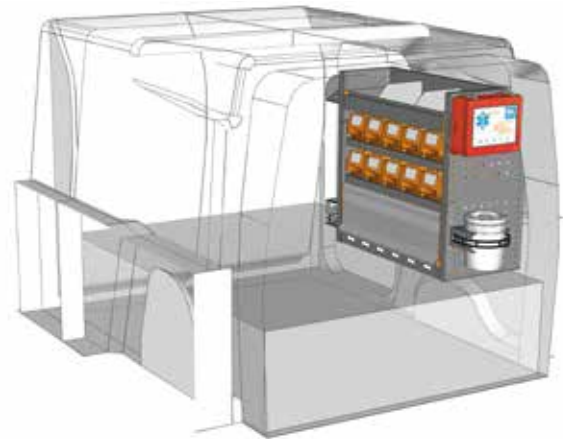
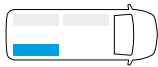

BEISPIEL - EXAMPLE

PA 0707 02*

B=717 T=365 H=700 mm - W=717 D=365 H=700 mm

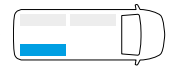

KASTENWAGEN - PANEL VAN
OPEL COMBO

FLOOR UP 350

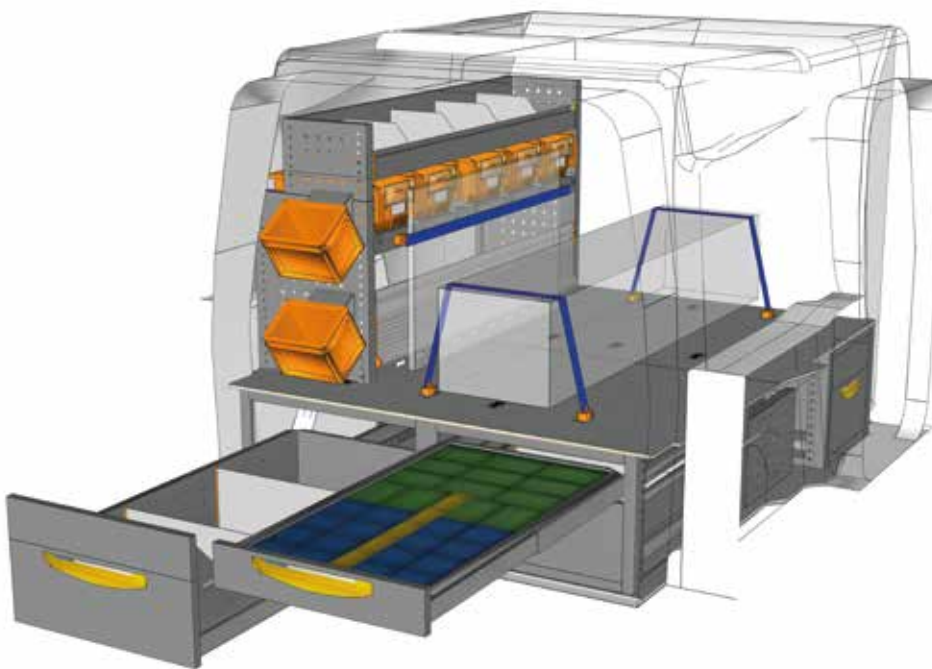

BEISPIEL - EXAMPLE

EXAMPLE PA L1H1 F2*

- 1 X PA 0350 02
- 1 X PA 1207 01
- 2 X E8 108058 B4
- 1 X E8 093058 G0
- 1 X E8 108042 B4
- 3 X V22124



siehe Seiten 10/11
see pages 10/11

* Einschließlich Befestigungskit - Fixing kit included

Haben Sie Ihre Einrichtung nicht gefunden?
Verlassen Sie sich auf die Profis für Fahrzeugeinrichtungen.

Auf der Rückseite dieses Katalogs finden Sie die nächstgelegene StoreVan Niederlassung. Besuchen Sie unsere Web-Seite.

Didn't find the equipment you're looking for?
Leave it to our experts.

See the back of this catalogue and contact the nearest StoreVan point or visit our website.



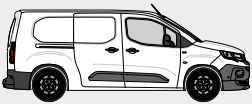

L2 H1

OPEL COMBO
KASTENWAGEN - PANEL VAN

FLOOR UP 250

FAHRZEUGEINRICHTUNGSBEISPIELE - FITTINGS EXAMPLES

BODENPLATTE H 250 mm – FLOORING H 250 mm

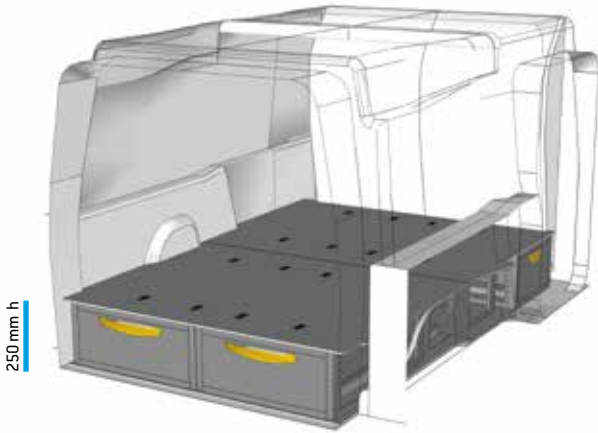

BEISPIEL - EXAMPLE

PA 0250 21*

B=1421 T=1954 H=268 mm - W=1421 D=1954 H=268 mm
(nur für Kabinenrückwand aus Vollblech / only for sheet steel bulkhead)

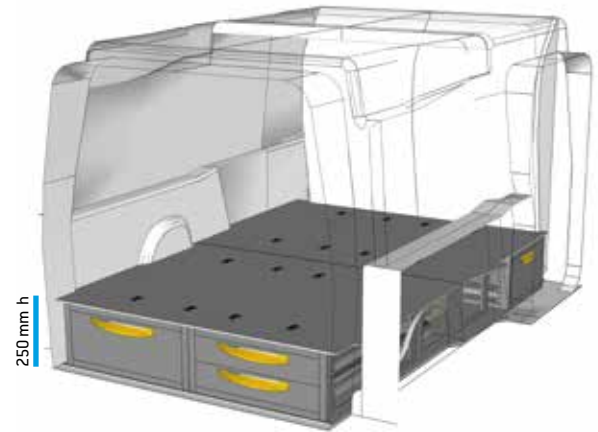

BEISPIEL - EXAMPLE

PA 0250 22*

B=1421 T=1954 H=268 mm - W=1421 D=1954 H=268 mm
(nur für Kabinenrückwand aus Vollblech / only for sheet steel bulkhead)

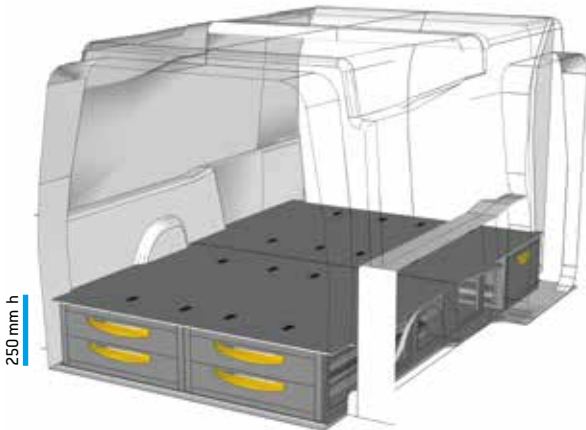

BEISPIEL - EXAMPLE

PA 0250 23*

B=1421 T=1954 H=268 mm - W=1421 D=1954 H=268 mm
(nur für Kabinenrückwand aus Vollblech / only for sheet steel bulkhead)

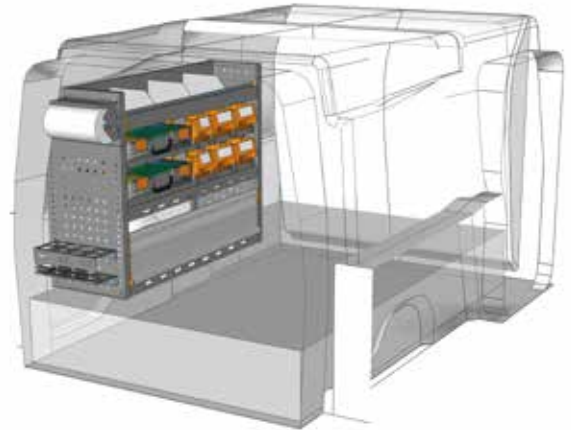

BEISPIEL - EXAMPLE

PA 1008 01*

B=1016 T=365 H=800 mm - W=1016 D=365 H=800 mm

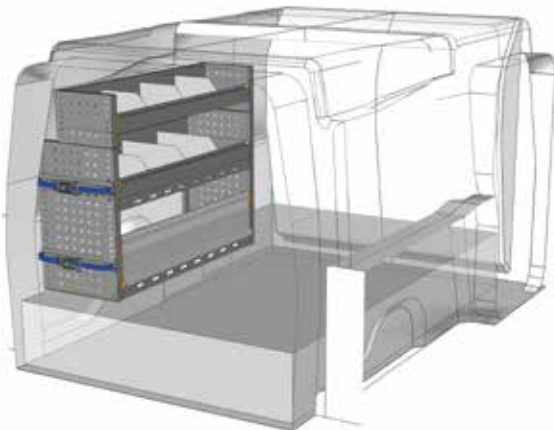
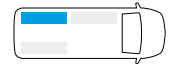

BEISPIEL - EXAMPLE

PA 1008 02*

B=1016 T=365 H=800 mm - W=1016 D=365 H=800 mm

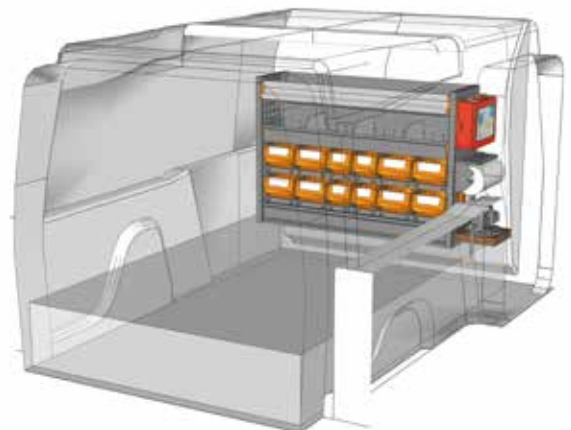
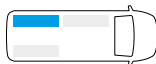

BEISPIEL - EXAMPLE

PA 1007 03*

B=1016 T=265 H=700 mm - W=1016 D=265 H=700 mm



* Einschließlich Befestigungskit - Fixing kit included

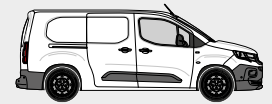

BODENPLATTE H 250 mm – FLOORING H 250 mm

FAHRZEUGEINRICHTUNGSBEISPIELE - FITTINGS EXAMPLES

Ansicht von der Schiebetür
View from side door

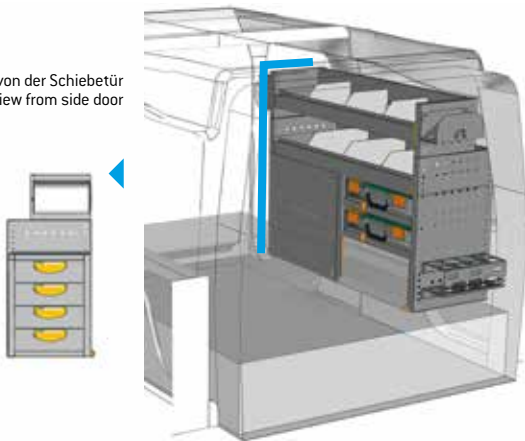

BEISPIEL - EXAMPLE

PA 1008 03*

B=1016 T=365 H=800 mm - W=1016 D=365 H=800 mm

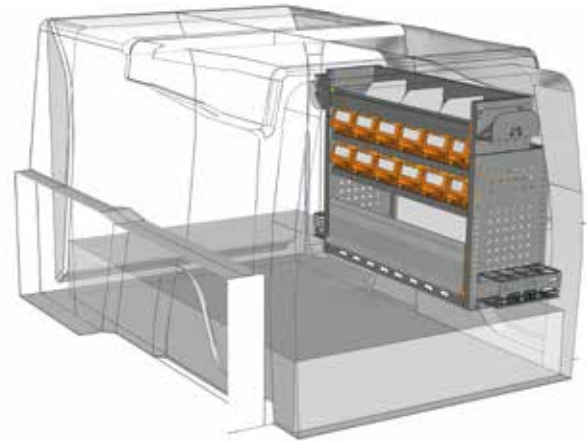
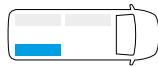

BEISPIEL - EXAMPLE

PA 1008 04*

B=1016 T=365 H=800 mm - W=1016 D=365 H=800 mm

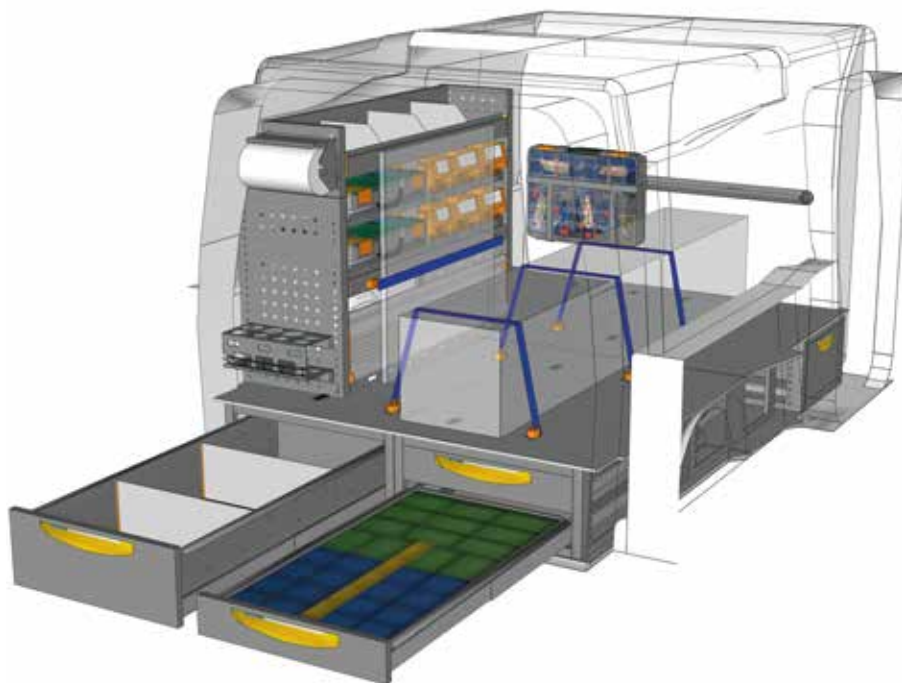
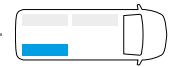

BEISPIEL - EXAMPLE

EXAMPLE PA L2H1 F1*

- | | |
|------------------|-------------|
| 1 x PA 0250 22 | 1 x BOX080 |
| 1 x PA 1008 01 | 1 x CPV080 |
| 1 x E8 108058 B4 | 2 x V22136 |
| 1 x E8 093058 F0 | 2 x V22124 |
| 1 x E8 093058 G0 | 2 x V22148 |
| 1 x E8 108042 B4 | 1 x YELLOW |
| 1 x V18029 10 | 4 x V225820 |
| 2 x V22106 | |



siehe Seiten 10/11
see pages 10/11

* Einschließlich Befestigungskit - Fixing kit included

Haben Sie Ihre Einrichtung nicht gefunden?
Verlassen Sie sich auf die Profis für Fahrzeugeinrichtungen.
Auf der Rückseite dieses Katalogs finden Sie die nächstgelegene StoreVan Niederlassung. Besuchen Sie unsere Web-Seite.

Didn't find the equipment you're looking for?
Leave it to our experts.
See the back of this catalogue and contact the nearest StoreVan point or visit our website.



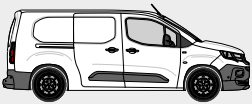

L2 H1

OPEL COMBO
KASTENWAGEN - PANEL VAN

FLOOR UP 350

FAHRZEUGEINRICHTUNGSBEISPIELE - FITTINGS EXAMPLES

BODENPLATTE H 350 mm – FLOORING H 350 mm

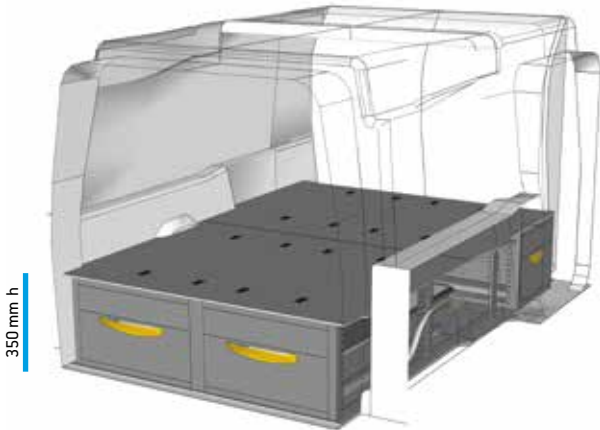

BEISPIEL - EXAMPLE

PA 0350 21*

B=1420 T=1927 H=368 mm - W=1420 D=1927 H=368 mm
(nur für Kabinenrückwand aus Vollblech / only for sheet steel bulkhead)

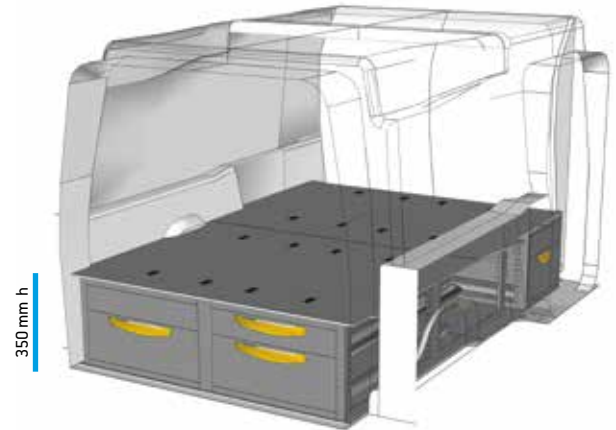

BEISPIEL - EXAMPLE

PA 0350 22*

B=1420 T=1927 H=368 mm - W=1420 D=1927 H=368 mm
(nur für Kabinenrückwand aus Vollblech / only for sheet steel bulkhead)

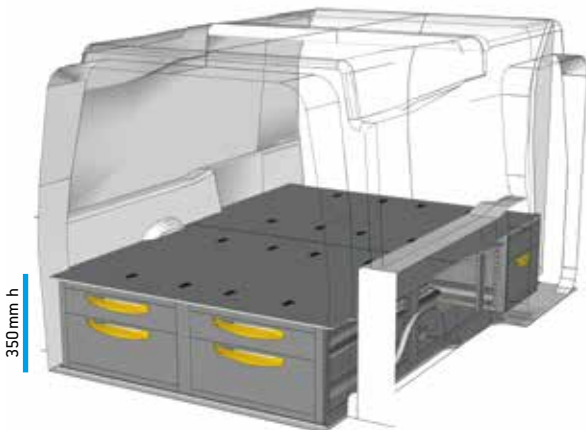
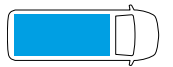

BEISPIEL - EXAMPLE

PA 0350 23*

B=1420 T=1927 H=368 mm - W=1420 D=1927 H=368 mm
(nur für Kabinenrückwand aus Vollblech / only for sheet steel bulkhead)

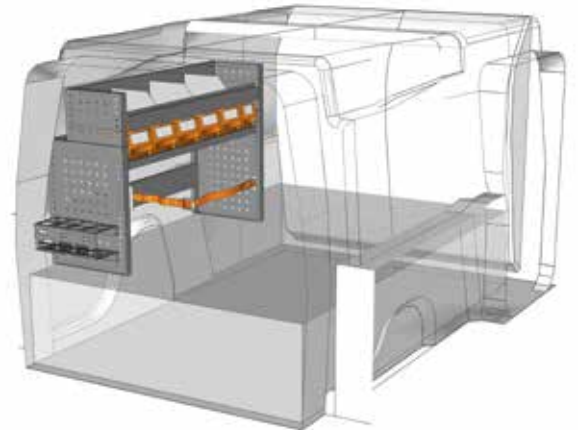

BEISPIEL - EXAMPLE

PA 1007 04*

B=1016 T=365 H=700 mm - W=1016 D=365 H=700 mm

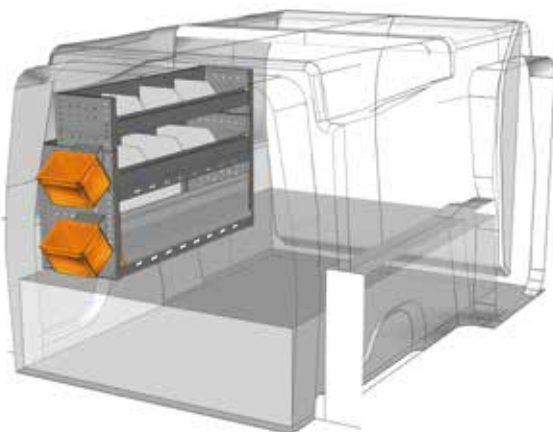
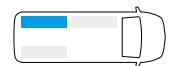

BEISPIEL - EXAMPLE

PA 1007 05*

B=1016 T=365 H=700 mm - W=1016 D=365 H=700 mm

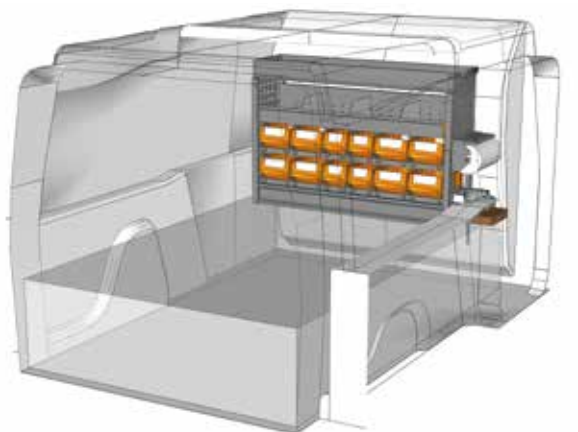
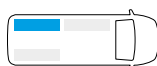

BEISPIEL - EXAMPLE

PA 1007 06*

B=1016 T=265 H=700 mm - W=1016 D=265 H=700 mm

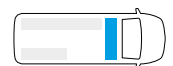

* Einschließlich Befestigungskit - Fixing kit included

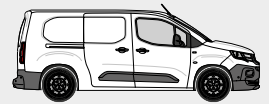

BODENPLATTE H 350 mm – FLOORING H 350 mm

FAHRZEUGEINRICHTUNGSBEISPIELE - FITTINGS EXAMPLES

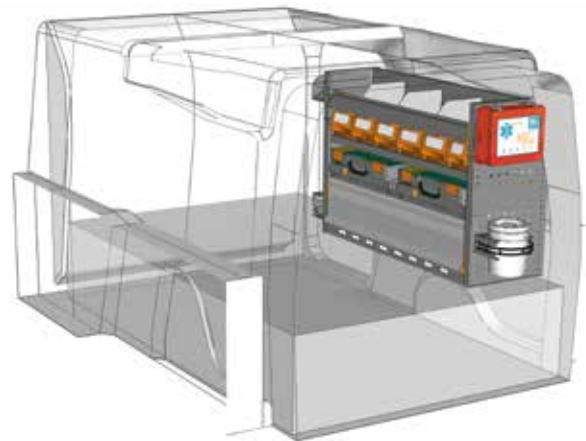
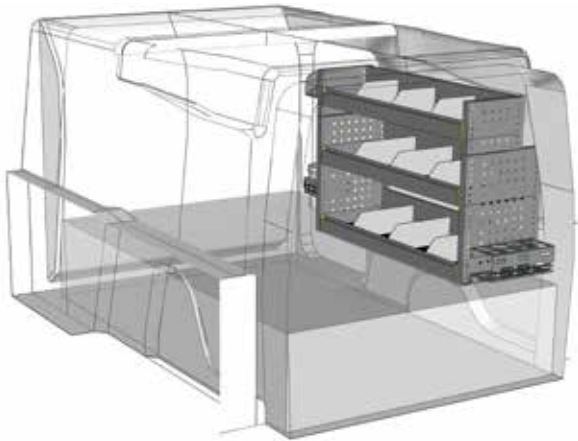

BEISPIEL - EXAMPLE

PA 1007 07*

B=1016 T=365 H=700 mm - W=1016 D=365 H=700 mm

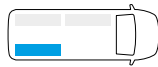

BEISPIEL - EXAMPLE

PA 1007 08*

B=1016 T=365 H=700 mm - W=1016 D=365 H=700 mm

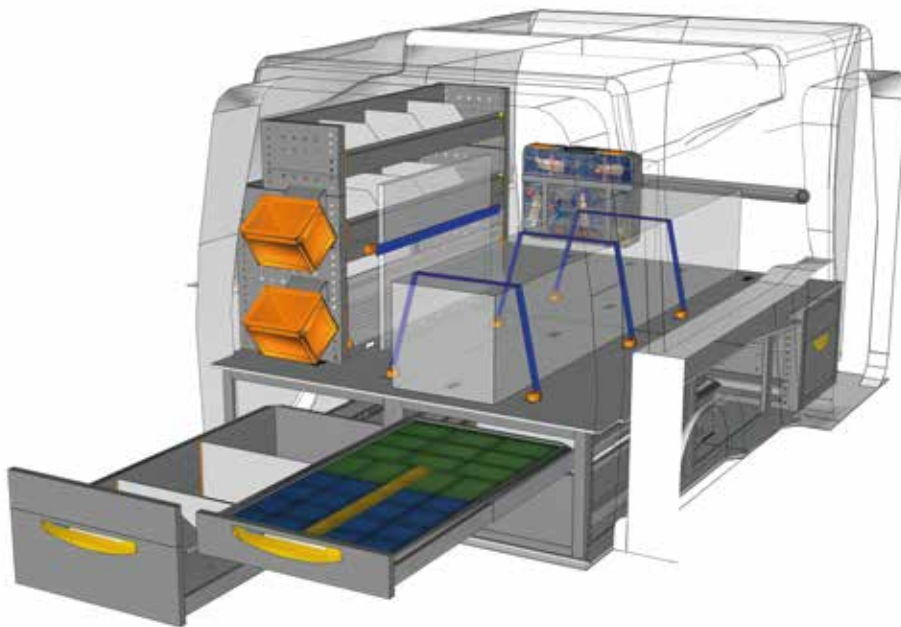
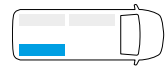

BEISPIEL - EXAMPLE

EXAMPLE PA L2H1 F2*

- | | |
|------------------|-------------|
| 1 x PA 0350 22 | 1 x CPV080 |
| 1 x PA 1007 05 | 2 x V22136 |
| 2 x E8 108058 B4 | 2 x V22124 |
| 1 x E8 093058 G0 | 2 x V22148 |
| 1 x E8 108042 B4 | 1 x YELLOW |
| 1 x V18029 10 | 4 x V225820 |
| 2 x V22106 | |
| 1 x BOX080 | |



siehe Seiten 10/11
see pages 10/11

* Einschließlich Befestigungskit - Fixing kit included

Haben Sie Ihre Einrichtung nicht gefunden?
Verlassen Sie sich auf die Profis für Fahrzeugeinrichtungen.
Auf der Rückseite dieses Katalogs finden Sie die nächstgelegene StoreVan Niederlassung. Besuchen Sie unsere Web-Seite.

Didn't find the equipment you're looking for?
Leave it to our experts.
See the back of this catalogue and contact the nearest StoreVan point or visit our website.



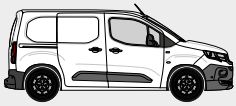

FAHRZEUG VEHICLE	DACHTRÄGER ROOF RACK	ABMESSUNGEN DIMENSIONS	GEWICHT WEIGHT	TRAGKRAFT LOAD CAPACITY
	ART.			
Fahrzeugtyp - Model L1 H1	POT 021	2250x1400 mm	22,85 kg	96,00 kg
Fahrzeugtyp - Model L2 H1	POT 022	2750x1400 mm	27,75 kg	92,00 kg

- Nur für Fahrzeug mit Heckflügeltüren.
- Only for vehicle with rear leaf doors.

POT

- Dachträger bestehend aus:
 - Alu-Querschienen inkl. Befestigungen und Gummiprofilen
 - Seitenwänden aus Aluminium
 - Laderolle aus Aluminium
 - Schraubmaterial aus Edelstahl

- Roof rack complete of:
 - aluminium crossbars with fixing parts and rubber profile
 - aluminium side rails
 - aluminium loading roller
 - fixing screws in stainless steel



FAHRZEUG VEHICLE	LEITERTRÄGER LADDER RACK	ABMESSUNGEN DIMENSIONS	GEWICHT WEIGHT	TRAGKRAFT LOAD CAPACITY
	ART.			
Fahrzeugtyp - Model L1 H1	POS 021	2250x1380 mm	46,95 kg	73,00 kg
Fahrzeugtyp - Model L2 H1	POS 022	2750x1380 mm	54,35 kg	65,00 kg

- Nur für Fahrzeug mit Heckflügeltüren. Der Leiterträger kann links oder rechts montiert werden.
- Only for vehicle with rear leaf doors. The ladder rack rail can be mounted on the right or left side.

POS

- Leiterträger bestehend aus:
 - Alu-Querschienen inkl. Befestigungen und Gummiprofilen
 - Seitenwand aus Aluminium
 - Laderolle aus Aluminium
 - Leiterschiene aus Aluminium und Edelstahl
 - Schraubmaterial aus Edelstahl

- Ladder rack complete of:
 - aluminium crossbars with fixing parts and rubber profile
 - aluminium side rail
 - aluminium loading roller
 - ladder rack rail made of aluminium and stainless steel
 - fixing screws in stainless steel





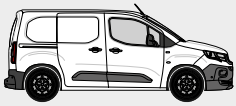

ART. NR. / ITEM NO. **PAP 265 00**

- Papierrollenhalter mit Papierrolle Ø 130 mm
- Paper towel holder kit with paper towel Ø 130 mm



ART. NR. / ITEM NO. **CAB 220 00**

- Schlauchhalter
- Cable saddle



ART. NR. / ITEM NO. **SPR 365 00**

- Spraydosenhalter T=365 mm
- Spray-can holder kit D=365 mm



ART. NR. / ITEM NO. **PAP 365 00**

- Papierrollenhalter mit Papierrolle Ø 240 mm
- Paper towel holder kit with paper towel Ø 240 mm



ART. NR. / ITEM NO. **CAB 296 00**

- Schlauchhalter-Satz
- Cable saddle-kit



ART. NR. / ITEM NO. **SIL 296 00**

- Kartuschen - Spraydosen halter
- Kit silicone - spray cans holder



ART. NR. / ITEM NO. **AID 265 00**

- Verbandkasten
- First aid kit



ART. NR. / ITEM NO. **DOC 365 00**

- Plantasche A4 - 362x68x209 mm H
- A4 documents holder - 362x68x209 mm H



ART. NR. / ITEM NO. **SPR 160 00**

- Satz 2-Stellen Spraydosenhalter
- Spray-can holder kit [2 slots]



ART. NR. / ITEM NO. **LED 001 00**

- Led Lampe IP20 12V B=600 mm
- Led lamp IP20 12V W=600 mm



ART. NR. / ITEM NO. **WAS 365 00**

- Handwasch Kit
- Hand wash kit



ART. NR. / ITEM NO. **WW MOBILE 1**

- Klapptisch Work Wood - 980x423x802 mm H
- Table with folding legs - 980x423x802 mm H

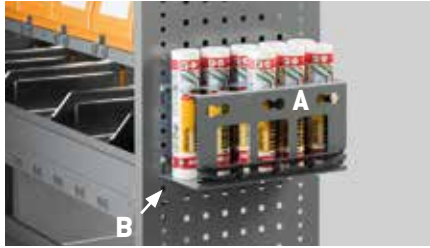
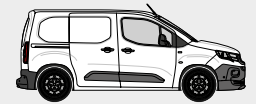

Kartuschenhalter
Kit silicone holder

A + B

ART. NR. / ITEM NO. **BAR 296 00**

A

- Träger für Silikon-Kartuschen- / Gewindestangenhalter
- Support for silicone cartridges / threaded-bar holder

ART. NR. / ITEM NO. **BAR 296 02**

B

- Adapter für Silikon-Kartuschen
- Adapter for silicone cartridges

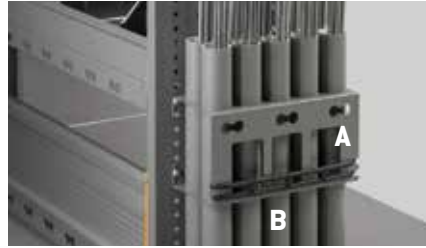

Gewindestangenhalter-Satz
Threaded-bar holder kit

A + B

ART. NR. / ITEM NO. **BAR 296 00**

A

- Träger für Silikon-Kartuschen- / Gewindestangenhalter
- Support for silicone cartridges / threaded-bar holder

ART. NR. / ITEM NO. **BAR 296 01**

B

- 5 Rohren für Gewindestangenhalter
- 5 Pipe for threaded-bar holder

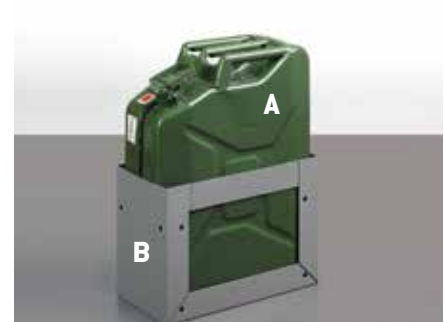

ART. NR. / ITEM NO. **OIL 20L 00**

A

- Stahlkanister inhalt 20 LT
- Metal can capacity 20 LT

ART. NR. / ITEM NO. **OIL 365 00**

B

- Kanisterhalter
- Can holder

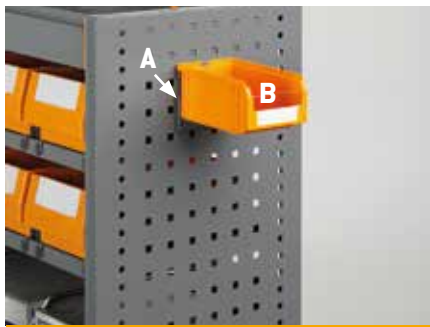

ART. NR. / ITEM NO. **BL 7433 00**

A

- Behälterschiene für 1 Behälter gröÙe 1PL
- Container rail for 1 container size 1PL



ART. NR. / ITEM NO. **BL 7434 00**

A

- Behälterschiene für 3 Behältern gröÙe 1PL
- Container rail for 3 containers size 1PL

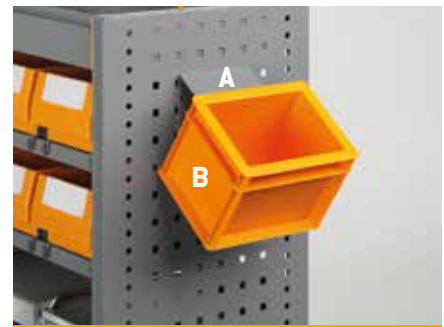

ART. NR. / ITEM NO. **BL 7432 00**

A

- Behälterschiene für 1 Behälter Euro Box
- Container rail for 1 container Euro Box

ART. NR. / ITEM NO. **PM 1751 00**

B

- Kunststoffbehälter gröÙe 1PL
- Polypropylene container size 1PL

ART. NR. / ITEM NO. **PM 1751 00**

B

- Kunststoffbehälter gröÙe 1PL
- Polypropylene container size 1PL

ART. NR. / ITEM NO. **PA 2251 A0**

B

- Kunststoffkasten aus Polypropylen serie Euro Box
- Polypropylene boxes series Euro Box



ART. NR. / ITEM NO. **MAG 020**

- Magnetensatz 10 Stk Ø 20 mm
- Set of 10 magnets Ø 20 mm

ART. NR. / ITEM NO. **MAG 025**

- Magnetensatz 10 Stk Ø 25 mm
- Set of 10 magnets Ø 25 mm



ART. NR. / ITEM NO. **RUB 160 00**

- Halter für Ladungssicherungspads
158x50x171 mm H
- Non-slip mats holder - 158x50x171 mm H

ART. NR. / ITEM NO. **RUB 000 00**

- Satz 6 Ladungssicherungspads - 150x150x3 mm H
- 6 non-slip mats kit - 150x150x3 mm H



ANWENDUNGSBEISPIEL FÜR SATZ LADUNGSSICHERUNGSPADS

Die Antirutschmatten ermöglichen den Reibungswert bis zu $\mu_D 0.6$ nach DIN EN 12195-1: 2004 und VDI 2700 ff zu erhöhen. Das Messverfahren befolgt die Richtlinie „VDI 2700 - 15“.

USE CASE FOR NON-SLIP MAT

Non-slip mats are used to increase the coefficient of friction up to $\mu_D 0.6$ following the calculus DIN EN 12195-1: 2004 and VDI 2700 ff. The measuring procedure should follow the directive "VDI 2700 - 15"

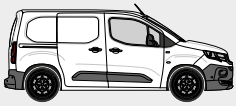

ART. NR. / ITEM NO. **FIR 000** A

- Gasflaschenhalter
- Gas cylinder kit

ART. NR. / ITEM NO. **FIR 4KG** B

- Feuerloescher (Pulver) 4 KG
- Fire extinguisher (powder) 4 KG



ART. NR. / ITEM NO. **V18029 03** A

- Horizontale Lasthalteschiene mit medium Lochung B=365 mm
- Horizontal load restraining bar with medium hole connector W=365 mm

ART. NR. / ITEM NO. **V18029 04** A

- Horizontale Lasthalteschiene mit medium Lochung B=445 mm
- Horizontal load restraining bar with medium hole connector W=445 mm

ART. NR. / ITEM NO. **V22868** B

- Zurrgurte mit Ratschenschloss mit medium Anschlussteil
- Medium connector ratchet load restraining belt

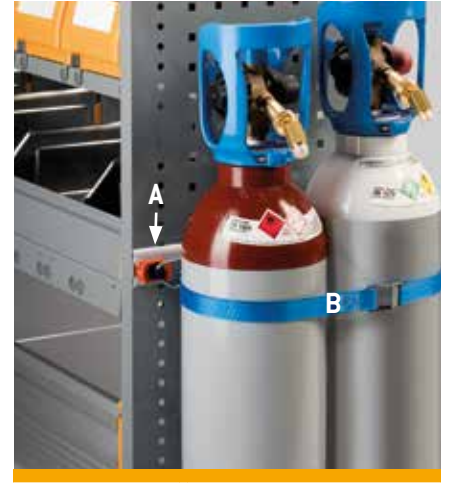

ART. NR. / ITEM NO. **V18029 03** A

- Horizontale Lasthalteschiene mit medium Lochung B=365 mm
- Horizontal load restraining bar with medium hole connector W=365 mm

ART. NR. / ITEM NO. **V18029 04** A

- Horizontale Lasthalteschiene mit medium Lochung B=445 mm
- Horizontal load restraining bar with medium hole connector W=445 mm

ART. NR. / ITEM NO. **V22869** B

- Zurrgurte mit Hebelspannschloss mit medium Anschlussteil
- Medium connector clamp load restraining belt



Beispiel mit
2 ART. NR. / ITEM NO. **FIR 000**
Example with
2 ART. NR. / ITEM NO. **FIR 000**



Beispiel mit
2 ART. NR. / ITEM NO. **V18029 03**
2 ART. NR. / ITEM NO. **V22868**
Example with
2 ART. NR. / ITEM NO. **V18029 03**
2 ART. NR. / ITEM NO. **V22868**



Beispiel mit
2 ART. NR. / ITEM NO. **V18029 03**
2 ART. NR. / ITEM NO. **V22869**
Example with
2 ART. NR. / ITEM NO. **V18029 03**
2 ART. NR. / ITEM NO. **V22869**

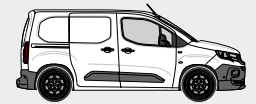

ART. NR. / ITEM NO. **00 ROLL SU** A

- Schienenträger-Satz für STORE BOX ROLL
- Set of supports for STORE BOX ROLL

ART. NR. / ITEM NO. **00 ROLL 00** B

- Plattform mit Rollen mit Bremsen für Koffer BOX 102-136-238-374
- Trolley with castors with brakes for tool case BOX 102-136-238-374



KASTENWAGEN - PANEL VAN
OPEL COMBO



OPEL COMBO

LIEFERBEDINGUNGEN

- Bodenplatten und Seitenverkleidungen werden in mehreren Teilen geliefert.
- Dachträger und Leiterträger werden **lose** geliefert.
- Module werden **vormontiert** komplett mit Fahrzeugbefestigungsmaterial geliefert.
- Produkte sollen vorzugsweise von **Vertragshändlern** installiert werden.
- Produkte werden **verpackt** geliefert.
- **3 Jahre Garantie** auf unsere Komponenten.
- Die Tragkräfte beziehen sich auf **gleichmäßig verteilte Last**.

SUPPLY CONDITIONS

- Flooring and linings supplied in several pieces.
- Roof and ladder racks supplied **flat-packed**.
- Modules are supplied **preassembled** complete of fixing material to the vehicle.
- For products installation, please get in touch with our **approved installer's network**.
- Products provided **with packaging**.
- Our products are covered by a **3-years warranty**.
- Load capacities refer to **uniformly distributed loads**.



FAMI S.R.L.

VIA STAZIONE ROSSANO, 13 – 36027 ROSÀ (VI) ITALY
TEL +39 0424 585455 R.A. – FAX +39 0424 585482
INFO@FAMISPA.COM – WWW.FAMISPA.COM

INFO@STOREVAN.COM – WWW.STOREVAN.COM

