



ALLESTIMENTI VEICOLI COMMERCIALI
AMÉNAGEMENTS DE VÉHICULES UTILITAIRES



MAN TGE





Store Van è l'unico produttore al mondo di allestimenti per veicoli commerciali ad utilizzare questa tecnologia.

StoreVan est le seul fabricant d'aménagements de véhicules utilitaires au monde à utiliser cette technologie.

TECNOLOGIE

ACCIAIO GALVANNEALED

La lamiera galvannealed è una variante della lamiera zincata a caldo. Il prodotto subisce un processo di zincatura a caldo e un successivo riscaldamento ad una temperatura di ca. 550°C attraverso il quale lo zinco si salda alla superficie della lamiera formando una lega con l'acciaio.

Il risultato che si ottiene è uno strato zincato uniforme e dalla struttura cristallina fine abbinati ad una **qualità della superficie e una resistenza alla corrosione nettamente superiori**. Questo processo è ideale per le applicazioni automotive. Store Van ha introdotto e implementato tale tecnologia anche nel settore dell'allestimento veicoli industriali.

VERNICIATURA PER IMMERSIONE - CATODICA - CON RESINA ACRILICA

La verniciatura per cataforesi è un trattamento superficiale di verniciatura in grado di conferire agli elementi dell'allestimento una **notevole resistenza alla corrosione**; è caratterizzata dal **deposito uniforme** di una resina acrilica sulla superficie dell'elemento, assicurando per lungo tempo un'elevata protezione nei confronti degli agenti chimici e di altri tipi di attacchi. La resina acrilica consente una diretta esposizione agli agenti atmosferici mantenendo inalterate le caratteristiche tecniche. Con questo processo si assicura una maggiore protezione dalla ruggine.

- Resistenza alla corrosione superiore a 500 ore (umidità ASTM D1735)
- Eccellente durezza con valutazione minima 2H



STORE VAN ORANGE PLANET

Sostenibilità ambientale e sviluppo eco-compatibile sono temi di rilevante attualità ed interesse, sorti dalla crescente consapevolezza che si debba prestare attenzione all'equilibrio ambientale.

STORE VAN ORANGE PLANET

La durabilità ambientale e lo sviluppo eco-compatibile sono temi di rilevante attualità ed interesse, sorti dalla crescente consapevolezza che si debba prestare attenzione all'equilibrio ambientale.

TECNOLOGIES

ACIER GALVANNEALED

La tôle galvannealed est une variante de la tôle galvanisée à chaud. Le produit est soumis à un procédé de galvanisation à chaud, puis de chauffage à une température d'env. 550 °C par lequel le zinc se soude à la surface de la tôle en formant un alliage avec l'acier.

Le résultat obtenu est une couche de zinc uniforme et une structure cristalline fine combinées à **une qualité de la surface et une résistance à la corrosion nettement plus élevées**. Ce procédé est idéal pour les applications au sein du secteur automobile. StoreVan a introduit et optimisé cette technologie également dans le domaine des aménagements de véhicules utilitaires.

PEINTURE PAR IMMERSION - CATHODIQUE - AVEC RESINE ACRYLIQUE

La peinture cathodique est un traitement de surface qui permet de conférer aux éléments de l'aménagement **une résistance remarquable à la corrosion** ; elle est caractérisée par le **dépôt uniforme** d'une résine acrylique sur la surface de l'élément, en garantissant une haute et durable protection contre les agents chimiques et d'autres types d'agressions. La résine acrylique permet une exposition directe aux agents atmosphériques, tout en conservant inchangées les caractéristiques techniques. Ce procédé garantit aussi une meilleure protection contre la rouille.

- Résistance à la corrosion supérieure à 500 heures (humidité ASTM D1735)
- Excellente dureté avec une évaluation minimale 2H



FISSAGGIO FLESSIBILE FIXATION FLEXIBLE

FLESSIBILITÀ E DUREVOLEZZA DEGLI ALLESTIMENTI PER FURGONI STORE VAN

Store Van utilizza uno speciale sistema a binario per il fissaggio delle scaffalature per furgoni allo chassis del veicolo commerciale, conferendo una grande flessibilità al posizionamento dei moduli e massimizzando l'utilizzo degli spazi interni al furgone attrezzato.

Il sistema prevede l'utilizzo di staffe che scorrono all'interno del binario in tutta la sua lunghezza anziché esser rivettate direttamente ai rinforzi dello chassis, che obbligano, nella progettazione dell'allestimento furgone, a una sostanziale rigidità nella gestione degli spazi. Il binario usato da Store Van viene fissato ai montanti verticali dell'officina mobile, con la doppia funzione di collegare in maniera uniforme gli scaffali per furgoni al telaio del veicolo e di distribuire omogeneamente tutte le forze dinamiche a cui l'allestimento viene sottoposto durante la guida.

Le staffe di fissaggio che collegano il binario al modulo presentano uno speciale snodo che ammortizza le vibrazioni derivanti dalla guida del veicolo, adattandosi ai movimenti torsionali dello chassis, specialmente in percorrenza di curve.

Grazie a questo sistema, i nostri allestimenti per furgoni possono esser progettati con la massima libertà, garantendo comunque alti standard di sicurezza, stabilità e durevolezza nel tempo.

Tutti i nostri sistemi di fissaggio si possono avvalere di sistemi di aggancio/sgancio rapido dei moduli tramite maniglie a ripresa che permettono di smontare l'allestimento senza l'ausilio di utensili. In questo modo la scaffalatura della tua officina mobile può essere dichiarata come materiale trasportato o come ausilio alla sicurezza del carico non permanentemente fissato al veicolo, come descritto nella DIRETTIVA 2014/47 UE, CAPO 1, Articolo 3, paragrafo 5.

FLEXIBILITÉ ET DURÉE DES AMÉNAGEMENTS POUR FOURGONS STORE VAN

Store Van utilise un système à rail spécial pour la fixation des rayonnages pour fourgons au châssis du véhicule utilitaire : cela garantit une grande flexibilité pour le positionnement des modules et optimise l'utilisation des espaces à l'intérieur du fourgon aménagé.

Le système prévoit l'utilisation d'étriers qui coulissent à l'intérieur du rail sur toute sa longueur au lieu d'être rivetés directement aux renforts du châssis, ce qui impose, dans la conception de l'aménagement du fourgon, une grande rigueur dans la gestion des espaces. Le rail utilisé par Store Van, fixé aux montants verticaux de l'atelier mobile, a une double fonction : solidariser de manière uniforme les rayonnages pour fourgons au châssis du véhicule et distribuer de manière homogène toutes les forces dynamiques auxquelles l'aménagement est soumis durant les déplacements.

Les étriers de fixation qui relient le rail au module présentent un dispositif articulé spécial qui amortit les vibrations causées par le déplacement du véhicule, en s'adaptant aux mouvements de torsion du châssis, en particulier dans les virages.

Grâce à ce système, nos aménagements pour fourgons peuvent être conçus avec la plus grande liberté, mais dans le respect de standards de sécurité, de stabilité et de durée élevés.

Tous nos systèmes de fixation peuvent bénéficier de systèmes d'accrochage/déaccrochage rapide des modules au moyen de poignées de serrage à cliquet qui permettent de démonter l'aménagement sans utiliser d'outils. Le rayonnage de votre atelier mobile peut ainsi être déclaré comme matériel transporté ou comme dispositif de sécurité du chargement fixé au véhicule de manière non permanente, conformément aux dispositions de la directive 2014/47 UE, chapitre 1, article 3, paragraphe 5.



CERTIFICAZIONI CERTIFICATIONS

PRODUZIONE CERTIFICATA

- Certificati ISO 9001:2015.
- Superata brillantemente la prova di CRASH TEST eseguita secondo le ultime normative europee ECE-R17 con impatto a 50 Km/h.
- Certificazione GS per l'arredo interno e le rampe di carico.
- Certificazione GS per il portatutto-portascale.

PRODUCTION CERTIFIÉE

- Certifiés ISO 9001:2015.
- ESSAI DE CHOC réalisé selon les normes européennes ECE-R17 les plus récentes avec impact à 50 km/h, passé brillamment.
- Certification GS pour l'aménagement interne et les rampes de chargement.
- Certification GS pour les galeries de toit et porte-échelles.

CRASH TEST
ECE-R17



La base per la protezione sicura dei veicoli

La base pour la protection
des véhicules en toute
sécurité



SICUREZZA DEL CARICO PER FURGONI E BLOCCAGGIO MERCE

Con il recepimento della direttiva 2014/47/EU verranno intensificati i controlli sui veicoli trasporto merci N2 e N3 e sensibilizzato il controllo del fissaggio del carico. La Direttiva consente agli Stati membri la possibilità di sottoporre a controlli tecnici veicoli che esulano dal suo ambito d'applicazione, come i veicoli commerciali della categoria N 1 e di controllare altri aspetti del trasporto e della sicurezza stradale.

SISTEMA DI PROTEZIONE DEL VANO DI CARICO E FISSAGGIO DEL CARICO

Il nuovo sistema di protezione integrato per furgoni ideato da Store Van segue le linee guida della nuova direttiva 2014/47/EU e consente il **fissaggio flessibile e sicuro** del carico ai pianali e alle pareti del veicolo.

Con l'impiego dei componenti di aggancio "Airline", e l'integrazione di numerosi accessori come cinghie, reti e pali telescopici, l'utilizzatore del veicolo può configurare la sua piattaforma di aggancio semplice, economica e a norma con la direttiva europea.

Il sistema prevede l'utilizzo di:

- pianali per furgoni in multistrato resina fenolica con predisposizione per gli ancoraggi originali del veicolo e ancoraggi supplementari (pag. 10) a filo pianale con trazione pari a 200 daN;
- barre in alluminio "Airline" ancorate allo châssis (pag. 11);
- pannellature in polipropilene ad alta flessibilità e resistenza per proteggere internamente la carrozzeria dagli urti accidentali (pag.8).

CON L'APPLICAZIONE DEL NUOVO KIT DI PROTEZIONE, SI PUÒ APPREZZARE UNA LUNGA SERIE DI VANTAGGI:

- l'utilizzatore del veicolo può già fissare il carico in sicurezza alle barre "Airline" tramite le cinghie di trattenuta.
- Il kit di fissaggio integrato prolunga la conservazione del buono stato della carrozzeria.
- Il sistema di protezione conferisce un valore aggiunto, qualità molto importante per il mercato del nuovo e fondamentale per quello dell'usato, solitamente compromesso da danneggiamenti.

SÉCURITÉ DU CHARGEMENT POUR LES FOURGONS ET BLOCAGE DE LA MARCHANDISE

Suite à la transposition de la directive 2014/47/EU, les contrôles sur les véhicules de transport de marchandises N2 et N3 s'intensifieront et le contrôle de la fixation du chargement fera l'objet d'une attention accrue. La directive offre aux États membres la possibilité de soumettre à des contrôles techniques les véhicules qui échappent à son champ d'application, comme les véhicules utilitaires de la catégorie N 1, et de contrôler d'autres aspects du transport et de la sécurité routière.

SYSTÈME DE PROTECTION DE L'ESPACE DE CHARGEMENT ET DE FIXATION DU CHARGEMENT

Le nouveau système de protection intégré pour fourgons conçu par Store Van respecte les lignes directrices de la nouvelle directive 2014/47/EU et garantit une **fixation flexible et sûre** du chargement aux planchers et aux parois du véhicule.

En utilisant les composants d'accrochage « Airline » et grâce à l'adoption de nombreux accessoires tels que des sangles, des filets et des barres télescopiques, l'utilisateur du véhicule peut aménager sa plateforme d'accrochage de manière simple, économique et conforme à la directive européenne.

Le système prévoit l'utilisation:

- de planchers pour fourgons en multiplis avec résine phénolique prééquipés pour les arrimages d'origine du véhicule et les arrimages supplémentaires (page 10) au ras du plancher avec une traction de 200 daN ;
- de barres en aluminium « Airline » fixées au châssis (page 11) ;
- de panneaux en polypropylène très flexibles et résistants pour protéger l'intérieur de la carrosserie contre les chocs accidentels (page 8).

L'APPLICATION DU NOUVEAU KIT DE PROTECTION GARANTIT TOUTE UNE SÉRIE D'AVANTAGES:

- l'utilisateur du véhicule peut déjà fixer, de manière sûre, le chargement aux barres « Airline », grâce aux sangles d'arrimage;
- le kit de fixation intégré permet de conserver la carrosserie en bon état plus longtemps ;
- le système de protection confère au véhicule de la valeur ajoutée, une qualité très importante sur le marché du neuf et fondamentale pour celui de l'occasion, généralement mis à mal par les fréquents dommages.

SAFETY CROSS: punti di fissaggio longitudinali e trasversali su richiesta
SAFETY CROSS: points de fixation longitudinaux et transversaux sur demande

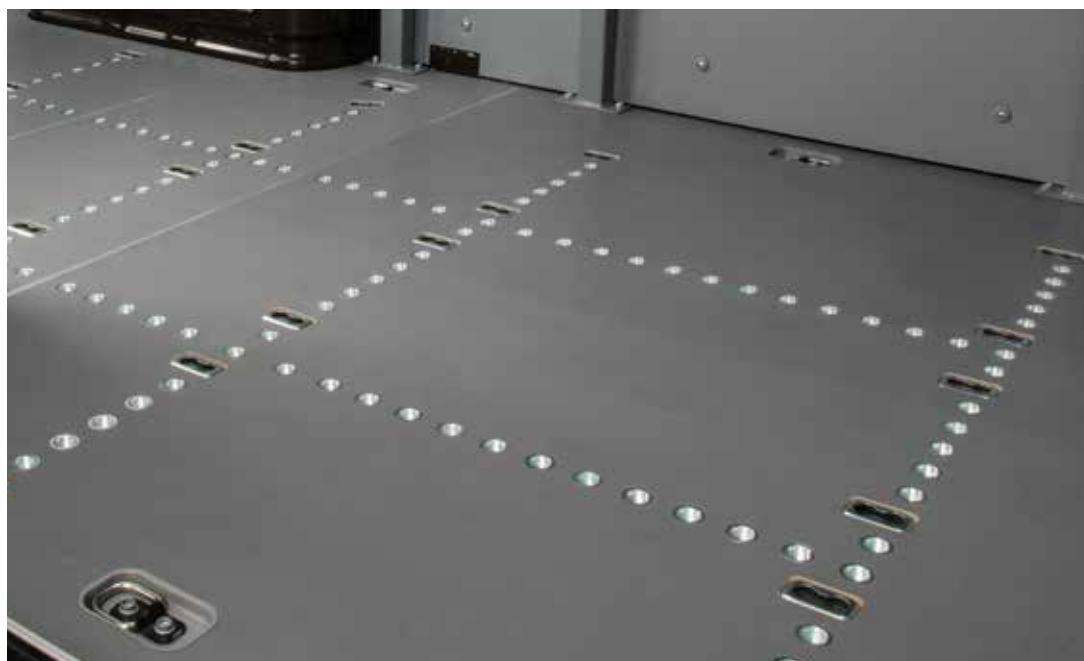

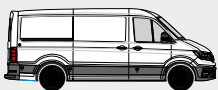

- Pannellature per veicolo con porta laterale destra e pareti lamierate.
- Habillages pour véhicule avec porte latérale droite et parois en tôle.

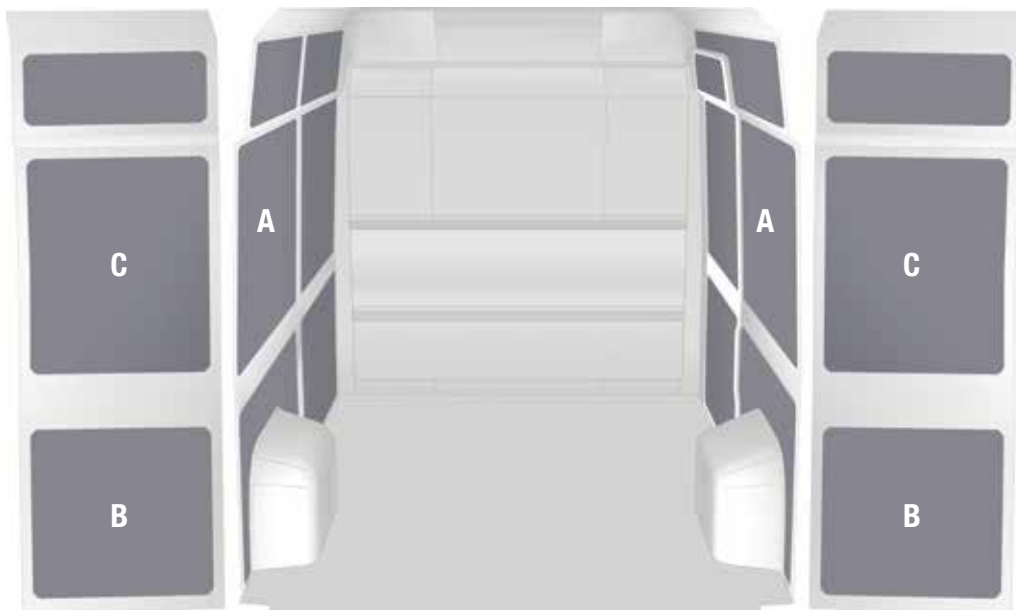

HONEYCOMB PANEL - A

- Pannellatura in polipropilene per:
 - parete laterale sinistra
 - parete laterale destra e porta scorrevole
- Habillage en polypropylène pour:
 - paroi latérale gauche
 - paroi latérale droite et porte coulissante

HONEYCOMB PANEL - B

- Pannellatura in polipropilene per:
 - parte inferiore delle porte posteriori a battente
- Habillage en polypropylène pour:
 - partie inférieure des portes arrière battantes

HONEYCOMB PANEL - C

- Pannellatura in polipropilene per:
 - parte superiore delle porte posteriori a battente
- Habillage en polypropylène pour:
 - partie supérieure des portes arrière battantes

VEICOLO VÉHICULE	PANNELLATURA HABILLAGE	
	A+B ART.	C ART.
Modello - Modèle Standard, tetto normale - Standard, toit standard	CR 30H2 A0 18,34 kg	CR DRH2 A0 1,85 kg
Modello - Modèle Standard, tetto alto - Standard, toit haut	CR 30H3 A0 21,21 kg	CR DRH3 A0 2,95 kg
Modello - Modèle Lungo, tetto alto - Long, toit haut	CR 40H3 A0 27,34 kg	CR DRH3 A0 2,95 kg
Modello - Modèle Super lungo, tetto alto - Extra-long, toit haut	CR 4LH3 A0 31,34 kg	CR DRH3 A0 2,95 kg



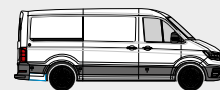

- Pianale per veicolo con porta laterale destra e pareti lamierate.
- Plancher pour véhicule avec porte latérale droite et parois en tôle.

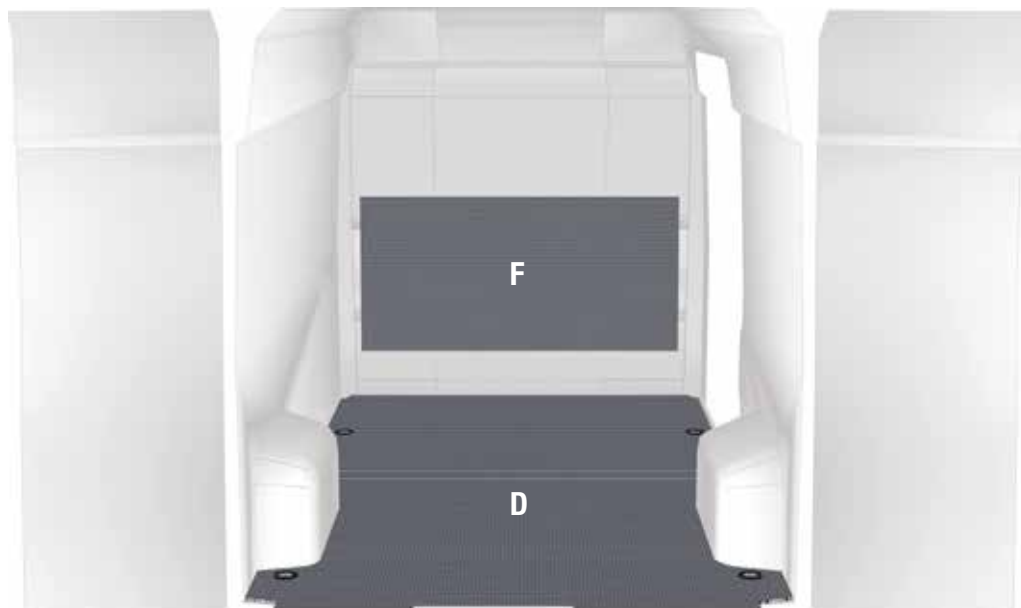

WOOD FLOOR - D

- Pianale in legno spessore 9/12 mm con rivestimento fenolico e predisposizione per gli ancoraggi originali del veicolo
- Plancher en bois de 9/12 mm avec revêtement phénolique et équipé pour les ancrages originaux du véhicule

WOOD FLOOR - F

- Pannello retrocabina in legno spessore 12 mm con rivestimento fenolico
- Panneau arrière cabine en bois de 12 mm d'épaisseur avec revêtement phénolique

FURGONE LAMIERATO - FOURGON TÔLE
MAN TGE

WF

VEICOLO VÉHICULE	PIANALE 9 mm PLANCHER 9 mm	PIANALE 12 mm PLANCHER 12 mm	RETROCABINA ARRIÈRE CABINE
	D	D	F (1500x650x12 mm)
	ART.	ART.	ART.
Modello - Modèle Standard - Standard	CR 30D1 A0 37,64 kg	CR 30T1 A0 46,61 kg	CR WBT1 A0 8,40 kg
Modello - Modèle Lungo - Long	CR 40D1 A0 47,84 kg	CR 40T1 A0 59,85 kg	CR WBT1 A0 8,40 kg
Modello - Modèle Super lungo - Extra-long	CR 4LD1 A0 54,80 kg	CR 4LT1 A0 67,99 kg	CR WBT1 A0 8,40 kg



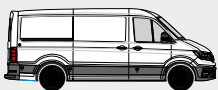

- Pianale per veicolo con porta laterale destra e pareti lamierate.
- Plancher pour véhicule avec porte latérale droite et parois en tôle.

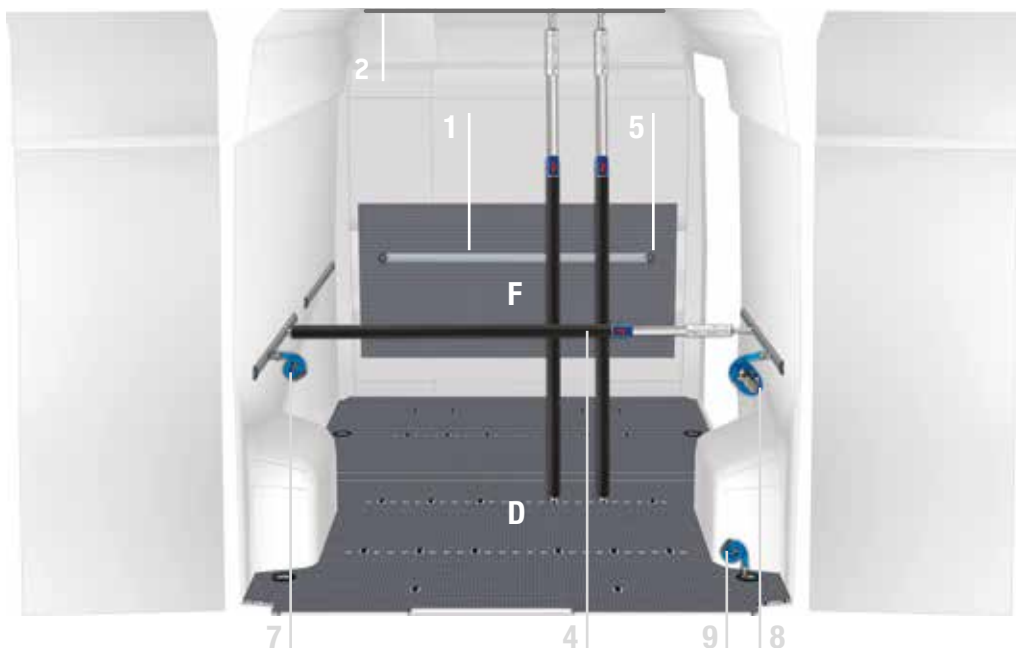

SAFETY FLOOR - D

- Pianale in legno spessore 9 mm con rivestimento fenolico e sistema di ancoraggio aggiuntivo
- Plancher 9 mm en bois avec revêtement phénolique et points d'ancrage supplémentaires

WOOD FLOOR - F

- Pannello retrocabina in legno spessore 12 mm con rivestimento fenolico
- Panneau arrière cabine en bois de 12 mm d'épaisseur avec revêtement phénolique

VEICOLO VÉHICULE	PIANALE 9 mm PLANCHER 9 mm	RETROCABINA ARRIÈRE CABINE
	D	F (1500x650x12 mm)
	ART.	ART.
Modello - Modèle Standard - Standard	CR 30G1 A0 43,10 kg	CR WBT1 A0 8,40 kg
Modello - Modèle Lungo - Long	CR 40G1 A0 55,16 kg	CR WBT1 A0 8,40 kg
Modello - Modèle Super lungo - Extra-long	CR 4LG1 A0 62,19 kg	CR WBT1 A0 8,40 kg

Il pianale deve essere incollato al veicolo
Le plancher doit être collé au véhicule



- Colla siliconica per pianali.
- Colle en silicone pour planchers.

ART. **V22585**



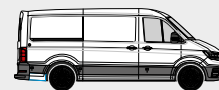

- Barra orizzontale in alluminio.
- Barre horizontale en aluminium.

1

ART.

- V18029 05 Lunghezza - Longueur 500 mm
- V18029 10 Lunghezza - Longueur 1000 mm
- V18029 15 Lunghezza - Longueur 1500 mm
- V18029 20 Lunghezza - Longueur 2000 mm
- V18029 25 Lunghezza - Longueur 2500 mm



- Barra orizzontale in alluminio.
- Barre horizontale en aluminium.

2

ART.

- V18025 05 Lunghezza - Longueur 500 mm
- V18025 10 Lunghezza - Longueur 1000 mm
- V18025 15 Lunghezza - Longueur 1500 mm
- V18025 20 Lunghezza - Longueur 2000 mm



- Barra orizzontale in alluminio.
- Barre horizontale en aluminium.

3

ART.

- V18030 10 Lunghezza - Longueur 1000 mm
- V18030 15 Lunghezza - Longueur 1500 mm
- V18030 20 Lunghezza - Longueur 2000 mm
- V18030 25 Lunghezza - Longueur 2500 mm
- V18030 30 Lunghezza - Longueur 3000 mm



- Barra telescopica fermacarico.
- Barre télescopique d'arrimage.

4

ART.

- V22149 Lunghezza - Longueur 650-900 mm
- V22734 Lunghezza - Longueur 850-1100 mm
- V22735 Lunghezza - Longueur 1050-1300 mm
- V22131 Lunghezza - Longueur 1250-1750 mm
- V22017 Lunghezza - Longueur 1550-2050 mm
- V22086 Lunghezza - Longueur 2000-2500 mm



- Finale in plastica per barra serie V18029.
- Bouchon en plastique pour barre série V18029.

5

ART.

V22106



- Anello fermacarico.
- Anneau d'arrimage.

6

ART.

V225820



- Cinghia fermacarico con morsetto 2500+500.
- Sangle d'arrimage avec crochet 2500+500.

7

ART.

V22136



- Cinghia fermacarico con cricchetto 2280+420.
- Sangle d'arrimage à cliquet 2280+420.

8

ART.

V22124



- Cinghia fermacarico con cricchetto 4500+500.
- Sangle d'arrimage à cliquet 4500+500.

9

ART.

V22148



- Esempio valigetta per il fissaggio del carico.
- Exemple de mallette pour sécurisation du chargement.



1 ART.
BOX080

L=440 P=350 H=80 mm



2 ART.
V22136



2 ART.
V22124



1 ART.
CPV080



2 ART.
V22148



4 ART.
V225820



1 ART.
YELLOW



LEGENDA PANNELLATURE - LÉGENDE HABILLAGES

MAN TGE

FURGONE LAMIERATO - FOURGON TÔLÉ

HP HONEYCOMB PANEL

- Per veicolo con porta laterale destra e pareti lamierate.
- Pour véhicule avec porte latérale droite et parois en tôle.

Modello - Modèle

Standard, tetto normale - Standard, toit standard

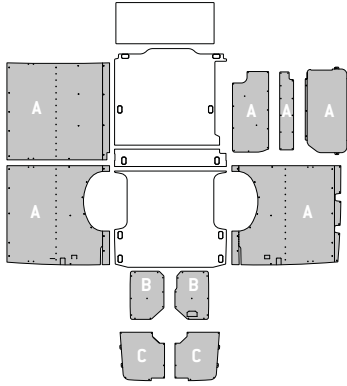

Modello - Modèle

Standard, tetto alto - Standard, toit haut

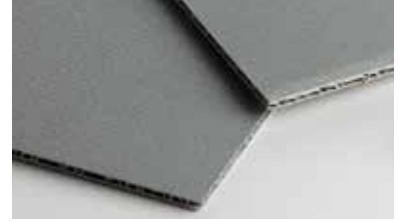
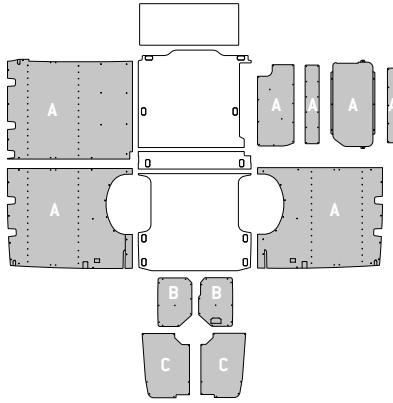

Modello - Modèle

Lungo, tetto alto - Long, toit haut

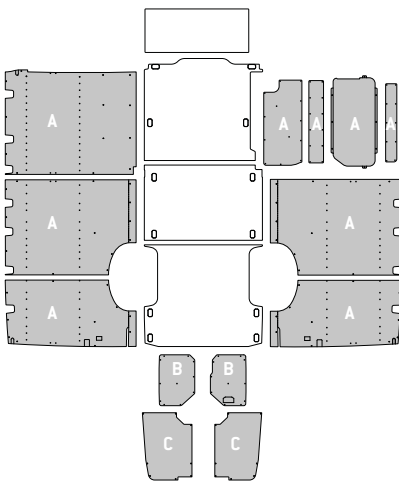

Modello - Modèle

Super lungo, tetto alto - Extra-long, toit haut

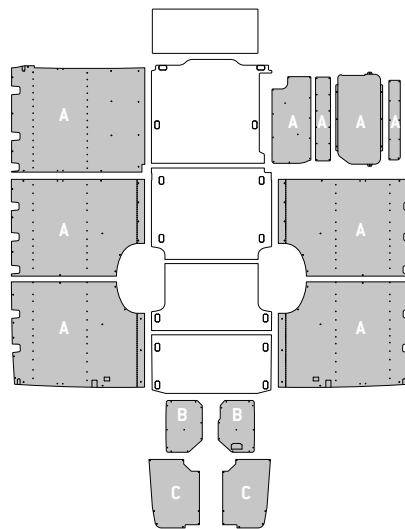

SAFETY CROSS: punti di fissaggio longitudinali e trasversali su richiesta

SAFETY CROSS: points de fixation longitudinaux et transversaux sur demande

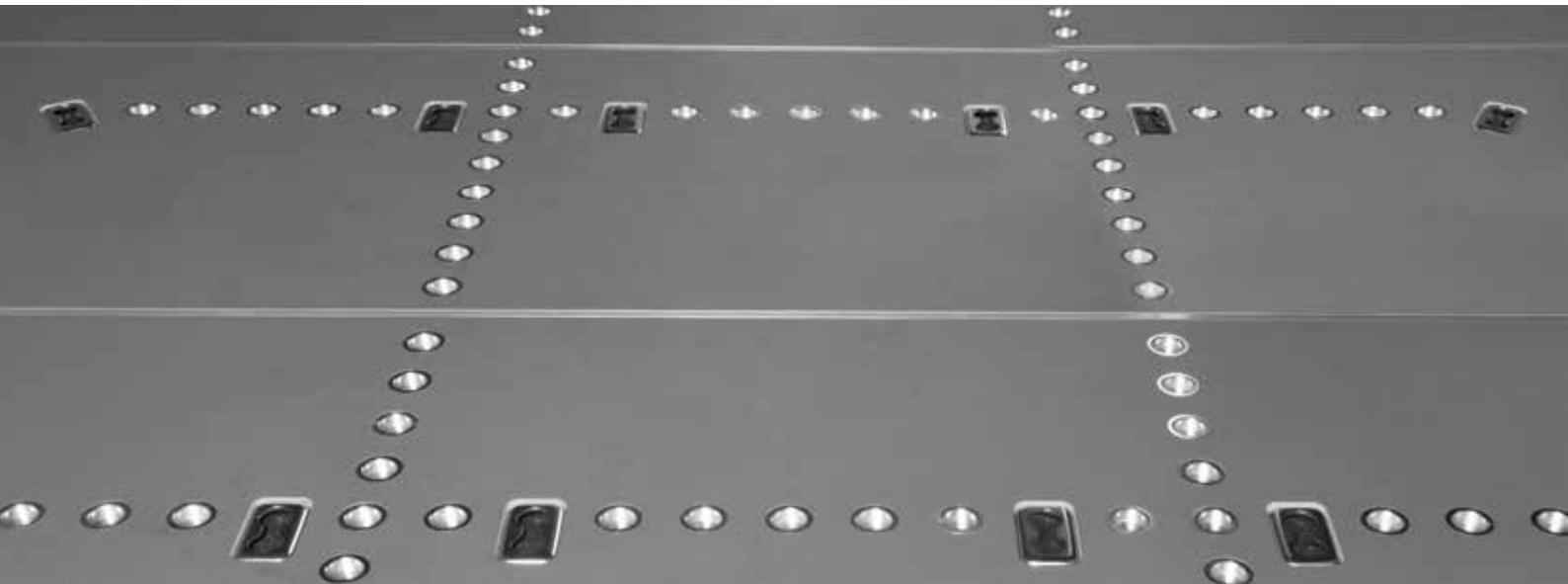

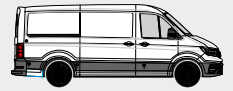

- Per veicolo con porta laterale destra e pareti lamierate.
- Pour véhicule avec porte latérale droite et parois en tôle.

Modello - Modèle Standard - Standard	Modello - Modèle Lungo - Long	Modello - Modèle Super lungo - Extra-long

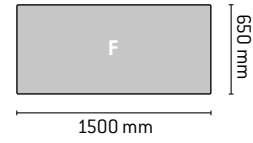

- Pannello retrocabina
- Panneau arrière cabine

FURGONE LAMIERATO - FOURGON TÔLE
MAN TGE

WOOD FLOOR
WF

- Per veicolo con porta laterale destra e pareti lamierate.
- Pour véhicule avec porte latérale droite et parois en tôle.

Modello - Modèle Standard - Standard	Modello - Modèle Lungo - Long	Modello - Modèle Super lungo - Extra-long



- Per ogni pianale, ogni fila di fissaggi è composta da 6 punti di ancoraggio "Airline" e 19 punti di fissaggio per pali "Airline".
- Sur chaque plancher, chaque rangée d'arrimages se compose de 6 points d'ancrage "Airline" et 19 points de fixation pour barres d'arrimage "Airline".

SAFETY FLOOR
SF



**Il fissaggio del carico
è di serie**

La fixation du
chargement de série

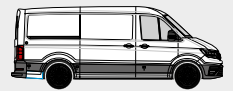

La soluzione d'**allestimento per furgoni SAFETY** di Store Van nasce per soddisfare i requisiti delle nuove disposizioni sulla sicurezza del carico. Nei moduli vengono integrati elementi strutturali che permettono l'utilizzo di sistemi di trattenuta "Airline", quali cinghie, reti e pali telescopici. Questo nuovo livello di **allestimento per veicoli commerciali** facilita l'ancoraggio di oggetti medio piccoli anche in presenza di pianali per furgoni privi di sistemi di ancoraggio, garantendo così la sicurezza del carico. Gli elementi di ancoraggio "Airline" del livello SAFETY aumentano la stabilità del modulo senza maggiorarne il peso in quanto integrati nella struttura stessa dell'allestimento.

La solution d'**aménagement pour fourgons SAFETY** de Store Van a été conçue pour répondre aux exigences des nouvelles dispositions en matière de sécurité du chargement. Dans les modules, les éléments structurels intégrés permettent d'utiliser des systèmes de maintien « Airline », tels que des sangles, des filets et des barres télescopiques. Ce nouveau niveau d'**aménagement pour véhicules utilitaires** facilite l'arrimage d'objets moyens et petits, même en cas de planchers pour fourgons sans systèmes d'arrimage, ce qui garantit la sécurité du chargement. Les éléments d'arrimage « Airline » du niveau SAFETY améliorent la stabilité du module sans augmenter son poids car ils sont intégrés dans la structure même de l'aménagement.





Standard, tetto normale - Standard, toit standard

MAN TGE
FURGONE LAMIERATO - FOURGON TÔLÉ

SAFETY

ESEMPIO DI ALLESTIMENTO - EXEMPLES D'AMÉNAGEMENTS

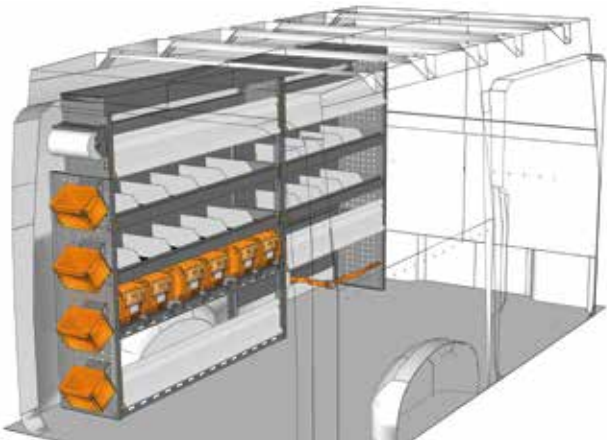

ESEMPIO - EXEMPLE

CR 2716 01*

L=2749 P=365 H=1590 mm

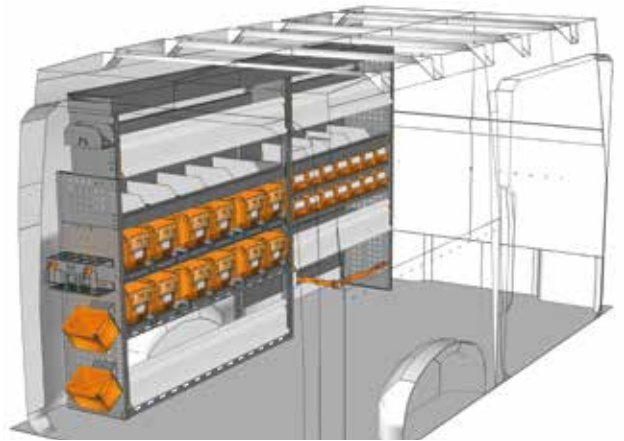

ESEMPIO - EXEMPLE

CR 2716 02*

L=2749 P=365 H=1590 mm

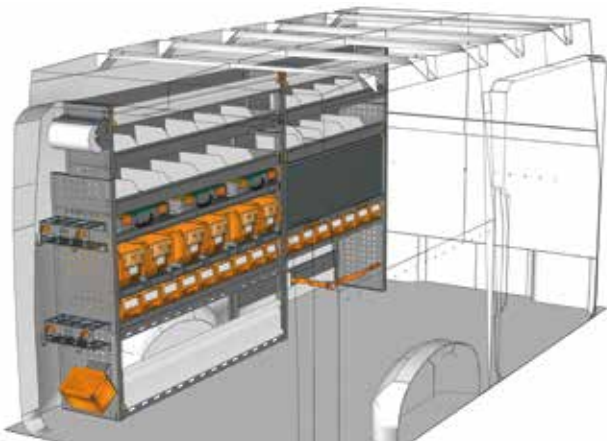

ESEMPIO - EXEMPLE

CR 2716 03*

L=2749 P=365 H=1550 mm

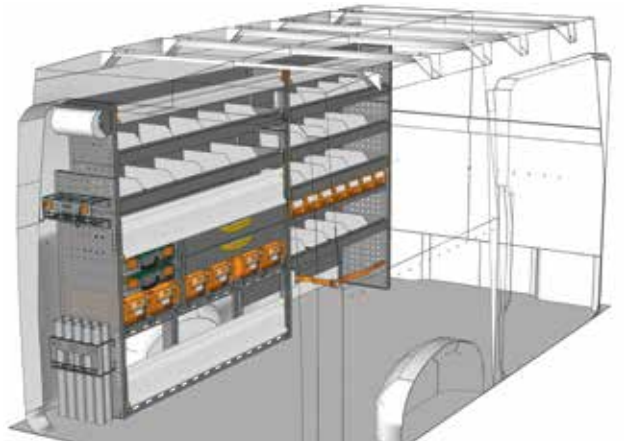

ESEMPIO - EXEMPLE

CR 2716 04*

L=2749 P=365 H=1550 mm

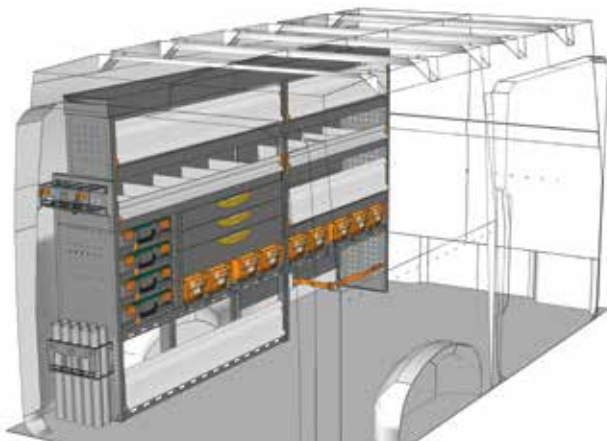

ESEMPIO - EXEMPLE

CR 2716 05*

L=2749 P=365 H=1590 mm

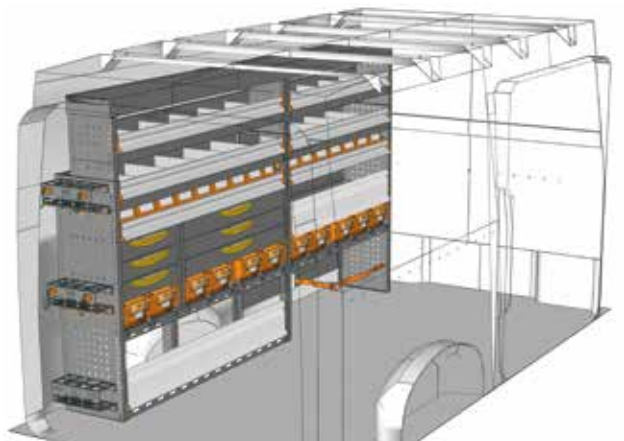
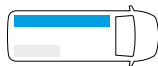

ESEMPIO - EXEMPLE

CR 2716 06*

L=2749 P=365 H=1590 mm

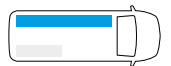

* Kit fissaggio incluso - Jeu de fixation inclus

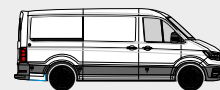

ESEMPI DI ALLESTIMENTO - EXEMPLES D'AMÉNAGEMENTS

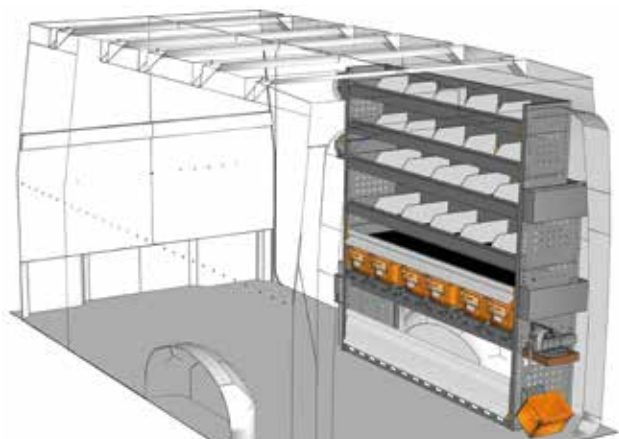

ESEMPIO - EXEMPLE

CR 1516 01*

L=1524 P=365 H=1600 mm

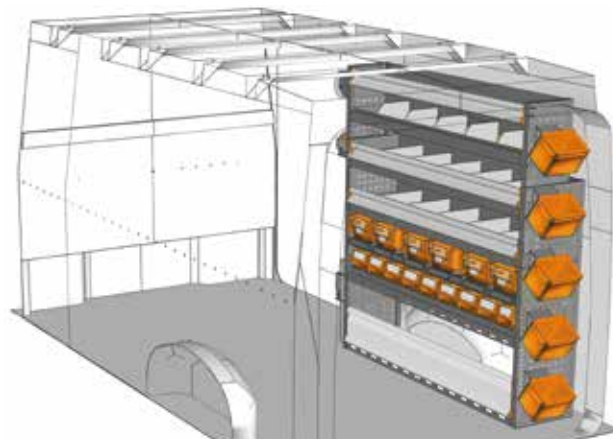
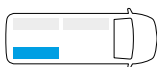

ESEMPIO - EXEMPLE

CR 1516 02*

L=1524 P=365 H=1600 mm

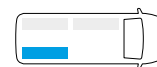

Vista da porta laterale
Vue de porte latérale

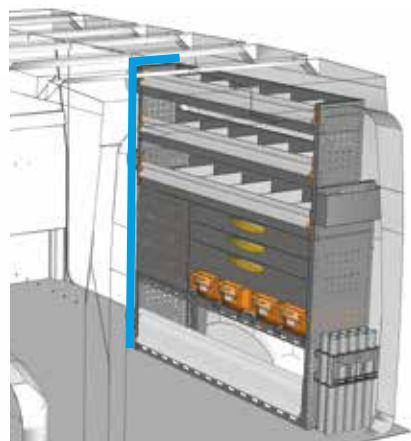

ESEMPIO - EXEMPLE

CR 1516 03*

L=1524 P=365 H=1600 mm

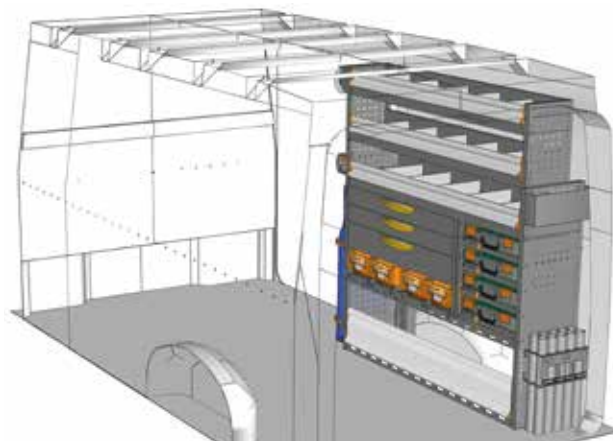

ESEMPIO - EXEMPLE

CR 1516 04*

L=1524 P=365 H=1600 mm

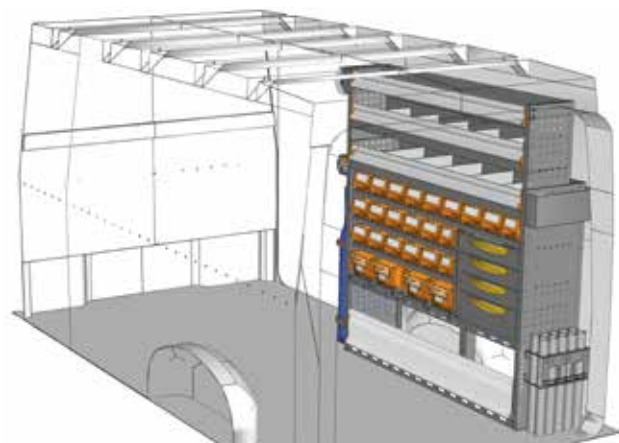

ESEMPIO - EXEMPLE

CR 1516 05*

L=1524 P=365 H=1600 mm

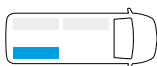

Non hai trovato il tuo allestimento?
Affidati ai nostri professionisti
Guarda il retro di questo catalogo e
contatta il punto Store Van piu vicino
oppure visita il nostro sito.

**Vous n'avez pas trouvé votre
équipement ? Confiez-vous
à nos professionnels**
Voir au dos de ce catalogue
et contactez le point StoreVan
le plus proche ou visitez notre site web.



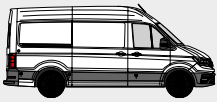

Standard, tetto alto - Standard, toit haut

MAN TGE
FURGONE LAMIERATO - FOURGON TÔLÉ

SAFETY

ESEMPIO DI ALLESTIMENTO - EXEMPLES D'AMÉNAGEMENTS

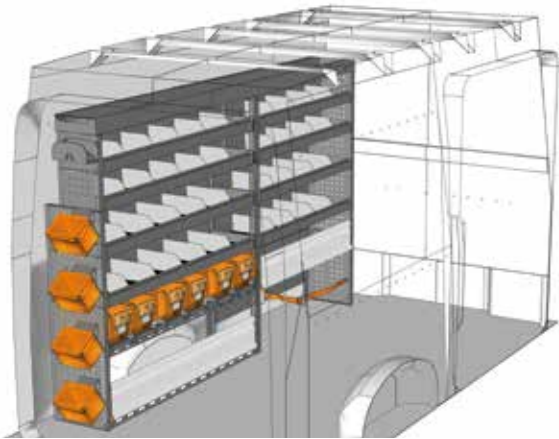

ESEMPIO - EXEMPLE

CR 2717 01*

L=2749 P=365 H=1690 mm

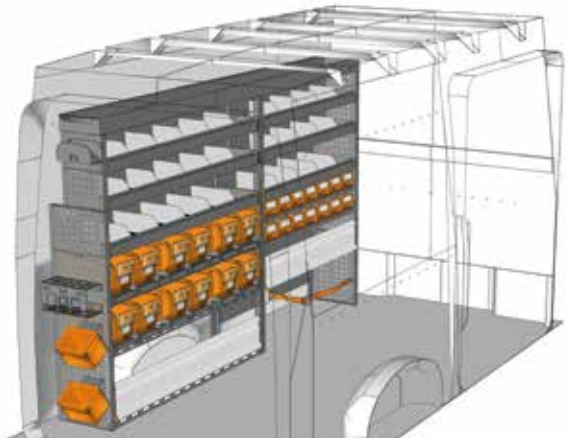

ESEMPIO - EXEMPLE

CR 2717 02*

L=2749 P=365 H=1690 mm

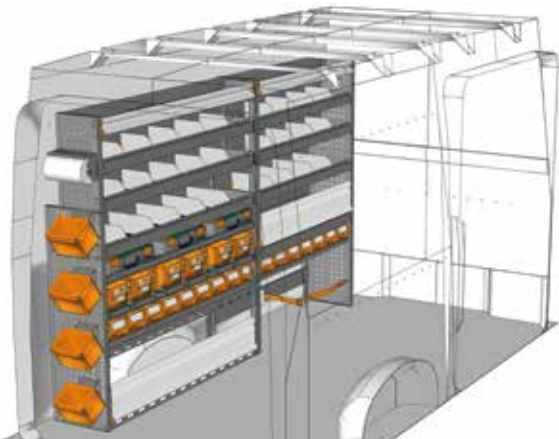

ESEMPIO - EXEMPLE

CR 2717 03*

L=2749 P=365 H=1700 mm

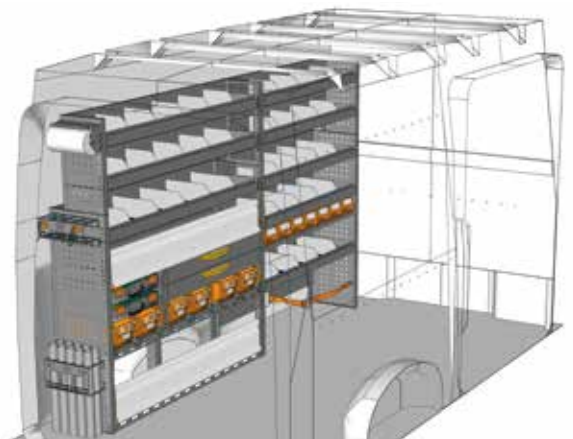

ESEMPIO - EXEMPLE

CR 2717 04*

L=2749 P=365 H=1700 mm

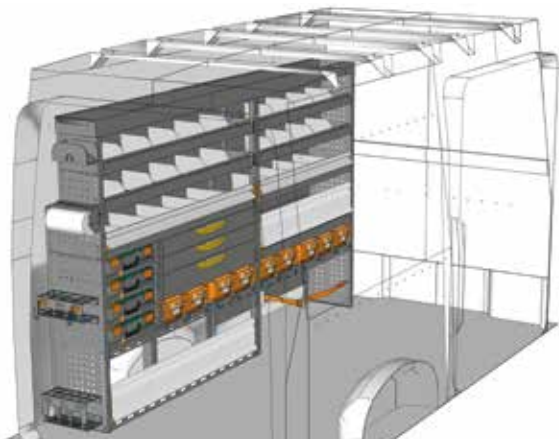

ESEMPIO - EXEMPLE

CR 2717 05*

L=2749 P=365 H=1690 mm

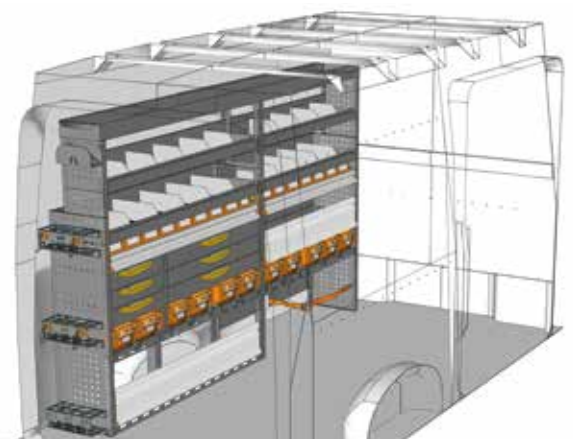

ESEMPIO - EXEMPLE

CR 2717 06*

L=2749 P=365 H=1690 mm

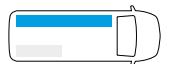

* Kit fissaggio incluso - Jeu de fixation inclus

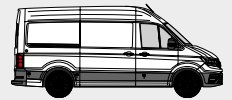

ESEMPIO DI ALLESTIMENTO - EXEMPLES D'AMÉNAGEMENTS



ESEMPIO - EXEMPLE

CR 1517 01*

L=1524 P=365 H=1700 mm

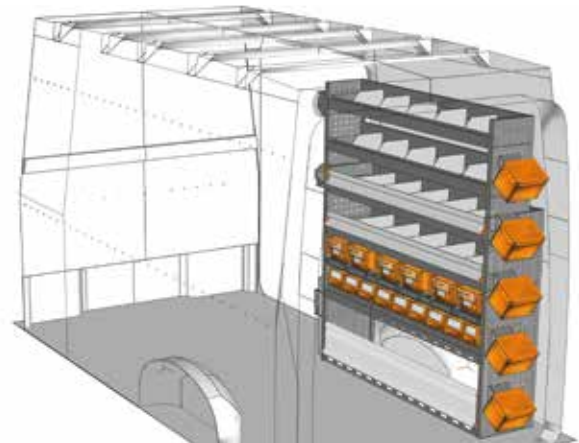
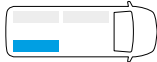

ESEMPIO - EXEMPLE

CR 1517 02*

L=1524 P=365 H=1700 mm

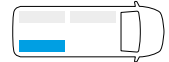

Vista da porta laterale
Vue de porte latérale

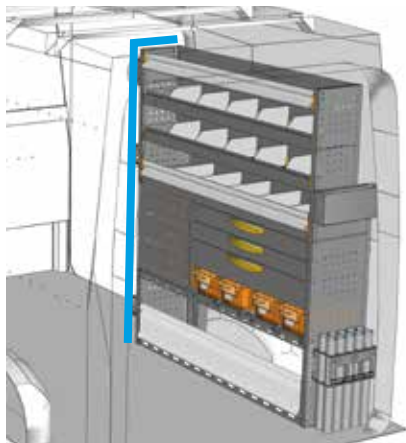

ESEMPIO - EXEMPLE

CR 1517 03*

L=1524 P=365 H=1700 mm

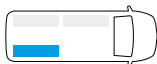

ESEMPIO - EXEMPLE

CR 1517 04*

L=1524 P=365 H=1700 mm

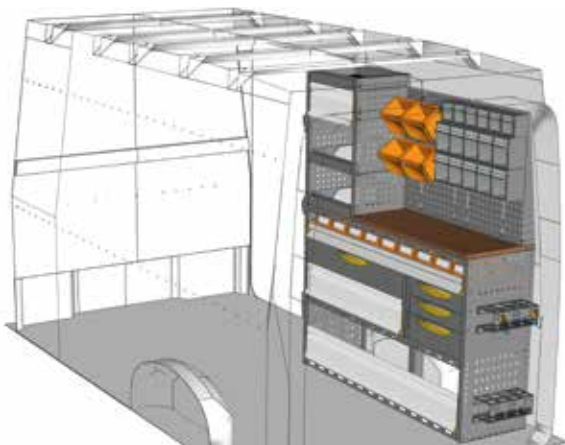
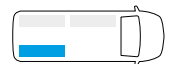

ESEMPIO - EXEMPLE

CR 1517 05*

L=1524 P=445 H=1800 mm

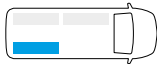

Non hai trovato il tuo allestimento?

Affidati ai nostri professionisti

Guarda il retro di questo catalogo e
contatta il punto Store Van piu vicino
oppure visita il nostro sito.

**Vous n'avez pas trouvé votre
équipement ? Confiez-vous
à nos professionnels**

Voir au dos de ce catalogue
et contactez le point StoreVan
le plus proche ou visitez notre site web.



* Kit fissaggio incluso - Jeu de fixation inclus

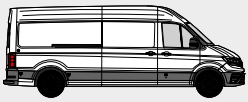

Lungo, tetto alto - Long, toit haut

MAN TGE
FURGONE LAMIERATO - FOURGON TÔLÉ

SAFETY

ESEMPIO DI ALLESTIMENTO - EXEMPLES D'AMÉNAGEMENTS

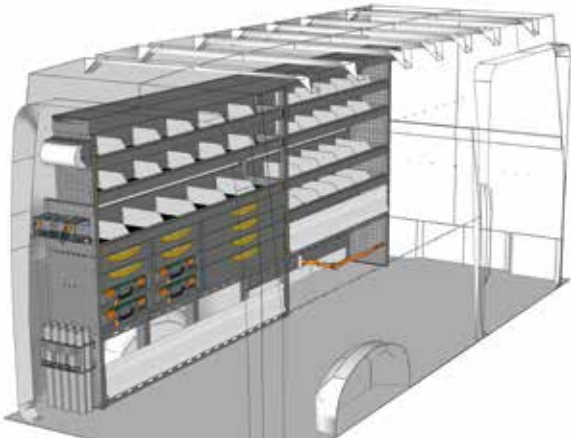

ESEMPIO - EXEMPLE

CR 3717 01*

L=3708 P=365 H=1690 mm

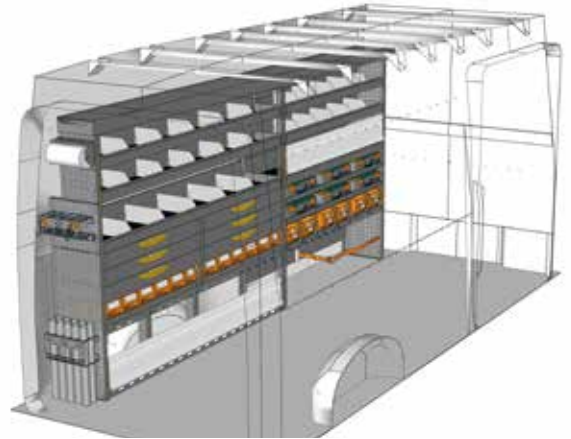

ESEMPIO - EXEMPLE

CR 3717 02*

L=3708 P=365 H=1690 mm

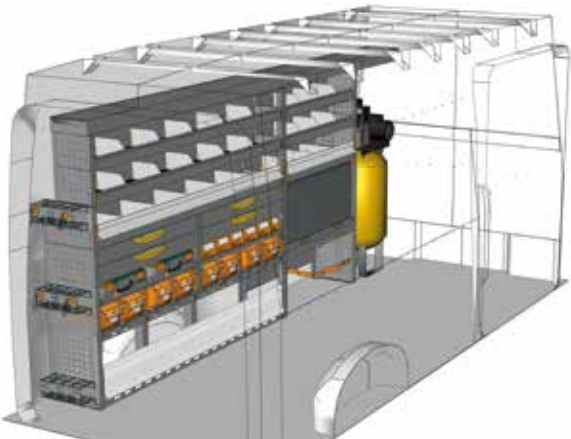

ESEMPIO - EXEMPLE

CR 3717 03*

L=3708 P=365 H=1690 mm

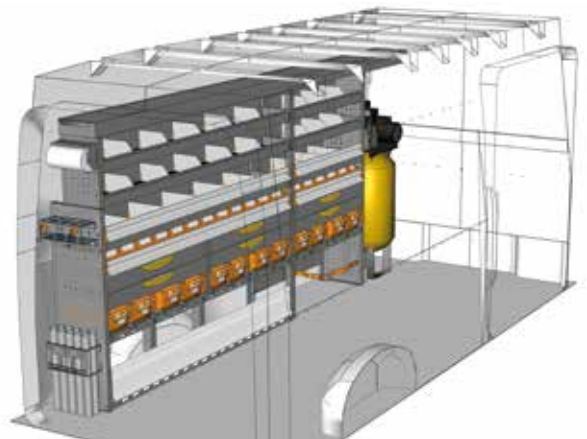

ESEMPIO - EXEMPLE

CR 3717 04*

L=3708 P=365 H=1690 mm

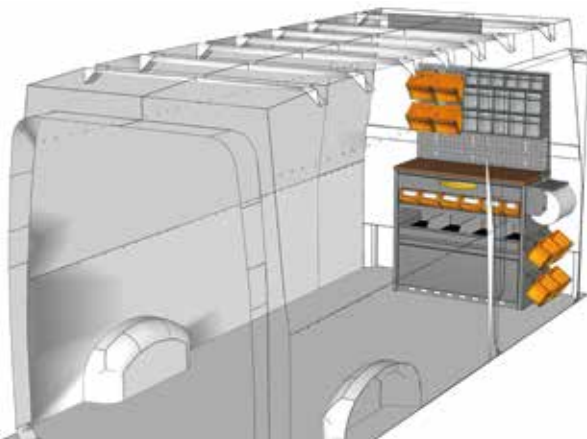

ESEMPIO - EXEMPLE

CR 1016 01*

L=1010 P=445 H=1625 mm

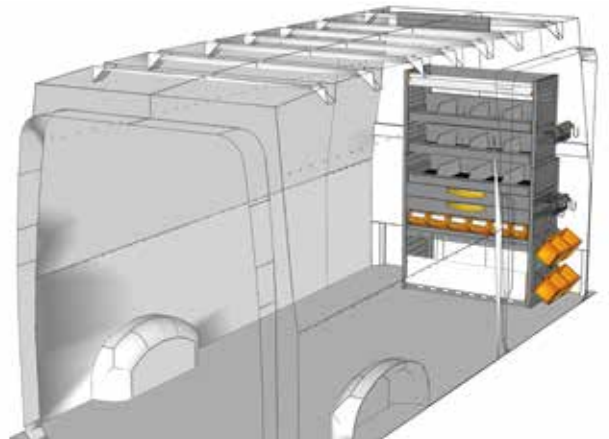

ESEMPIO - EXEMPLE

CR 1016 02*

L=1010 P=445 H=1600 mm



* Kit fissaggio incluso - Jeu de fixation inclus

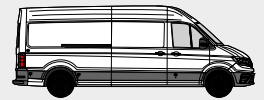

ESEMPI DI ALLESTIMENTO - EXEMPLES D'AMÉNAGEMENTS

FURGONE LAMIERATO - FOURGON TÔLE
MAN TGE

SAFETY

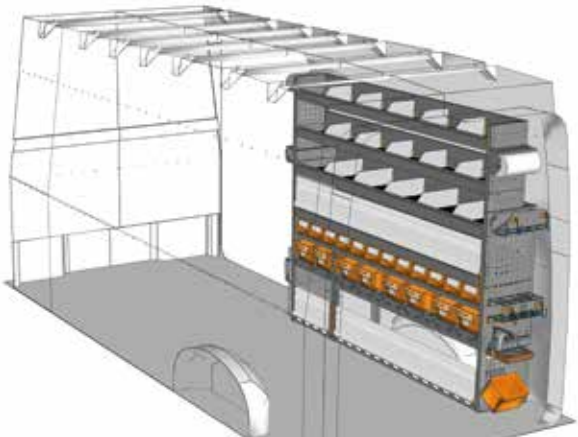

ESEMPIO - EXEMPLE

CR 2017 01*

L=2032 P=365 H=1700 mm

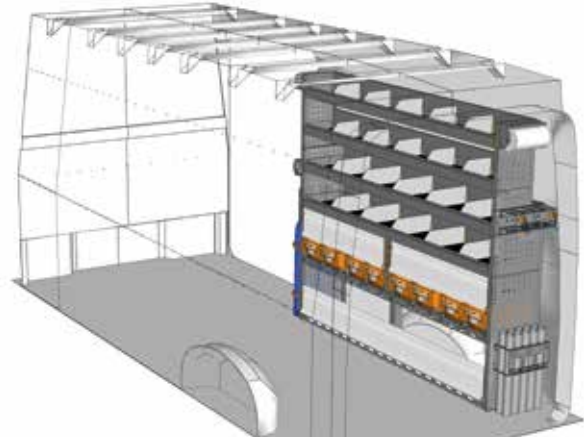
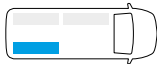

ESEMPIO - EXEMPLE

CR 2017 02*

L=2032 P=365 H=1700 mm

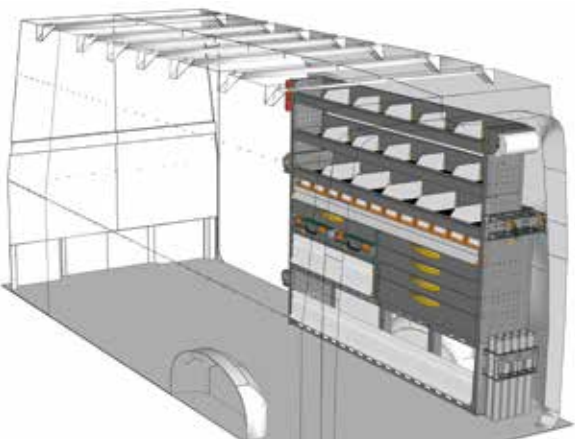
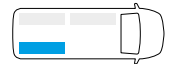

ESEMPIO - EXEMPLE

CR 2017 03*

L=2032 P=365 H=1700 mm

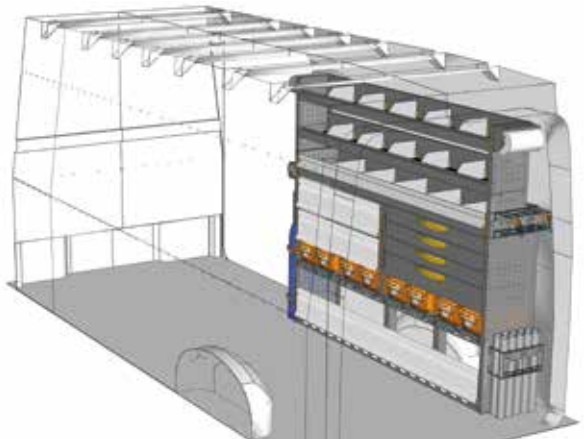
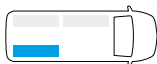

ESEMPIO - EXEMPLE

CR 2017 04*

L=2032 P=365 H=1700 mm

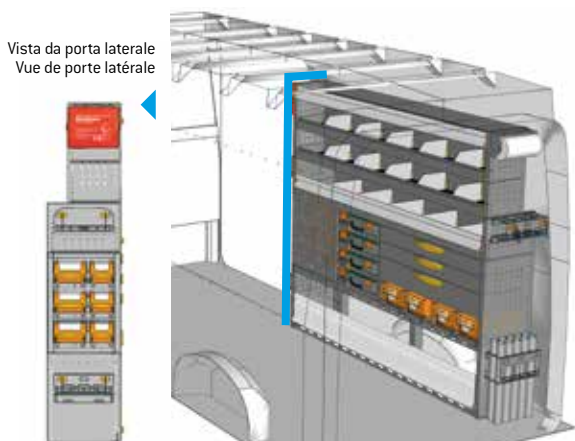
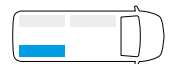

ESEMPIO - EXEMPLE

CR 2017 05*

L=2032 P=365 H=1700 mm

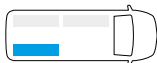

Non hai trovato il tuo allestimento?
Affidati ai nostri professionisti
Guarda il retro di questo catalogo e
contatta il punto Store Van piu vicino
oppure visita il nostro sito.

**Vous n'avez pas trouvé votre
équipement ? Confiez-vous
à nos professionnels**
Voir au dos de ce catalogue
et contactez le point StoreVan
le plus proche ou visitez notre site web.



* Kit fissaggio incluso - Jeu de fixation inclus

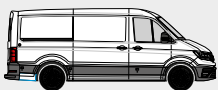

**L'integrazione perfetta
tra veicolo e allestimento
officina mobile**

L'intégration parfaite
entre le véhicule et
l'aménagement de
l'atelier mobile

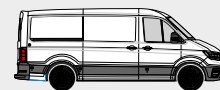

L'allestimento per furgoni PROFESSIONAL progettato da Store Van è integrato perfettamente nel veicolo ed è studiato appositamente per esaltarne le caratteristiche strutturali e dinamiche. I moduli di questo nuovo livello di **allestimento per veicolo commerciale**, come le scaffalature per furgoni, integrano, di serie, elementi per un perfetto fissaggio del carico al telaio del veicolo mediante l'utilizzo dei sistemi di trattenuta "Airline". Sono disponibili sistemi di trattenuta del carico verticali e orizzontali grazie al nuovo pianale SAFETY FLOOR.

L'aménagement pour fourgons PROFESSIONAL conçu par Store Van est parfaitement intégré au véhicule et a été spécialement étudié pour en optimiser les caractéristiques structurelles et dynamiques. Les modules de ce nouveau niveau d'**aménagement pour véhicule utilitaire**, comme les rayonnages pour fourgons, comprennent, de série, des éléments conçus pour une fixation parfaite du chargement au châssis du véhicule grâce à l'utilisation des systèmes de maintien « Airline ». Des systèmes de maintien du chargement verticaux et horizontaux sont disponibles grâce au nouveau plancher SAFETY FLOOR.





Standard, tetto normale - Standard, toit standard

MAN TGE
FURGONE LAMIERATO - FOURGON TÔLÉ
PROFESSIONAL

ESEMPI DI ALLESTIMENTO - EXEMPLES D'AMÉNAGEMENTS

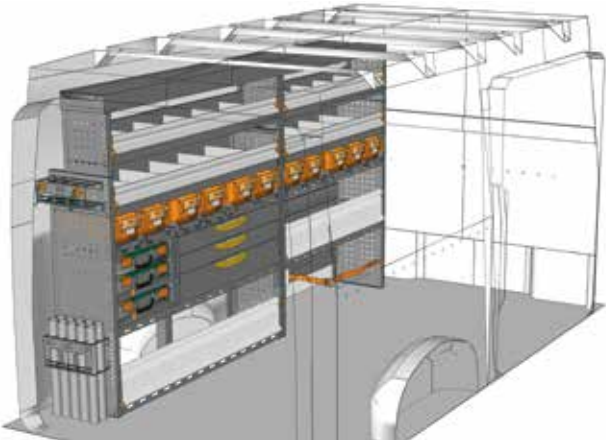

ESEMPIO - EXEMPLE

CR 2716 P1*

L=2749 P=365 H=1590 mm

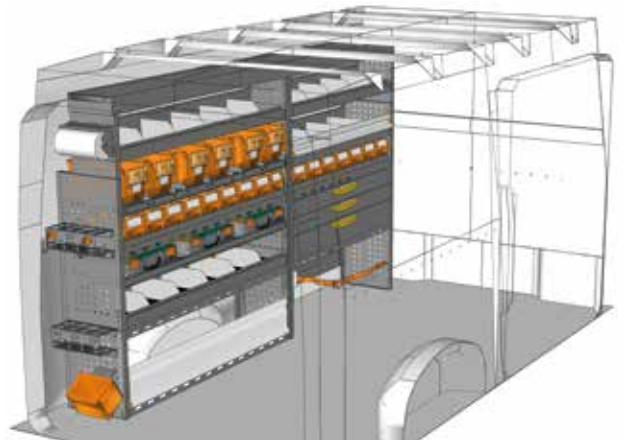
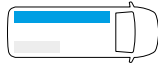

ESEMPIO - EXEMPLE

CR 2716 P2*

L=2749 P=365 H=1590 mm

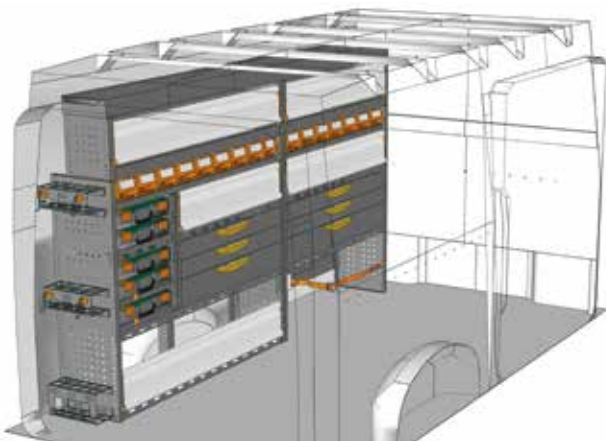
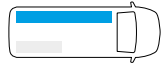

ESEMPIO - EXEMPLE

CR 2716 P3*

L=2749 P=365 H=1590 mm

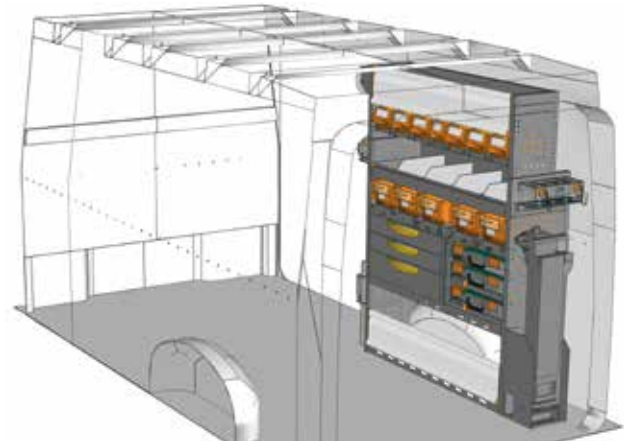
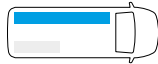

ESEMPIO - EXEMPLE

CR 1216 P1*

L=1225 P=365 H=1600 mm

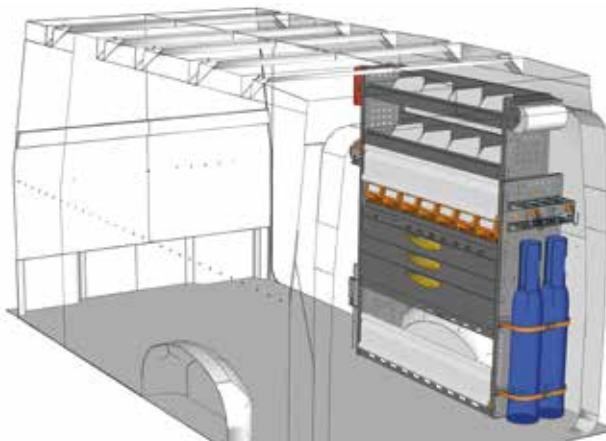
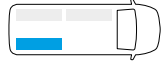

ESEMPIO - EXEMPLE

CR 1216 P2*

L=1225 P=365 H=1600 mm

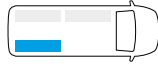

ESEMPIO - EXEMPLE

CR 1216 P3*

L=1225 P=365 H=1600 mm

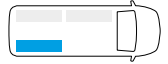

* Kit fissaggio incluso - Jeu de fixation inclus

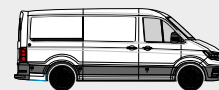

ESEMPI DI ALLESTIMENTO - EXEMPLES D'AMÉNAGEMENTS

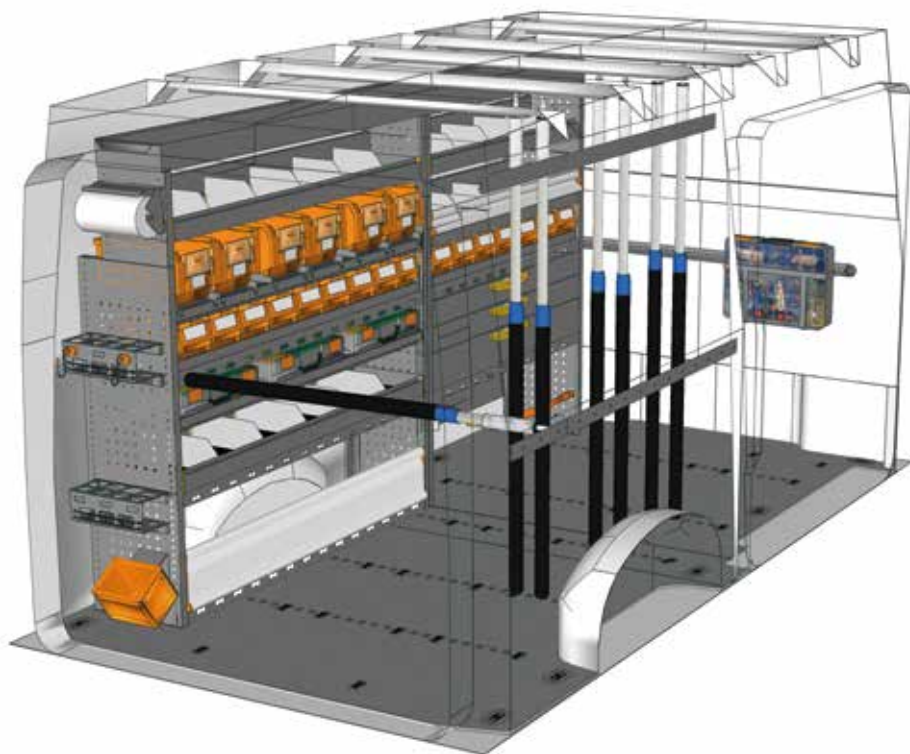

ESEMPIO - EXEMPLE

EXAMPLE CR L3H2 P1*



- | | |
|----------------|-------------|
| 1 x CR 2716 P2 | 1 x CPV080 |
| 1 x CR 30G1 A0 | 2 x V22136 |
| 1 x V22585 | 2 x V22124 |
| 7 x V22131 | 2 x V22148 |
| 3 x V18029 15 | 1 x YELLOW |
| 2 x V22106 | 4 x V225820 |
| 5 x V18025 15 | |
| 1 x BOX080 | |

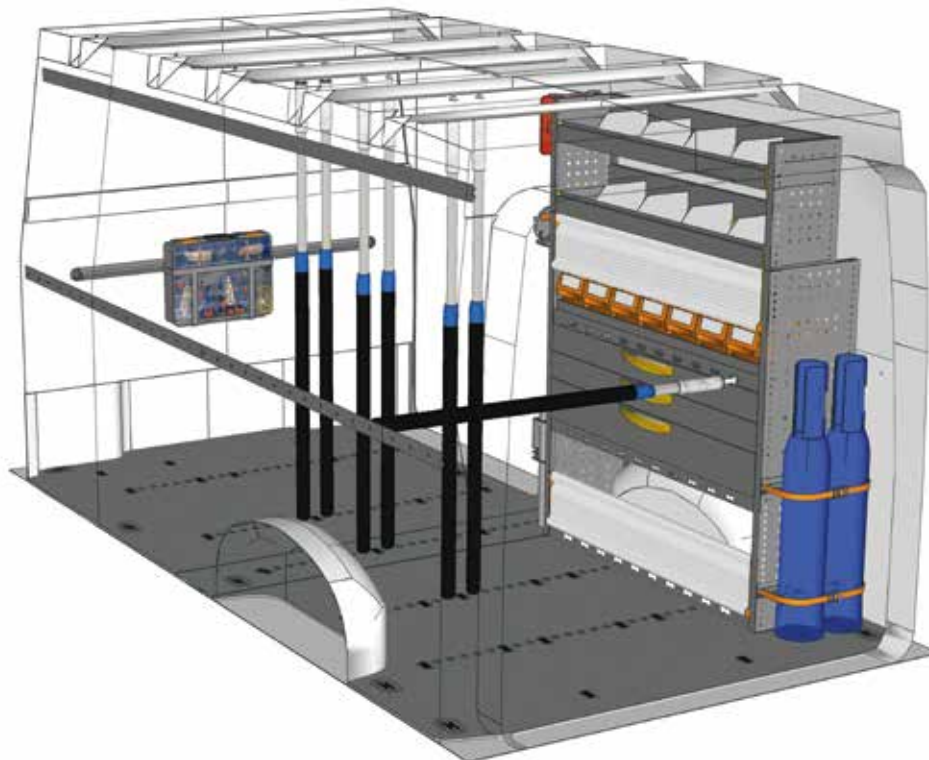

ESEMPIO - EXEMPLE

EXAMPLE CR L3H2 P2*



- | | |
|----------------|-------------|
| 1 x CR 1216 P2 | 1 x CPV080 |
| 1 x CR 30G1 A0 | 2 x V22136 |
| 1 x V22585 | 2 x V22124 |
| 7 x V22131 | 2 x V22148 |
| 5 x V18029 15 | 1 x YELLOW |
| 2 x V22106 | 4 x V225820 |
| 5 x V18025 15 | |
| 1 x BOX080 | |

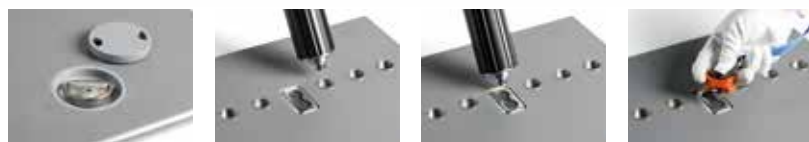

vedi pag. 10/11
voir page 10/11

* Kit fissaggio incluso - Jeu de fixation inclus

Non hai trovato il tuo allestimento?
Affidati ai nostri professionisti
Guarda il retro di questo catalogo e
contatta il punto Store Van più vicino
oppure visita il nostro sito.

**Vous n'avez pas trouvé votre
équipement ? Confiez-vous
à nos professionnels**
Voir au dos de ce catalogue
et contactez le point StoreVan
le plus proche ou visitez notre site web.



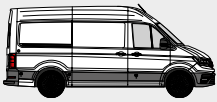

Standard, tetto alto - Standard, toit haut

MAN TGE

FURGONE LAMIERATO - FOURGON TÔLÉ

PROFESSIONAL

ESEMPI DI ALLESTIMENTO - EXEMPLES D'AMÉNAGEMENTS

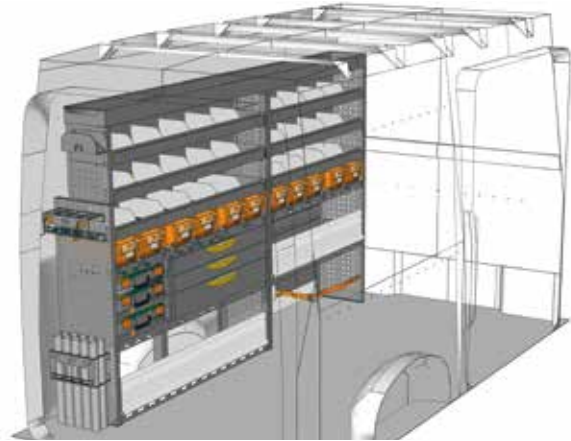

ESEMPIO - EXEMPLE

CR 2717 P1*

L=2540 P=365 H=1690 mm

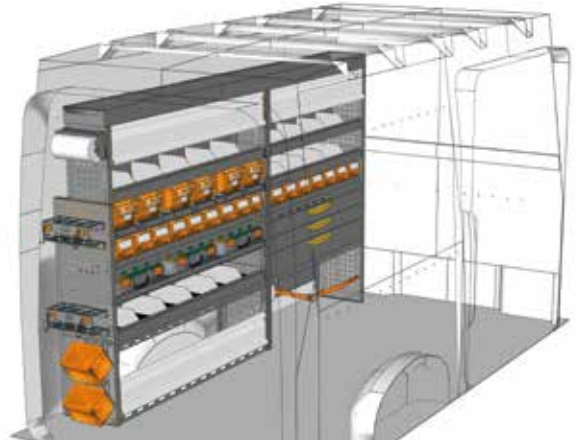
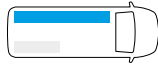

ESEMPIO - EXEMPLE

CR 2717 P2*

L=2540 P=365 H=1690 mm

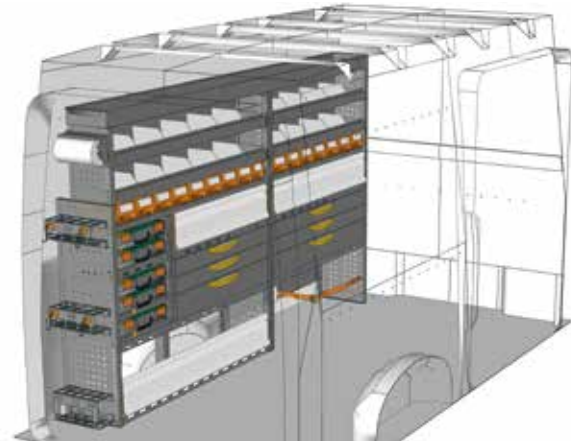
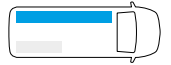

ESEMPIO - EXEMPLE

CR 2717 P3*

L=2540 P=365 H=1690 mm

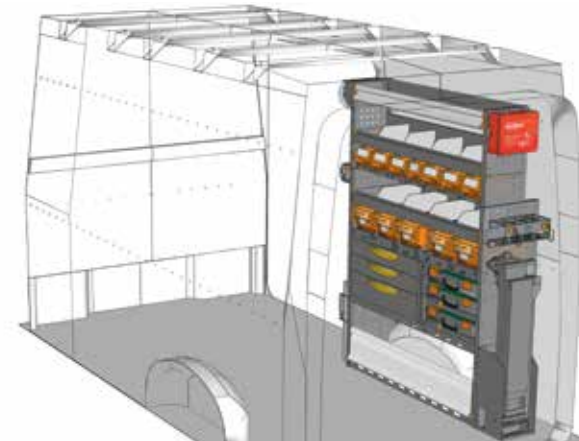
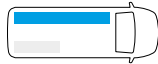

ESEMPIO - EXEMPLE

CR 1217 P1*

L=1225 P=365 H=1700 mm

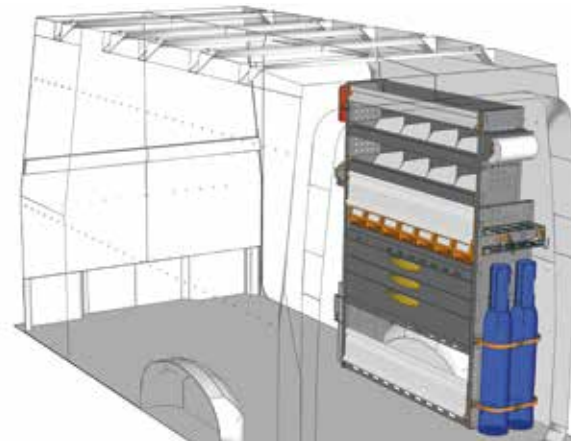
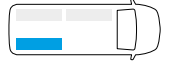

ESEMPIO - EXEMPLE

CR 1217 P2*

L=1225 P=365 H=1700 mm

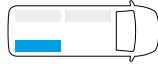

ESEMPIO - EXEMPLE

CR 1217 P3*

L=1225 P=365 H=1700 mm



* Kit fissaggio incluso - Jeu de fixation inclus

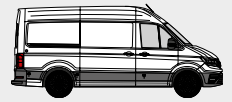

ESEMPI DI ALLESTIMENTO - EXEMPLES D'AMÉNAGEMENTS

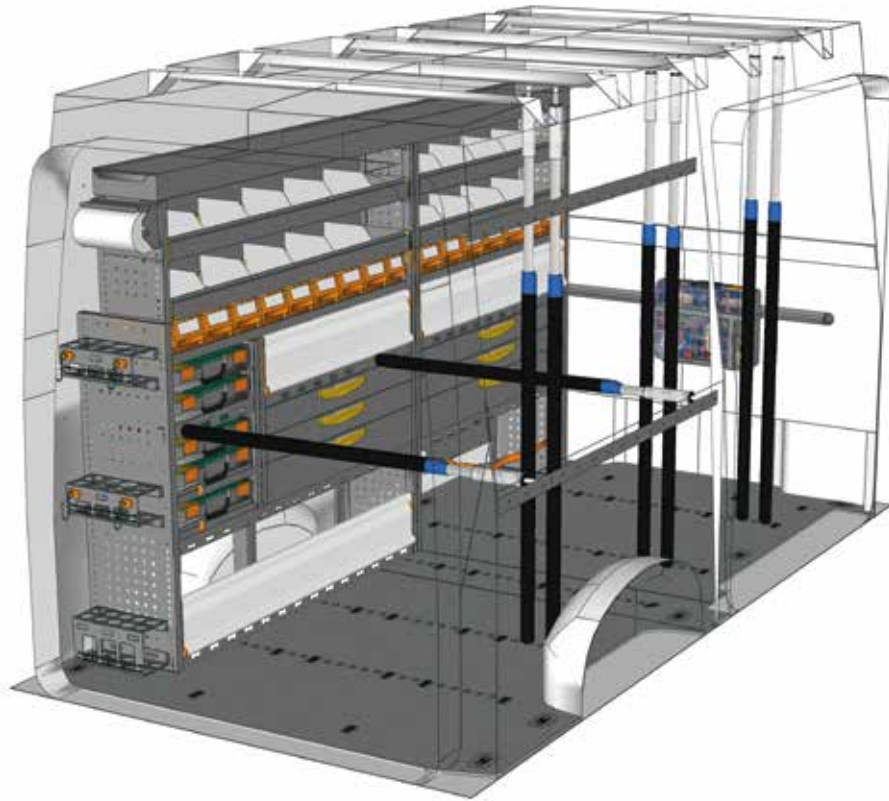

ESEMPIO - EXEMPLE

EXAMPLE CR L3H3 P1*



1 x CR 2717 P3	1 x BOX080
1 x CR 30G1 A0	1 x CPV080
1 x V22585	2 x V22136
2 x V22131	2 x V22124
6 x V22017	2 x V22148
3 x V18029 15	1 x YELLOW
2 x V22106	4 x V225820
5 x V18025 15	

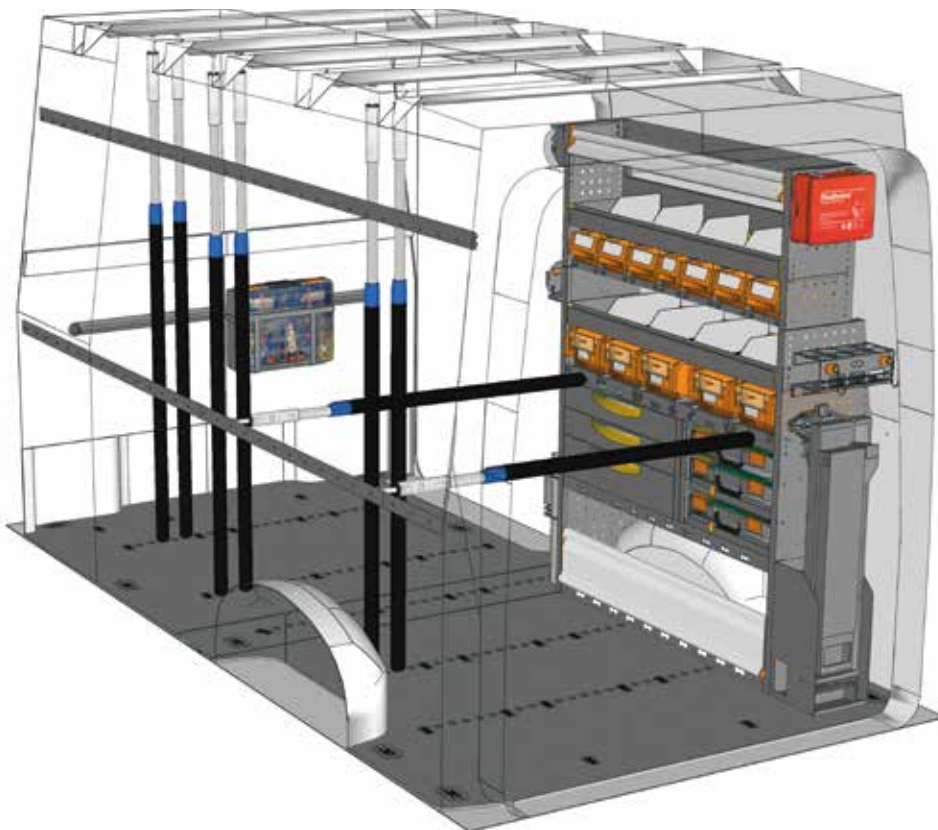

ESEMPIO - EXEMPLE

EXAMPLE CR L3H3 P2*



1 x CR 1217 P1	1 x BOX080
1 x CR 30G1 A0	1 x CPV080
1 x V22585	2 x V22136
2 x V22131	2 x V22124
6 x V22017	2 x V22148
5 x V18029 15	1 x YELLOW
2 x V22106	4 x V225820
5 x V18025 15	

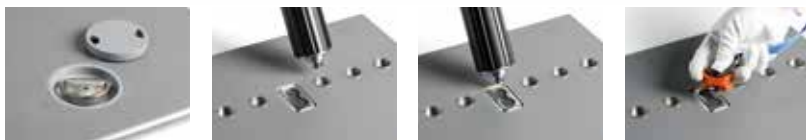

vedi pag. 10/11
voir page 10/11

* Kit fissaggio incluso - Jeu de fixation inclus

FURGONE LAMIERATO - FOURGON TÔLE
MAN TGE

PROFESSIONAL

**Non hai trovato il tuo allestimento?
Affidati ai nostri professionisti**

Guarda il retro di questo catalogo e
contatta il punto Store Van piu vicino
oppure visita il nostro sito.

**Vous n'avez pas trouvé votre
équipement ? Confiez-vous
à nos professionnels**

Voir au dos de ce catalogue
et contactez le point StoreVan
le plus proche ou visitez notre site web.



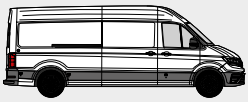

Lungo, tetto alto - Long, toit haut

MAN TGE
FURGONE LAMIERATO - FOURGON TÔLÉ
PROFESSIONAL

ESEMPI DI ALLESTIMENTO - EXEMPLES D'AMÉNAGEMENTS

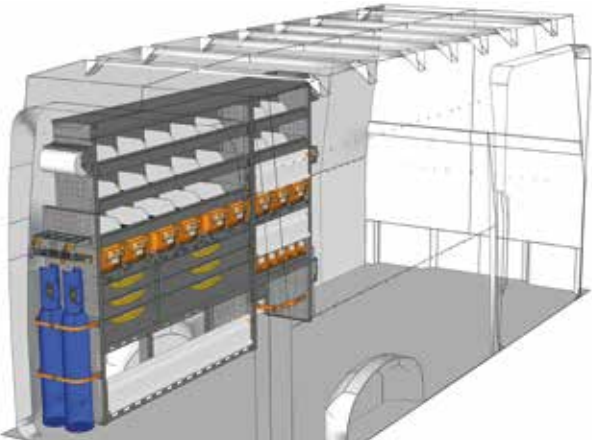

ESEMPIO - EXEMPLE

CR 2217 P1*

L=2241 P=365 H=1690 mm

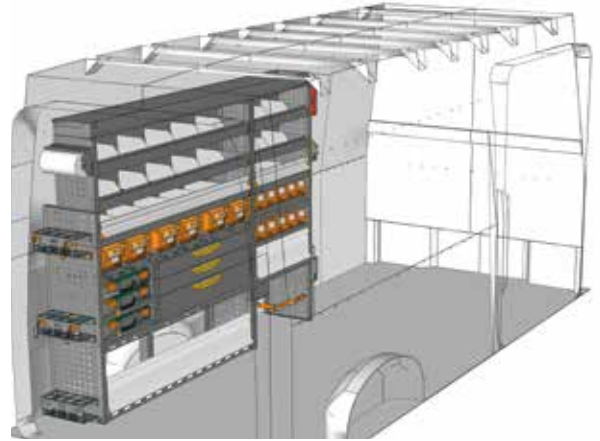
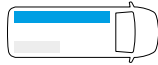

ESEMPIO - EXEMPLE

CR 2217 P2*

L=2241 P=365 H=1690 mm

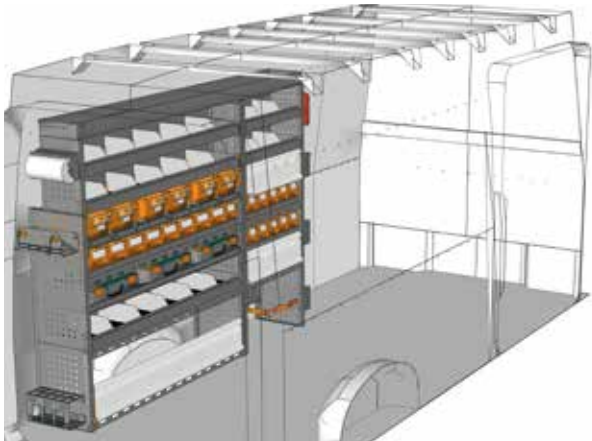

ESEMPIO - EXEMPLE

CR 2217 P3*

L=2241 P=365 H=1690 mm

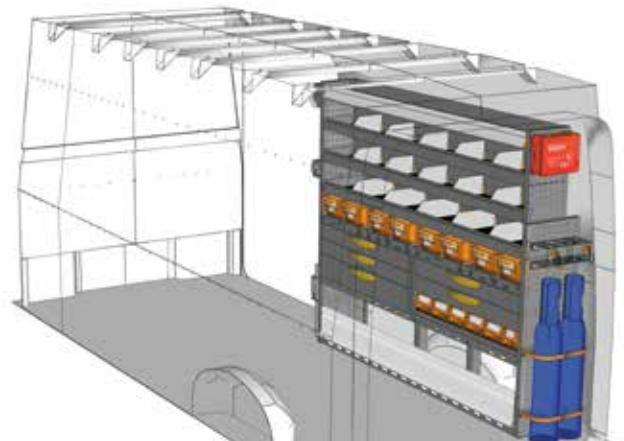
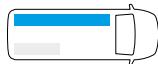

ESEMPIO - EXEMPLE

CR 2017 P1*

L=2032 P=365 H=1700 mm

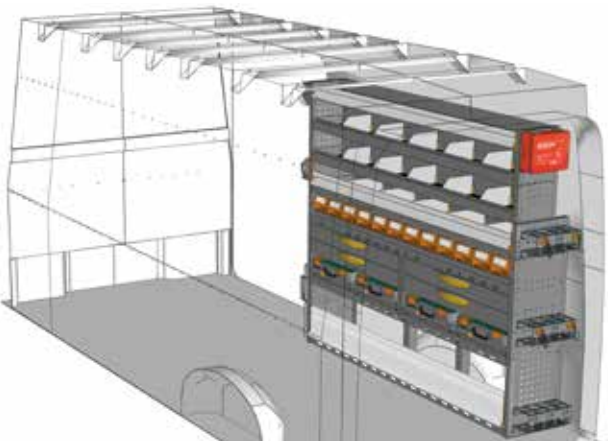

ESEMPIO - EXEMPLE

CR 2017 P2*

L=2032 P=365 H=1700 mm

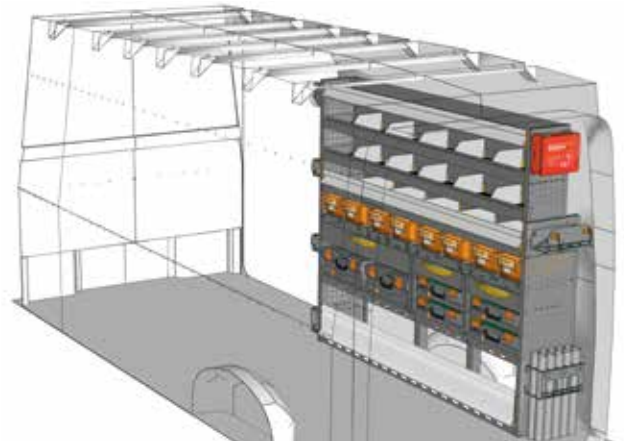
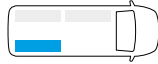

ESEMPIO - EXEMPLE

CR 2017 P3*

L=2032 P=365 H=1700 mm



* Kit fissaggio incluso - Jeu de fixation inclus

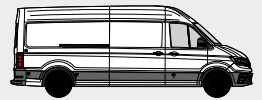

ESEMPI DI ALLESTIMENTO - EXEMPLES D'AMÉNAGEMENTS

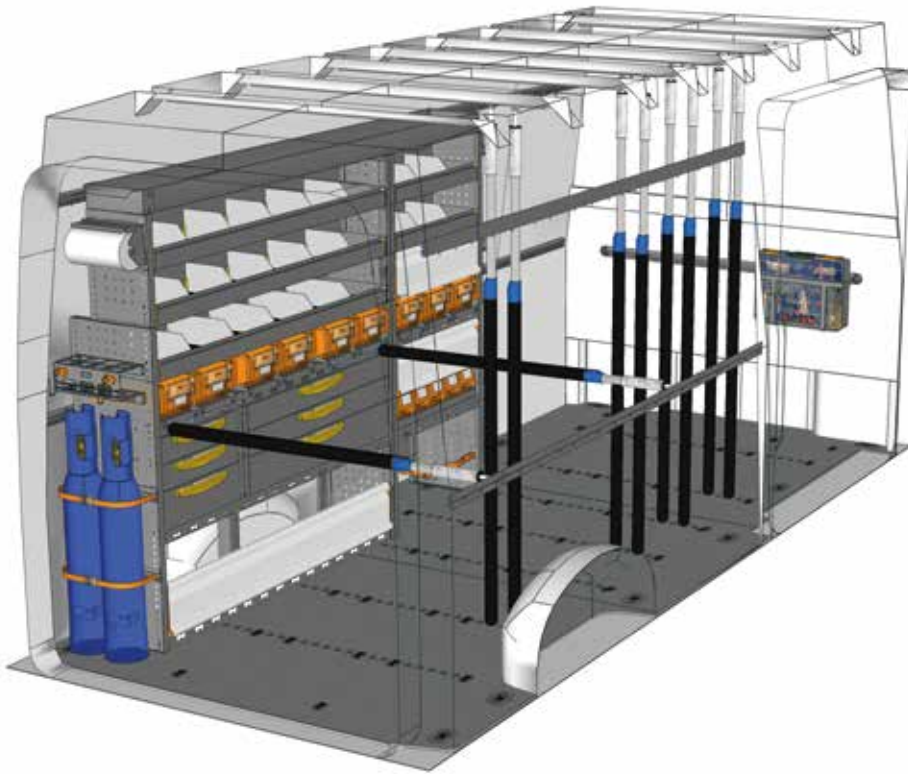

ESEMPIO - EXEMPLE

EXAMPLE CR L4H3 P1*



1 x CR 2217 P1	7 x V18025 15
1 x CR 40G1 A0	1 x B0X080
1 x V22585	1 x CPV080
2 x V22131	2 x V22136
8 x V22017	2 x V22124
3 x V18029 15	2 x V22148
2 x V18029 25	1 x YELLOW
2 x V22106	4 x V225820

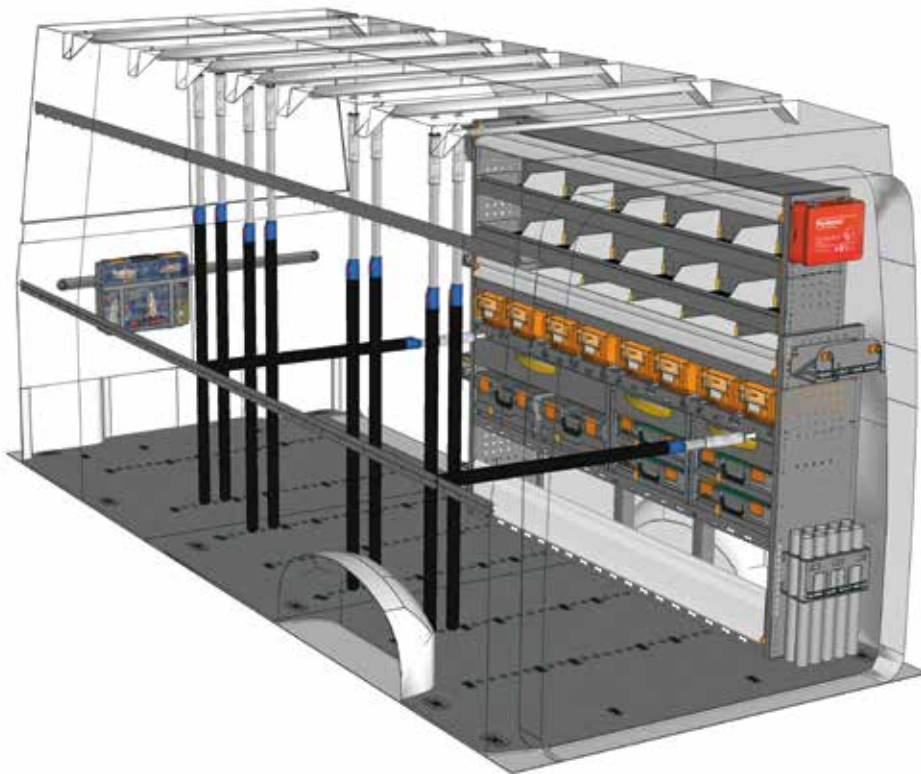

ESEMPIO - EXEMPLE

EXAMPLE CR L4H3 P2*



1 x CR 2017 P3	7 x V18025 15
1 x CR 40G1 A0	1 x B0X080
1 x V22585	1 x CPV080
2 x V22131	2 x V22136
8 x V22017	2 x V22124
3 x V18029 15	2 x V22148
2 x V18029 25	1 x YELLOW
2 x V22106	4 x V225820



vedi pag. 10/11
voir page 10/11

* Kit fissaggio incluso - Jeu de fixation inclus

**Non hai trovato il tuo allestimento?
Affidati ai nostri professionisti**

Guarda il retro di questo catalogo e
contatta il punto Store Van piu vicino
oppure visita il nostro sito.

**Vous n'avez pas trouvé votre
équipement ? Confiez-vous
à nos professionnels**

Voir au dos de ce catalogue
et contactez le point StoreVan
le plus proche ou visitez notre site web.





**La mobilità
oltre il veicolo**

**La mobilità
au-delà du
véhicule**

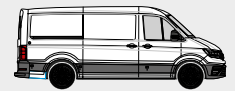

La soluzione MOBILE integra gli allestimenti per veicoli commerciali Store Van con le valigette portaminuterie serie STORE BOX 102 – 136 – 238 e il relativo carrello per facilitare l'utilizzatore dell'**officina mobile** nel trasporto della merce e dell'attrezzatura dal veicolo al luogo di lavoro.

I nuovi elementi di ancoraggio "Airline" aumentano la stabilità del modulo senza influenzarne il peso. Anche in questo caso vengono integrati nella scaffalatura degli elementi che permettono l'uso dei sistemi di trattenuta "Airline". Possono essere scelti sistemi di fissaggio del carico sia verticali che orizzontali grazie anche all'introduzione del pianale SAFETY FLOOR.

La solution MOBILE comprend les aménagements pour véhicules utilitaires Store Van avec les malles pour les petits composants série STORE BOX 102 – 136 – 238 et le chariot pour aider l'utilisateur de l'**atelier mobile** dans les opérations de transport de la marchandise et de l'outillage entre le véhicule et le lieu d'intervention.

Les nouveaux éléments d'arrimage « Airline » améliorent la stabilité du module sans augmenter son poids. Dans ce cas également, des éléments intégrés dans le rayonnage permettent l'utilisation des systèmes de maintien « Airline ». Il est également possible de choisir des systèmes de fixation du chargement aussi bien verticaux qu'horizontaux grâce à l'adoption du plancher SAFETY FLOOR.





Standard, tetto normale - Standard, toit standard

MAN TGE
FURGONE LAMIERATO - FOURGON TÔLÉ

MOBILE

ESEMPI DI ALLESTIMENTO - EXEMPLES D'AMÉNAGEMENTS

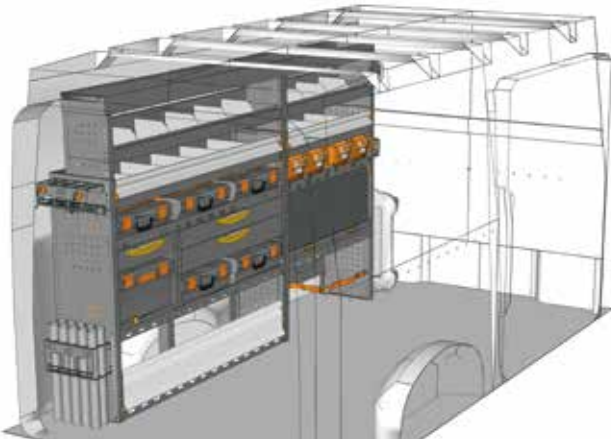

ESEMPIO - EXEMPLE

CR 2516 M1*

L=2540 P=365 H=1590 mm

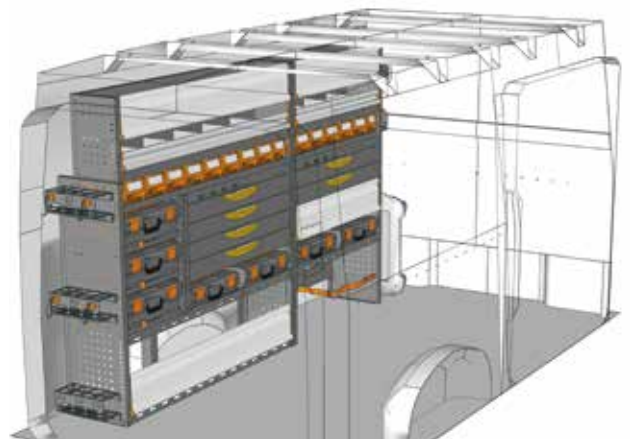

ESEMPIO - EXEMPLE

CR 2516 M2*

L=2540 P=365 H=1600 mm

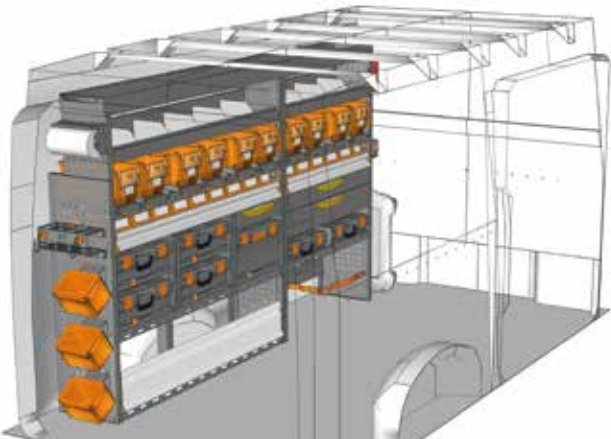
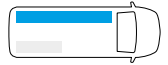

ESEMPIO - EXEMPLE

CR 2516 M3*

L=2540 P=365 H=1590 mm

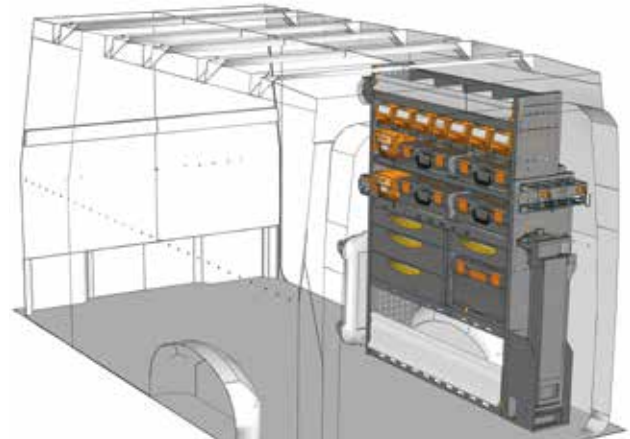

ESEMPIO - EXEMPLE

CR 1216 M1*

L=1225 P=365 H=1600 mm

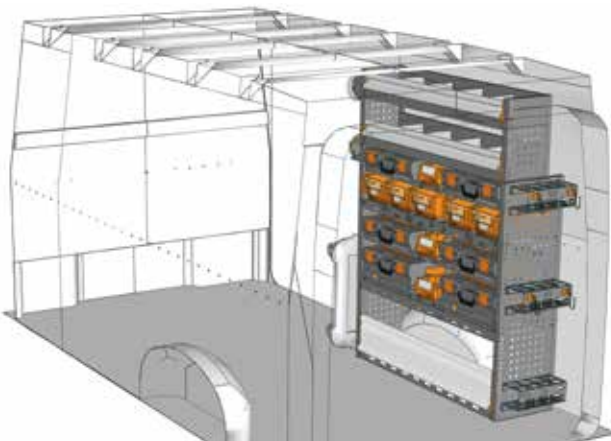
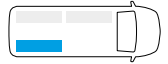

ESEMPIO - EXEMPLE

CR 1216 M2*

L=1225 P=365 H=1600 mm

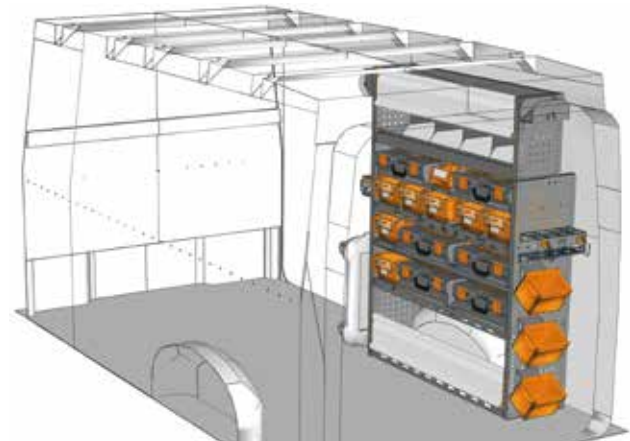
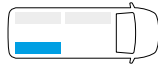

ESEMPIO - EXEMPLE

CR 1216 M3*

L=1225 P=365 H=1600 mm

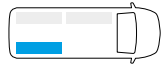

* Kit fissaggio incluso - Jeu de fixation inclus

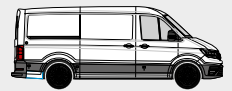

ESEMPI DI ALLESTIMENTO - EXEMPLES D'AMÉNAGEMENTS

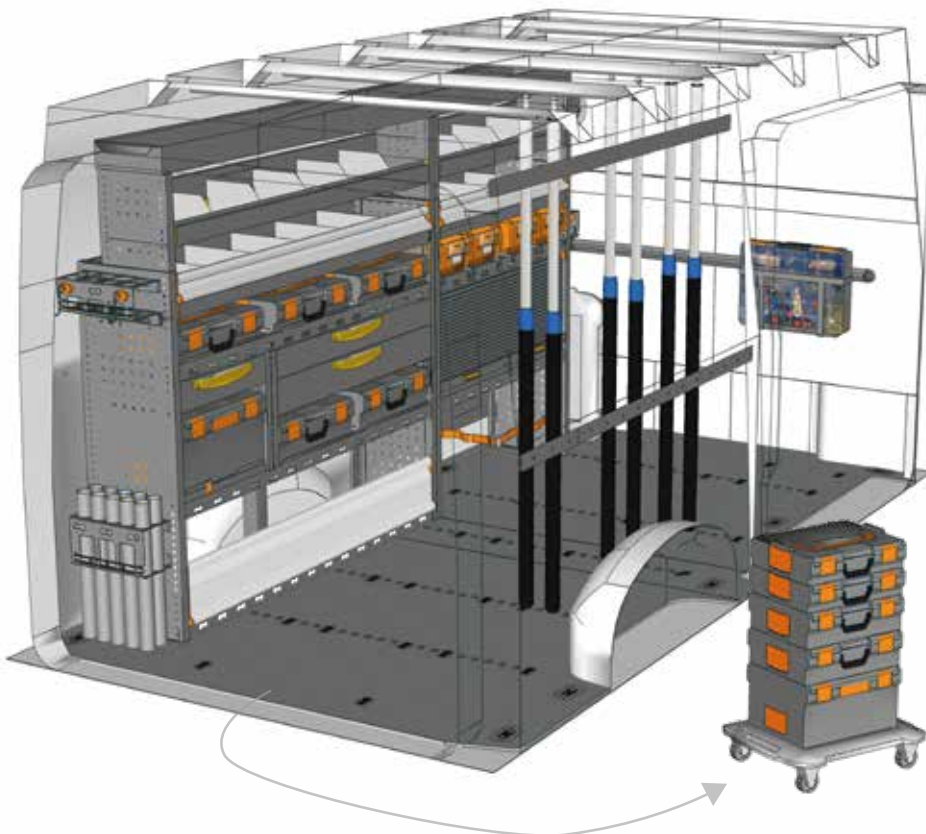

ESEMPIO - EXEMPLE

EXAMPLE CR L3H2 M1*



- | | |
|----------------|-------------|
| 1 x CR 2516 M1 | 1 x CPV080 |
| 1 x CR 30G1 A0 | 2 x V22136 |
| 1 x V22585 | 2 x V22124 |
| 6 x V22131 | 2 x V22148 |
| 3 x V18029 15 | 1 x YELLOW |
| 2 x V22106 | 4 x V225820 |
| 5 x V18025 15 | |
| 1 x BOX080 | |

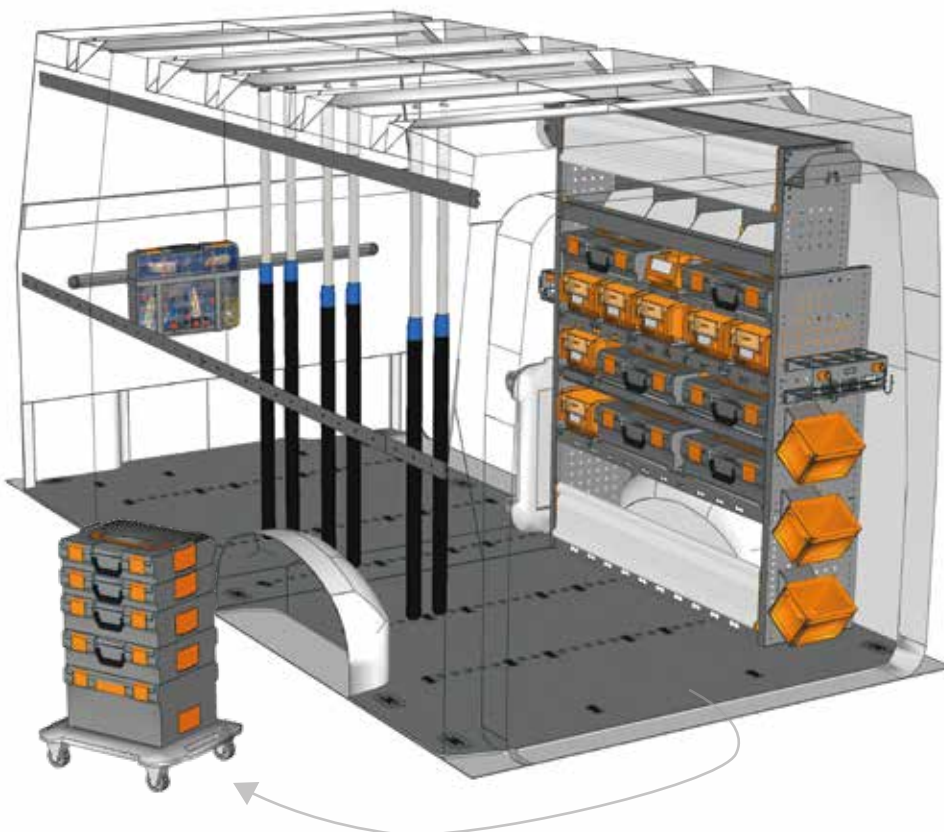

ESEMPIO - EXEMPLE

EXAMPLE CR L3H2 M2*



- | | |
|----------------|-------------|
| 1 x CR 1216 M3 | 1 x CPV080 |
| 1 x CR 30G1 A0 | 2 x V22136 |
| 1 x V22585 | 2 x V22124 |
| 6 x V22131 | 2 x V22148 |
| 5 x V18029 15 | 1 x YELLOW |
| 2 x V22106 | 4 x V225820 |
| 5 x V18025 15 | |
| 1 x BOX080 | |

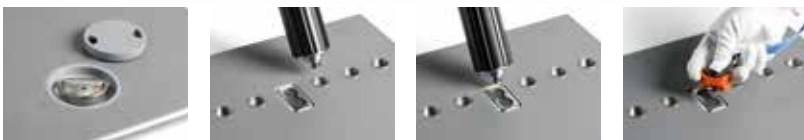

vedi pag. 10/11
voir page 10/11

* Kit fissaggio incluso - Jeu de fixation inclus

Non hai trovato il tuo allestimento?
Affidati ai nostri professionisti
Guarda il retro di questo catalogo e
contatta il punto Store Van più vicino
oppure visita il nostro sito.

**Vous n'avez pas trouvé votre
équipement ? Confiez-vous
à nos professionnels**
Voir au dos de ce catalogue
et contactez le point StoreVan
le plus proche ou visitez notre site web.



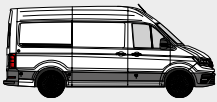

Standard, tetto alto - Standard, toit haut

MAN TGE
FURGONE LAMIERATO - FOURGON TÔLÉ

MOBILE

ESEMPIO DI ALLESTIMENTO - EXEMPLES D'AMÉNAGEMENTS

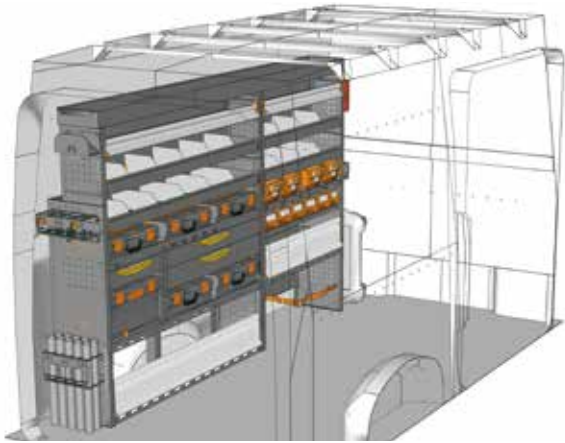

ESEMPIO - EXEMPLE

CR 2517 M1*

L=2540 P=365 H=1690 mm

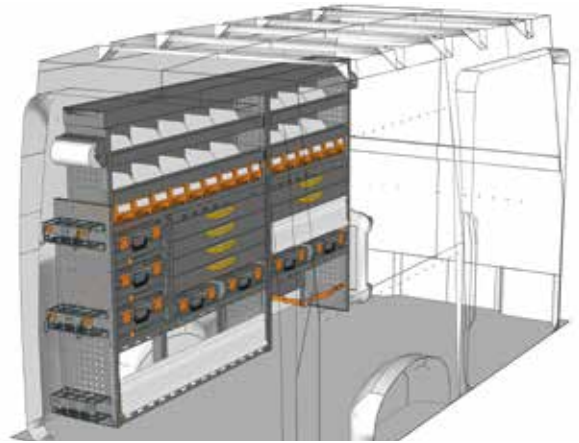

ESEMPIO - EXEMPLE

CR 2517 M2*

L=2540 P=365 H=1690 mm

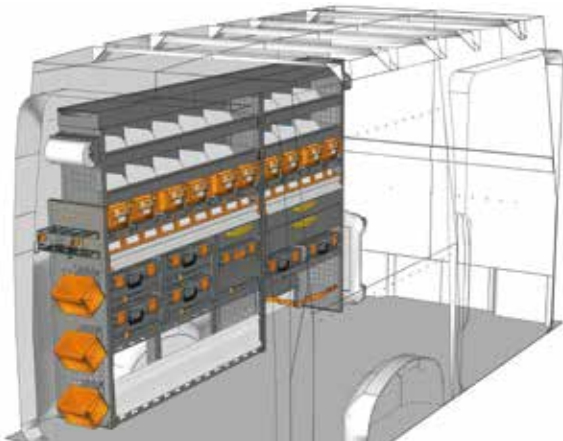

ESEMPIO - EXEMPLE

CR 2517 M3*

L=2540 P=365 H=1690 mm

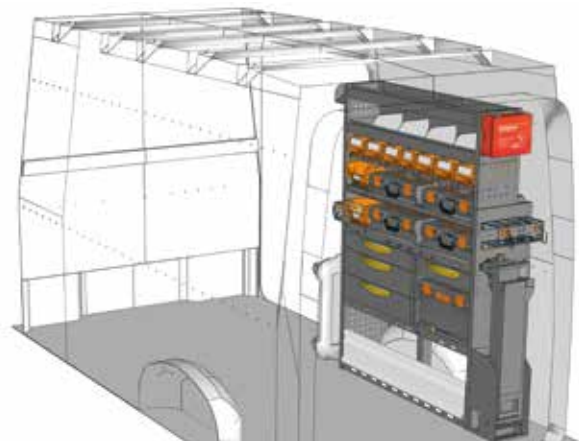
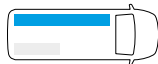

ESEMPIO - EXEMPLE

CR 1217 M1*

L=1225 P=365 H=1700 mm



ESEMPIO - EXEMPLE

CR 1217 M2*

L=1225 P=365 H=1700 mm

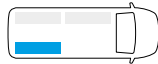

ESEMPIO - EXEMPLE

CR 1217 M3*

L=1225 P=365 H=1700 mm

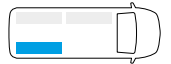

* Kit fissaggio incluso - Jeu de fixation inclus

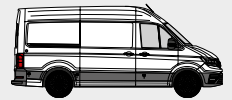

ESEMPI DI ALLESTIMENTO - EXEMPLES D'AMÉNAGEMENTS

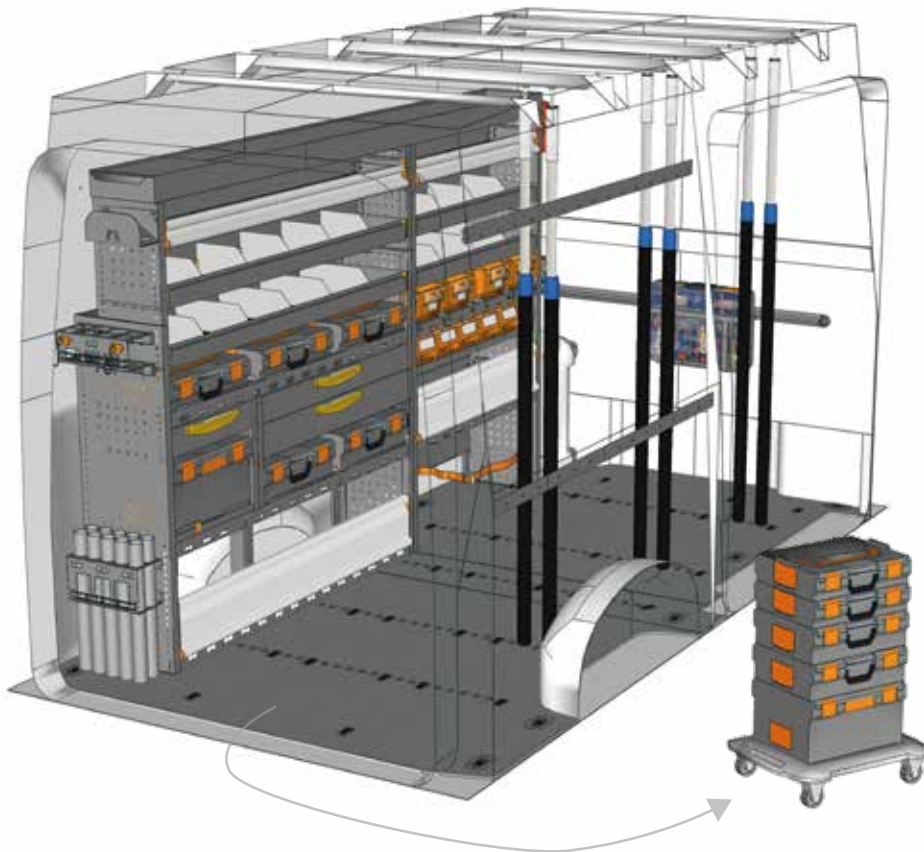

ESEMPIO - EXEMPLE

EXAMPLE CR L3H3 M1*



- | | |
|----------------|-------------|
| 1 x CR 2517 M1 | 1 x CPV080 |
| 1 x CR 30G1 A0 | 2 x V22136 |
| 1 x V22585 | 2 x V22124 |
| 6 x V22017 | 2 x V22148 |
| 3 x V18029 15 | 1 x YELLOW |
| 2 x V22106 | 4 x V225820 |
| 5 x V18025 15 | |
| 1 x BOX080 | |

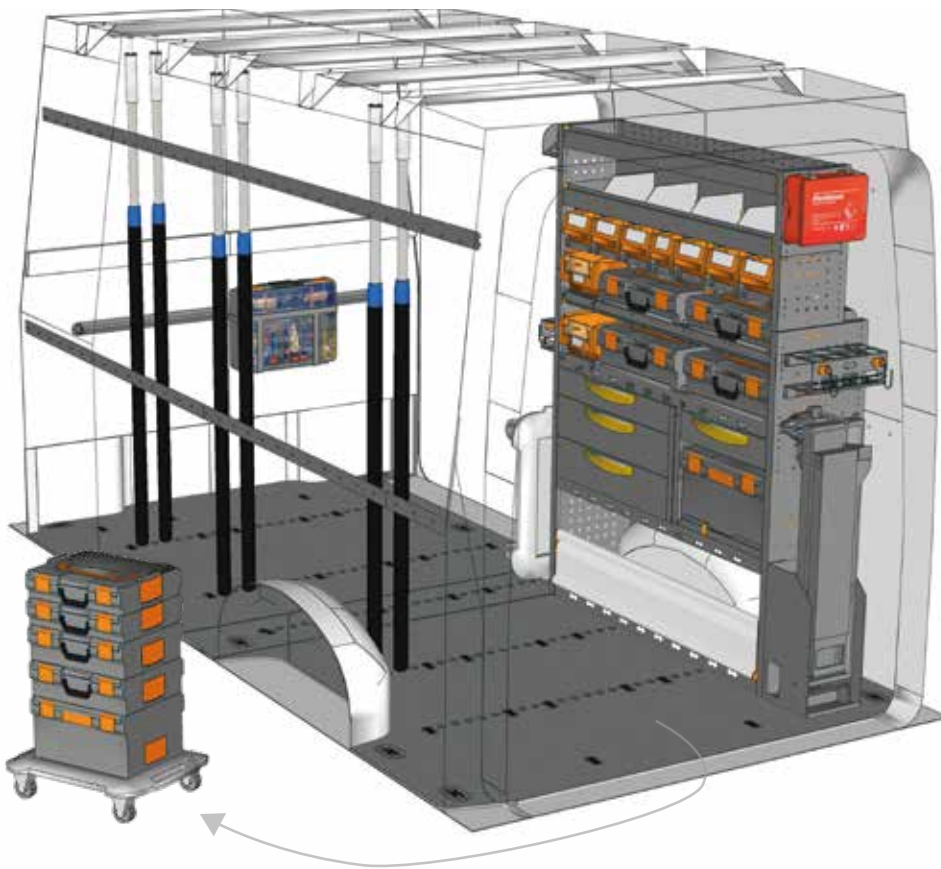

ESEMPIO - EXEMPLE

EXAMPLE CR L3H3 M2*



- | | |
|----------------|-------------|
| 1 x CR 1217 M1 | 1 x CPV080 |
| 1 x CR 30G1 A0 | 2 x V22136 |
| 1 x V22585 | 2 x V22124 |
| 6 x V22017 | 2 x V22148 |
| 5 x V18029 15 | 1 x YELLOW |
| 2 x V22106 | 4 x V225820 |
| 5 x V18025 15 | |
| 1 x BOX080 | |



vedi pag. 10/11
voir page 10/11

* Kit fissaggio incluso - Jeu de fixation inclus

Non hai trovato il tuo allestimento?

Affidati ai nostri professionisti

Guarda il retro di questo catalogo e
contatta il punto Store Van più vicino
oppure visita il nostro sito.

**Vous n'avez pas trouvé votre
équipement ? Confiez-vous
à nos professionnels**

Voir au dos de ce catalogue
et contactez le point StoreVan
le plus proche ou visitez notre site web.



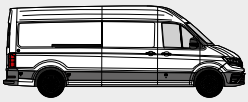

Lungo, tetto alto - Long, toit haut

MAN TGE
FURGONE LAMIERATO - FOURGON TÔLÉ

MOBILE

ESEMPI DI ALLESTIMENTO - EXEMPLES D'AMÉNAGEMENTS

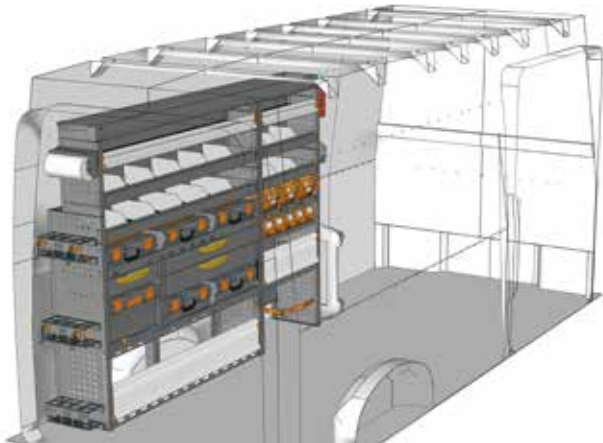

ESEMPIO - EXEMPLE

CR 2217 M1*

L=2241 P=365 H=1690 mm

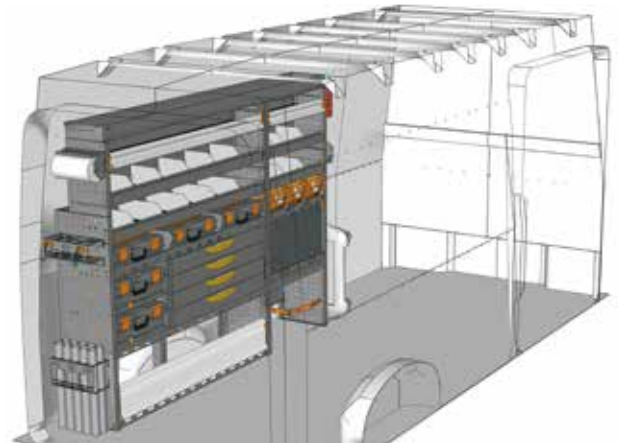

ESEMPIO - EXEMPLE

CR 2217 M2*

L=2241 P=365 H=1690 mm

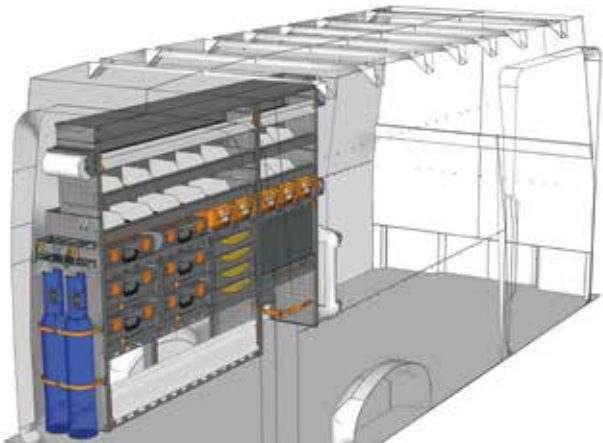
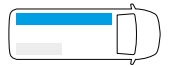

ESEMPIO - EXEMPLE

CR 2217 M3*

L=2241 P=365 H=1690 mm

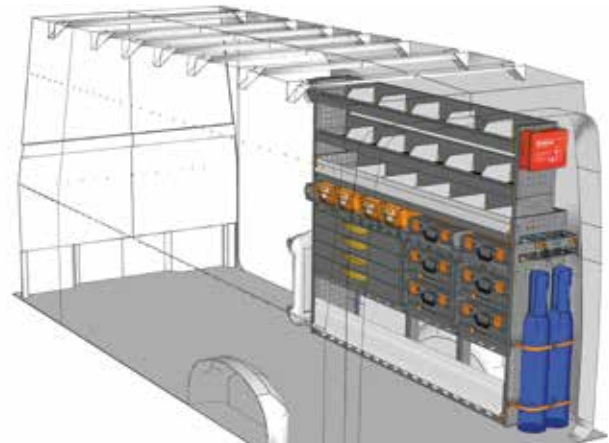

ESEMPIO - EXEMPLE

CR 2017 M1*

L=2032 P=365 H=1700 mm

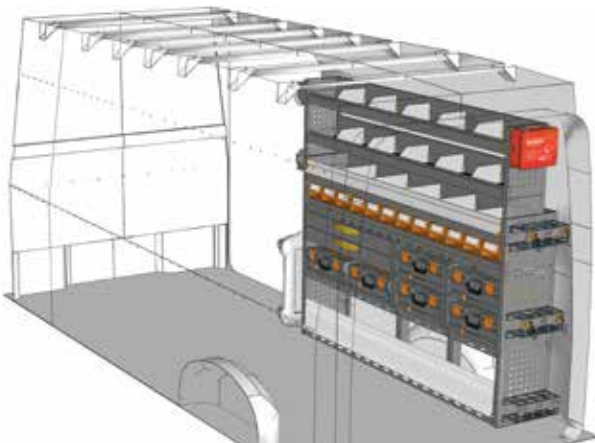
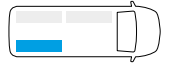

ESEMPIO - EXEMPLE

CR 2017 M2*

L=2032 P=365 H=1700 mm

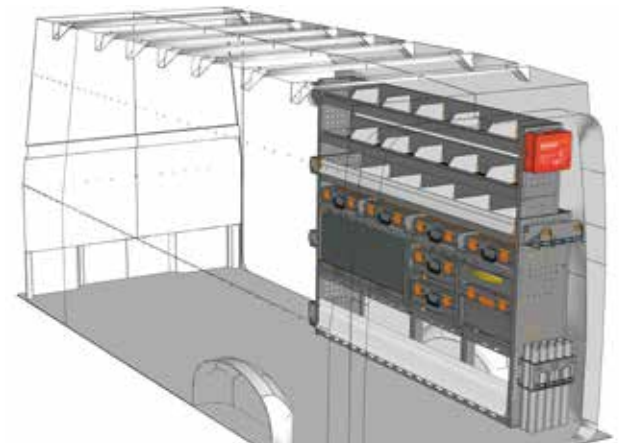
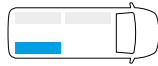

ESEMPIO - EXEMPLE

CR 2017 M3*

L=2032 P=365 H=1700 mm

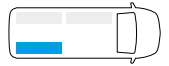

* Kit fissaggio incluso - Jeu de fixation inclus

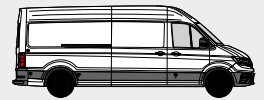

ESEMPI DI ALLESTIMENTO - EXEMPLES D'AMÉNAGEMENTS

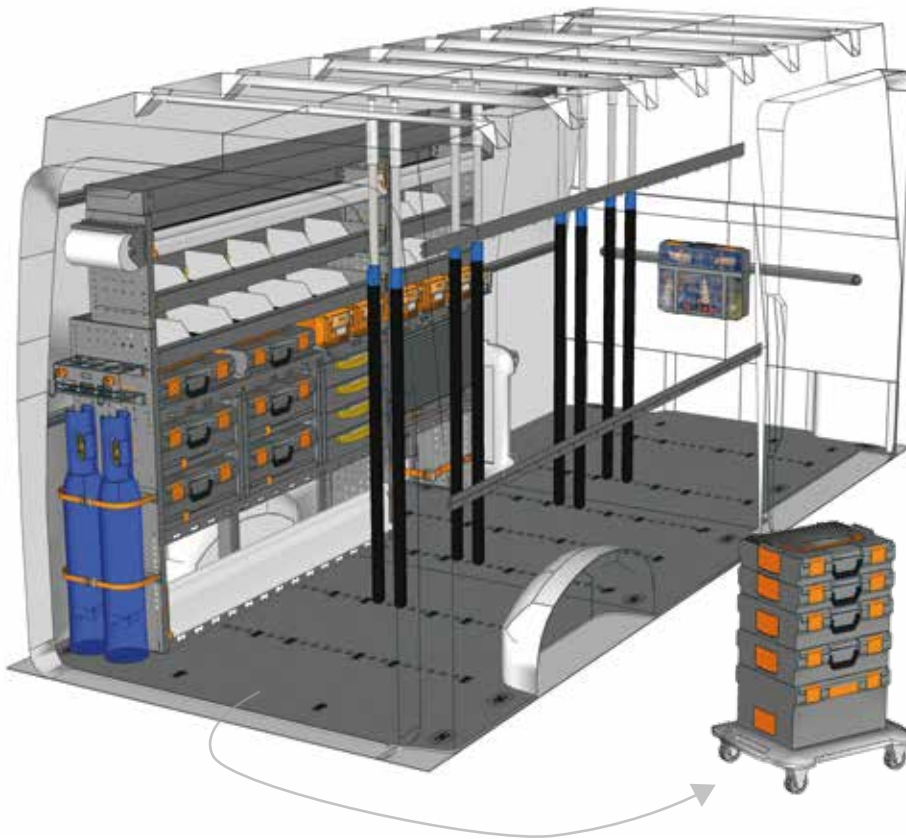

ESEMPIO - EXEMPLE

EXAMPLE CR L4H3 M1*



- | | |
|----------------|-------------|
| 1 x CR 2217 M3 | 1 x BOX080 |
| 1 x CR 40G1 A0 | 1 x CPV080 |
| 1 x V22585 | 2 x V22136 |
| 8 x V22017 | 2 x V22124 |
| 3 x V18029 15 | 2 x V22148 |
| 2 x V18029 25 | 1 x YELLOW |
| 2 x V22106 | 4 x V225820 |
| 7 x V18025 15 | |

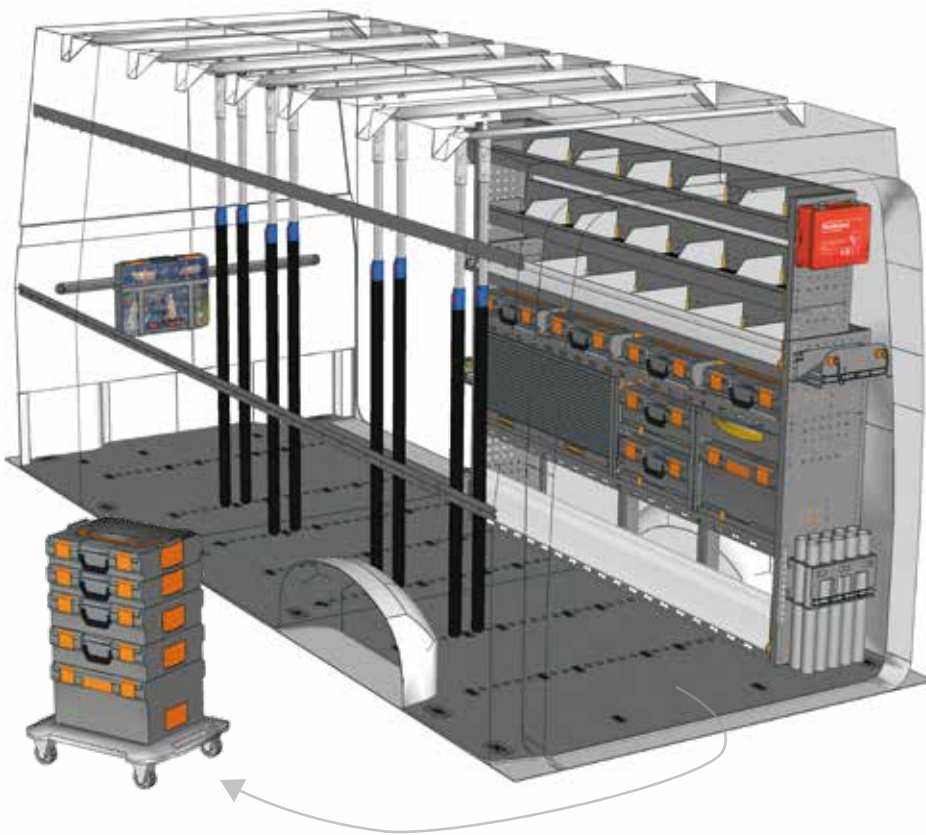

ESEMPIO - EXEMPLE

EXAMPLE CR L4H3 M2*



- | | |
|----------------|-------------|
| 1 x MA 1917 M3 | 1 x BOX080 |
| 1 x MA 30G1 A0 | 1 x CPV080 |
| 1 x V22585 | 2 x V22136 |
| 8 x V22017 | 2 x V22124 |
| 3 x V18029 15 | 2 x V22148 |
| 2 x V18029 20 | 1 x YELLOW |
| 10 x V22106 | 4 x V225820 |
| 4 x V18025 15 | |

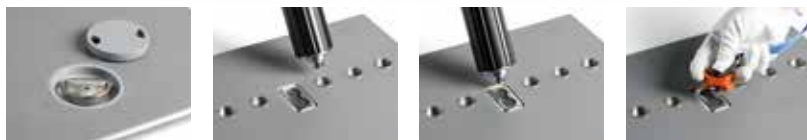

vedi pag. 10/11
voir page 10/11

* Kit fissaggio incluso - Jeu de fixation inclus

Non hai trovato il tuo allestimento?
Affidati ai nostri professionisti
Guarda il retro di questo catalogo e
contatta il punto Store Van piu vicino
oppure visita il nostro sito.

**Vous n'avez pas trouvé votre
équipement ? Confiez-vous
à nos professionnels**
Voir au dos de ce catalogue
et contactez le point StoreVan
le plus proche ou visitez notre site web.



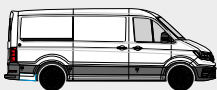

VEICOLO VÉHICULE	PORTATUTTO GALERIE DE TOIT	DIMENSIONI DIMENSIONS	PESO POIDS	PORTATA CHARGE
	ART.			
Modello - Modèle Standard, tetto normale Standard, toit standard	POT 116	3700x1600 mm	36,06 kg	263,00 kg
Modello - Modèle Standard, tetto alto Standard, toit haut	POT 116	3700x1600 mm	36,06 kg	263,00 kg

POT

- Portatutto completo di:
 - barre in alluminio complete di attacchi e profilo in gomma
 - sponde laterali in alluminio
 - rullo di caricamento in alluminio
 - viterie di fissaggio fornite in acciaio inox
- Galerie de toit complète de :
 - barres en aluminium avec fixations et profil en caoutchouc
 - rebords latéraux en aluminium
 - rouleau de chargement en aluminium
 - visserie de fixation fournie en acier inox



VEICOLO VÉHICULE	PORTASCALE PORTE-ÉCHELLES	DIMENSIONI DIMENSIONS	PESO POIDS	PORTATA CHARGE
	ART.			
Modello - Modèle Standard, tetto normale Standard, toit standard	POS 116	3700x1580 mm	62,63 kg	237,00 kg
Modello - Modèle Standard, tetto alto Standard, toit haut	POS 116	3700x1580 mm	62,63 kg	237,00 kg

POS

- Portascale completo di:
 - barre in alluminio complete di attacchi e profilo in gomma
 - sponda laterale in alluminio
 - rullo di caricamento in alluminio
 - slitta portascale in alluminio e acciaio inox
 - viterie di fissaggio fornite in acciaio inox
- Porte-échelles complet de :
 - barres en aluminium avec fixations et profil en caoutchouc
 - rebord latéral en aluminium
 - rouleau de chargement en aluminium
 - chariot porte-échelles en aluminium et acier inox
 - visserie de fixation fournie en acier inox



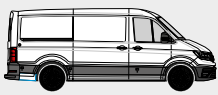

FURGONE LAMIERATO - FOURGON TÔLÉ
MAN TGE

ART. **PAP 265 00**

- Kit porta rotolo con carta Ø 130 mm
- Set support avec rouleau de papier Ø 130 mm

ART. **CAB 220 00**

- Sella reggicavi
- Support pour câbles

ART. **SPR 365 00**

- Porta bombolette P=365 mm
- Porte bombes aérosol P=365 mm

ART. **PAP 365 00**

- Kit porta rotolo con carta Ø 240 mm
- Set support avec rouleau de papier Ø 240 mm

ART. **CAB 296 00**

- Kit sella reggicavi
- Jeu support pour câbles

ART. **SIL 296 00**

- Kit porta silicone - bombolette
- Set porte silicon - bombes aérosols

ART. **LED 001 00**

- Lampada a led IP20 12V L=600mm
- Lampe à led IP20 12V L=600mm

ART. **WAS 365 00**

- Kit lavamani
- Set lavage des mains

ART. **AID 265 00**

- Kit pronto soccorso
- Trousse de premier secours

ART. **DOC 265 00**

- Tasca porta documenti DIN A4
- Pochette porte documents DIN A4

ART. **MAG 020**

- Kit 10 calamite Ø 20 mm
- Set de 10 aimants Ø 20mm

ART. **MAG 025**

- Kit 10 calamite Ø 25 mm
- Set de 10 aimants Ø 25mm



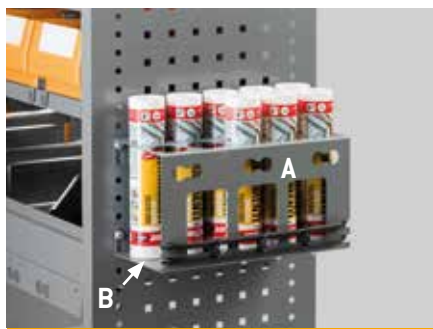
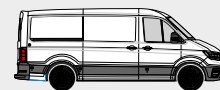

ART. **BAR 296 00** A

- Kit porta barre filettate
- Jeu porte-barres fileté

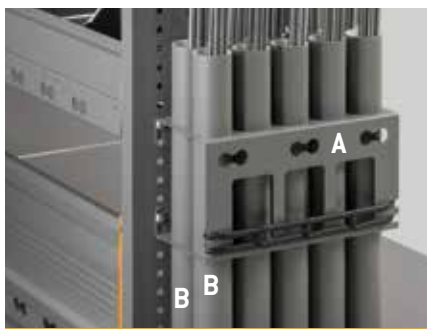

ART. **BAR 296 00** A

- Kit porta barre filettate
- Jeu porte-barres fileté

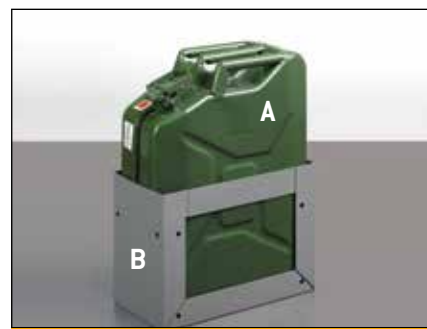

ART. **OIL 20L 00** A

- Tanica in ferro capacità 20 LT
- Bidon en fer 20 LT

ART. **BAR 296 02** B

- Adattatore per cartucce silicone
- Adaptateur pour cartouches silicone

ART. **BAR 296 01** B

- Kit 5 tubi per porta barre filettate
- Jeu de 5 tuyaux pour porte-barres fileté

ART. **OIL 365 00** B

- Porta tanica
- Porte - bidon

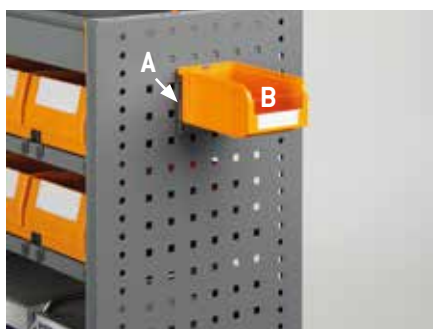

ART. **BL 7433 00** A

- Barra aggancio per 1 contenitore misura 1PL
- Barre porte bac pour 1 bac mesure 1PL

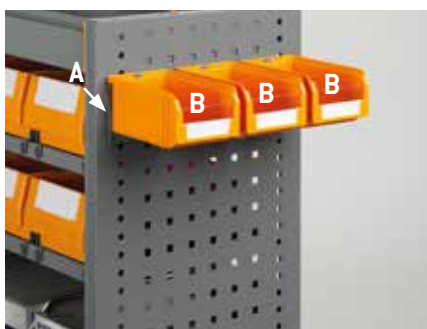

ART. **BL 7434 00** A

- Barra aggancio per 3 contenitori misura 1PL
- Barre porte bac pour 3 bacs mesure 1PL

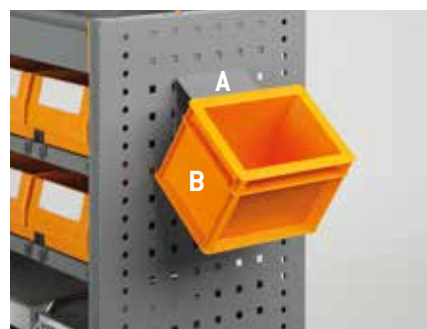

ART. **BL 7432 00** A

- Barra aggancio per 1 contenitore Athena
- Barre porte bac pour 1 bac Athena

ART. **PM 1751 00** B

- Contenitore in polipropilene misura 1PL
- Bac en polypropylène mesure 1PL

ART. **PM 1751 00** B

- Contenitore in polipropilene misura 1PL
- Bac en polypropylène mesure 1PL

ART. **PA 2251 A0** B

- Casseta in polipropilene serie Athena
- Caisse en polypropylène série Athena





ART. **FIR 000** A

- Kit porta bombole
- Set support pour bouteilles de gaz

ART. **FIR 4KG** B

- Estintore polvere 4 KG
- Extincteur (poudre) 4 KG



ART. **V18029 03** A

- Barra orizzontale fermacarico attacco foro medium L=365 mm
- Barre horizontale d'arrimage fixations trou medium L=365 mm

ART. **V18029 04** A

- Barra orizzontale fermacarico attacco foro medium L=445 mm
- Barre horizontale d'arrimage fixations trou medium L=445 mm

ART. **V22868** B

- Cinghia fermacarico con cricchetto attacco innesto medium
- Sangle d'arrimage à cliquet pour fixations medium



ART. **V18029 03** A

- Barra orizzontale fermacarico attacco foro medium L=365 mm
- Barre horizontale d'arrimage fixations trou medium L=365 mm

ART. **V18029 04** A

- Barra orizzontale fermacarico attacco foro medium L=445 mm
- Barre horizontale d'arrimage fixations trou medium L=445 mm

ART. **V22869** B

- Cinghia fermacarico con morsetto attacco innesto medium
- Sangle d'arrimage avec serrage pour fixations medium



Esempio con
2 ART. **FIR 000**
Exemple avec
2 ART. **FIR 000**



Esempio con
2 ART. **V18029 03**
2 ART. **V22868**
Exemple avec
2 ART. **V18029 03**
2 ART. **V22868**



Esempio con
2 ART. **V18029 03**
2 ART. **V22869**
Exemple avec
2 ART. **V18029 03**
2 ART. **V22869**

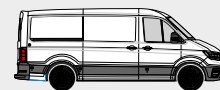

ART.

00 ROLL SU

A

- Kit supporti per STORE BOX ROLL
- Kit de supports pour STORE BOX ROLL

ART.

00 ROLL 00

B

- Carrello con ruote con freni per valigetta BOX 102-136-238-374
- Plateau roulant à frein pour mallette BOX 102-136-238-374



MAN TGE

CONDIZIONI DI FORNITURA

- Pianali e pannellature forniti in più pezzi.
- Portatutto e portascale vengono forniti **smontati**.
- I moduli vengono forniti **preassemblati** completi del materiale di ancoraggio al veicolo.
- Per l'installazione dei prodotti si consiglia di rivolgersi alla nostra rete di **installatori autorizzati**.
- I prodotti vengono forniti completi di **imballo**.
- **3 anni di garanzia** sui nostri prodotti.
- Le portate si riferiscono a **peso uniformemente distribuito**.

CONDITIONS DE FOURNITURE

- Planchers et habillages fournis en plusieurs éléments.
- Galeries de toit et porte-échelles sont fournis **démontés**.
- Les modules sont fournis **pré-montés**, avec le matériel de fixation au véhicule.
- Pour l'installation des produits, il est conseillé de s'adresser à notre réseau d'**installateurs agréés**.
- Les produits sont fournis **emballés**.
- **3 ans de garantie** sur nos produits.
- Les capacités de charge se réfèrent à **charge uniformément répartie**.



FAMI S.R.L.

VIA STAZIONE ROSSANO, 13 – 36027 ROSÀ (VI) ITALY
TEL +39 0424 585455 R.A. – FAX +39 0424 585482
INFO@FAMISPA.COM – WWW.FAMISPA.COM

INFO@STOREVAN.COM – WWW.STOREVAN.COM

