



**ALLESTIMENTI
VEICOLI COMMERCIALI**

**AMÉNAGEMENTS
DE VÉHICULES UTILITAIRES**



MERCEDES-BENZ SPRINTER



STORE VAN ORANGE PLANET - STOREVAN ORANGE PLANET

**STORE VAN ORANGE PLANET**

Sostenibilità ambientale e sviluppo eco-compatibile sono temi di rilevante attualità ed interesse, sorti dalla crescente consapevolezza che si debba prestare attenzione all'equilibrio ambientale.

STOREVAN ORANGE PLANET

La durabilité environnementale et le développement éco-compatibile sont des sujets importants d'actualité et d'intérêt, découlés d'une prise de conscience croissante qu'on doit prêter attention à l'équilibre environnemental.

CERTIFICAZIONI - CERTIFICATIONS

PRODUZIONE CERTIFICATA

- Certificati ISO 9001:2015.
- Superata brillantemente la prova di CRASH TEST eseguita secondo le ultime normative europee ECE-R17 con impatto a 50 Km/h.
- Certificazione GS per l'arredo interno e le rampe di carico.
- Certificazione GS per il portatutto-portascale.

PRODUCTION CERTIFIÉE

- Certifiés ISO 9001:2015.
- ESSAI DE CHOC réalisé selon les normes européennes ECE-R17 les plus récentes avec impact à 50 km/h, passé brillamment.
- Certification GS pour l'aménagement interne et les rampes de chargement.
- Certification GS pour les galeries de toit et porte-échelles.



CRASH TEST
ECE-R17



Store Van è l'unico produttore al mondo di allestimenti per veicoli commerciali ad utilizzare questa tecnologia.

StoreVan est le seul fabricant d'aménagements de véhicules utilitaires au monde à utiliser cette technologie.



ACCIAIO GALVANNEALED

La lamiera galvannealed è una variante della lamiera zincata a caldo. Il prodotto subisce un processo di zincatura a caldo e un successivo riscaldamento ad una temperatura di ca. 550°C attraverso il quale lo zinco si salda alla superficie della lamiera formando una lega con l'acciaio.

Il risultato che si ottiene è uno strato zincato uniforme e dalla struttura cristallina fine abbinati ad **una qualità della superficie e una resistenza alla corrosione nettamente superiori**. Questo processo è ideale per le applicazioni automotive. Store Van ha introdotto e implementato tale tecnologia anche nel settore dell'allestimento veicoli industriali.

VERNICIATURA PER IMMERSIONE - CATODICA - CON RESINA ACRILICA

La verniciatura per cataforesi è un trattamento superficiale di verniciatura in grado di conferire agli elementi dell'allestimento una **notevole resistenza alla corrosione**; è caratterizzata dal **deposito uniforme** di una resina acrilica sulla superficie dell'elemento, assicurando per lungo tempo un'elevata protezione nei confronti degli agenti chimici e di altri tipi di attacchi. La resina acrilica consente una diretta esposizione agli agenti atmosferici mantenendo inalterate le caratteristiche tecniche. Con questo processo si assicura una maggiore protezione dalla ruggine.

- Resistenza alla corrosione superiore a 500 ore (umidità ASTM D1735)
- Eccellente durezza con valutazione minima 2H



ACIER GALVANNEALED

La tôle galvannealed est une variante de la tôle galvanisée à chaud. Le produit est soumis à un procédé de galvanisation à chaud, puis de chauffage à une température d'env. 550 °C par lequel le zinc se soude à la surface de la tôle en formant un alliage avec l'acier.

Le résultat obtenu est une couche de zinc uniforme et une structure cristalline fine combinées à **une qualité de la surface et une résistance à la corrosion nettement plus élevées**. Ce procédé est idéal pour les applications au sein du secteur automobile. StoreVan a introduit et optimisé cette technologie également dans le domaine des aménagements de véhicules utilitaires.

PEINTURE PAR IMMERSION - CATHODIQUE - AVEC RESINE ACRYLIQUE

La peinture cathodique est un traitement de surface qui permet de conférer aux éléments de l'aménagement **une résistance remarquable à la corrosion** ; elle est caractérisée par le **dépôt uniforme** d'une résine acrylique sur la surface de l'élément, en garantissant une haute et durable protection contre les agents chimiques et d'autres types d'agressions. La résine acrylique permet une exposition directe aux agents atmosphériques, tout en conservant inchangées les caractéristiques techniques. Ce procédé garantit aussi une meilleure protection contre la rouille.

- Résistance à la corrosion supérieure à 500 heures (humidité ASTM D1735)
- Excellente dureté avec une évaluation minimale 2H







MERCEDES-BENZ SPRINTER

FURGONE LAMIERATO - FOURGON TÔLÉ

PIANALE E PANNELLATURE - PLANCHER ET HABILLAGES

- Pianale e pannellature per veicolo con porta laterale destra e pareti lamierate.
- Plancher et habillages pour véhicule avec porte latérale droite et parois en tôle.

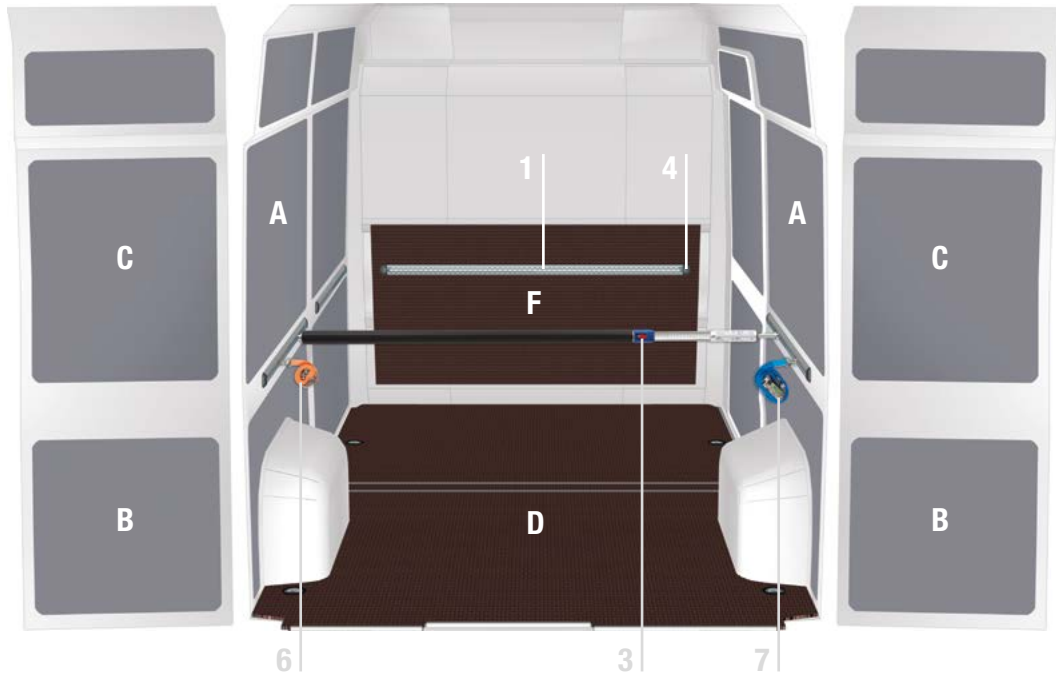

| VEICOLO VÉHICULE | PIANALE 12 mm PLANCHER 12 mm | PANNELLATURA HABILLAGE | PANNELLATURA HABILLAGE | RETROCABINA ARRIÈRE CABINE |
|--|---------------------------------|----------------------------|---------------------------|-------------------------------|
| | D | A+B | C | F |
| | ART. | ART. | ART. | ART. |
| Modello - Modèle L1 H1 ^A Compact, Tetto Normale Court, Toit Normal | PIL 107 33,26 kg | PAN 113 13,61 kg | PAR 107 1,63 kg | PIR 103 8,95 kg |
| Modello - Modèle L1 H2 ^A Compact, Tetto Alto Court, Toit Surélevé | PIL 107 33,26 kg | PAN 119 16,11 kg | PAR 108 2,81 kg | PIR 103 8,95 kg |
| Modello - Modèle L2 H1 ^A Standard, Tetto Normale Moyen, Toit Normal | PIL 108 41,92 kg | PAN 114 16,71 kg | PAR 107 1,63 kg | PIR 103 8,95 kg |
| Modello - Modèle L2 H1 ^B Standard, Tetto Normale Moyen, Toit Normal | PIL 109 38,98 kg | PAN 114 16,71 kg | PAR 107 1,63 kg | PIR 103 8,95 kg |
| Modello - Modèle L2 H2 / H3 ^A Standard, Tetto Alto / Super-alto Moyen, Toit Surélevé / Super Surélevé | PIL 108 41,92 kg | PAN 115 22,44 kg | PAR 108 2,81 kg | PIR 103 8,95 kg |
| Modello - Modèle L2 H2 / H3 ^B Standard, Tetto Alto / Super-alto Moyen, Toit Surélevé / Super Surélevé | PIL 109 38,98 kg | PAN 115 22,44 kg | PAR 108 2,81 kg | PIR 103 8,95 kg |
| Modello - Modèle L3 H2 / H3 ^A Long, Tetto Alto / Super-alto Long, Toit Surélevé / Super Surélevé | PIL 110 57,12 kg | PAN 116 29,98 kg | PAR 108 2,81 kg | PIR 103 8,95 kg |
| Modello - Modèle L3 H2 / H3 ^B Long, Tetto Alto / Super-alto Long, Toit Surélevé / Super Surélevé | PIL 111 54,26 kg | PAN 116 29,98 kg | PAR 108 2,81 kg | PIR 103 8,95 kg |
| Modello - Modèle L3L H2 / H3 ^A Extralong, Tetto Alto / Super-alto Extra Long, Toit Surélevé / Super Surélevé | PIL 112 62,92 kg | PAN 117 30,89 kg | PAR 108 2,81 kg | PIR 103 8,95 kg |
| Modello - Modèle L3L H2 / H3 ^B Extralong, Tetto Alto / Super-alto Extra Long, Toit Surélevé / Super Surélevé | PIL 113 60,14 kg | PAN 117 30,89 kg | PAR 108 2,81 kg | PIR 103 8,95 kg |

^A Ruote singole - Roues individuelles

^B Ruote gemellate - Roues jumelées

PIANALE E PANNELLATURE - PLANCHER ET HABILLAGES



PAN

- Pannellatura in polipropilene per:
 - parete laterale sinistra
 - parete laterale destra e porta scorrevole
 - parte inferiore delle porte posteriori a battente
- Habillage en polypropylène pour :
 - paroi latérale gauche
 - paroi latérale droite et porte coulissante
 - partie inférieure des portes arrière battantes

PAR

- Pannellatura in polipropilene per:
 - parte superiore delle porte posteriori a battente
- Habillage en polypropylène pour :
 - partie supérieure des portes arrière battantes



PIL

- Pianale in legno spessore 12 mm con rivestimento fenolico e predisposizione per gli ancoraggi originali del veicolo
- Plancher en bois de 12 mm avec revêtement phénolique et équipé pour les ancrages originaux du véhicule

PIR

- Pannello retrocabina in legno spessore 12 mm con rivestimento fenolico
- Panneau arrière cabine en bois de 12 mm d'épaisseur avec revêtement phénolique

SICUREZZA DEL CARICO - SÉCURISATION DU CHARGEMENT



DESCRIZIONE - DESCRIPTION

- Barra orizzontale in alluminio.
- Barre horizontale en aluminium.

BARRA - BARRE

1

LUNGHEZZA - LONGUEUR

ART. F 22 FC V18029 05 00
 ART. F 22 FC V18029 10 00
 ART. F 22 FC V18029 15 00
 ART. F 22 FC V18029 20 00
 ART. F 22 FC V18029 25 00

500 mm
 1000 mm
 1500 mm
 2000 mm
 2500 mm



DESCRIZIONE - DESCRIPTION

- Barra orizzontale in alluminio per fiancate.
- Barre horizontale en aluminium pour cotés.

BARRA - BARRE

2

LUNGHEZZA - LONGUEUR

ART. F 22 FC V18025 05 00
 ART. F 22 FC V18025 10 00
 ART. F 22 FC V18025 15 00

500 mm
 1000 mm
 1500 mm



DESCRIZIONE - DESCRIPTION

- Barra telescopica fermacarico.
- Barre télescopique d'arrimage.

BARRA - BARRE

3

ALTEZZA - HAUTEUR

ART. F 22 FC V22149 00 00
 ART. F 22 FC V22131 00 00
 ART. F 22 FC V22017 00 00

650-900 mm
 1250-1750 mm
 1550-2050 mm



DESCRIZIONE - DESCRIPTION

- Finale in plastica per barra serie V18029.
- Bouchon en plastique pour barre série V18029.

FINALE PER BARRA - BOUCHON POUR BARRE

4

ART. F 22 FC V22106 00 00



DESCRIZIONE - DESCRIPTION

- Anello fermacarico.
- Anneau d'arrimage.

ANELLO FERMACARICO - ANNEAU D'ARRIMAGE

5

ART. F 22 FC V22090 00 00



DESCRIZIONE - DESCRIPTION

- Cinghia fermacarico con morsetto 2500+500.
- Sangle d'arrimage avec crochet 2500+500.

CINGHIA - SANGLE

6

ART. F 22 FC V22136 00 00



DESCRIZIONE - DESCRIPTION

- Cinghia fermacarico con cricchetto 2500+500.
- Sangle d'arrimage à cliquet 2500+500.

CINGHIA - SANGLE

7

ART. F 22 FC V22124 00 00

Per maggiori informazioni richiedi il catalogo
 "Sicurezza del carico"

Pour plus d'informations, demandez le catalogue
 "Sécurisation du chargement"





ESEMPI DI ALLESTIMENTO - EXEMPLES D'AMÉNAGEMENTS



ESEMPIO - EXEMPLE

SP 2215 01*

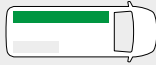

L=2241 P=365 H=1540 mm



ESEMPIO - EXEMPLE

SP 2215 02*

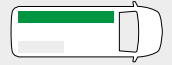

L=2241 P=365 H=1540 mm

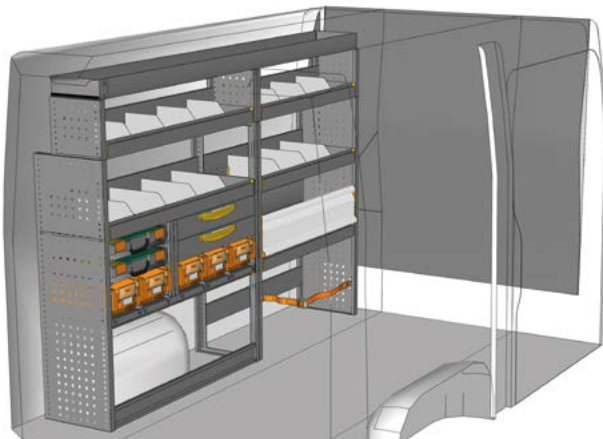

ESEMPIO - EXEMPLE

SP 2215 03*

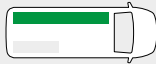

L=2241 P=365 H=1540 mm



ESEMPIO - EXEMPLE

SP 2215 04*

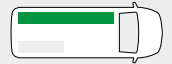

L=2241 P=365 H=1540 mm

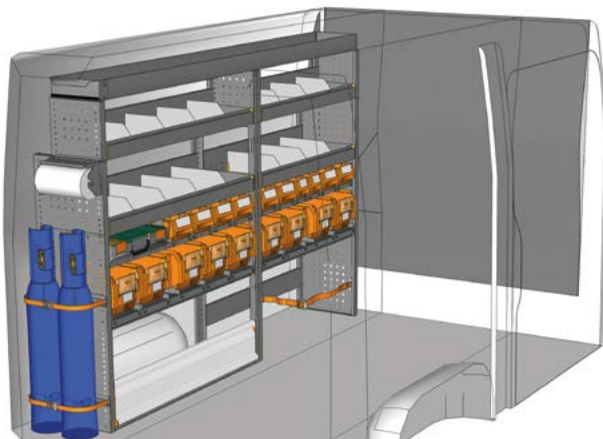

ESEMPIO - EXEMPLE

SP 2215 05*

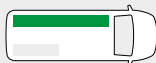

L=2241 P=365 H=1540 mm



ESEMPIO - EXEMPLE

SP 2215 06*

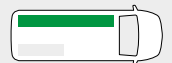

L=2241 P=365 H=1540 mm



ESEMPI DI ALLESTIMENTO - EXEMPLES D'AMÉNAGEMENTS

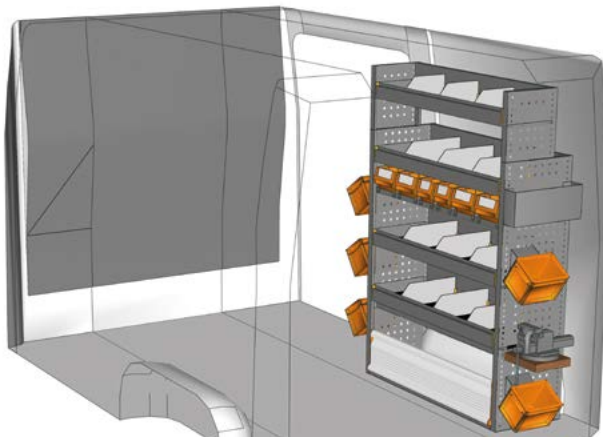

ESEMPIO - EXEMPLE

SP 1015 01*

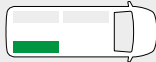

L=1016 P=365 H=1500 mm

**Non hai trovato il tuo allestimento?
Affidati ai nostri professionisti**

Guarda il retro di questo catalogo e
contatta il punto Store Van piu vicino
oppure visita il nostro sito.



**Vous n'avez pas trouvé votre
équipement ? Confiez-vous
à nos professionnels**

Voir au dos de ce catalogue
et contactez le point StoreVan
le plus proche ou visitez notre site web.

*** Kit fissaggio incluso - Jeu de fixation inclus**

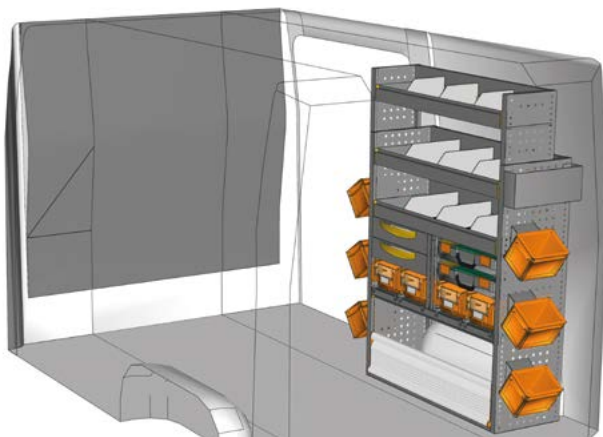

ESEMPIO - EXEMPLE

SP 1015 02*



L=1016 P=365 H=1500 mm

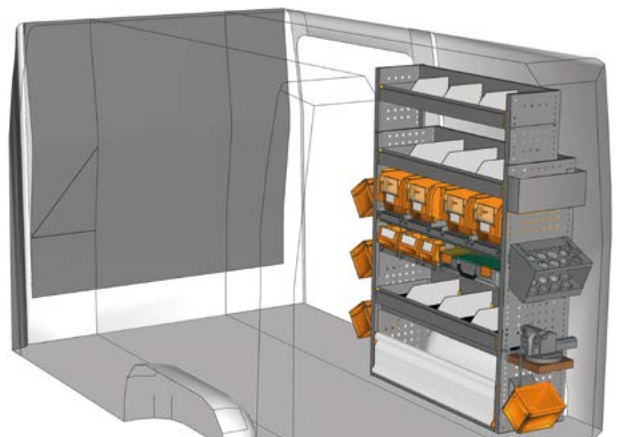

ESEMPIO - EXEMPLE

SP 1015 03*



L=1016 P=365 H=1500 mm

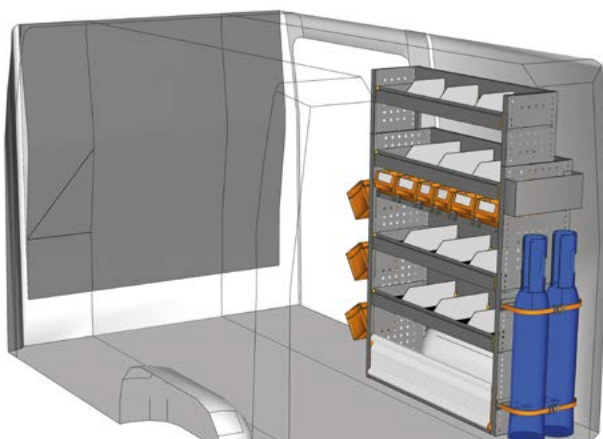

ESEMPIO - EXEMPLE

SP 1015 04*



L=1016 P=365 H=1500 mm

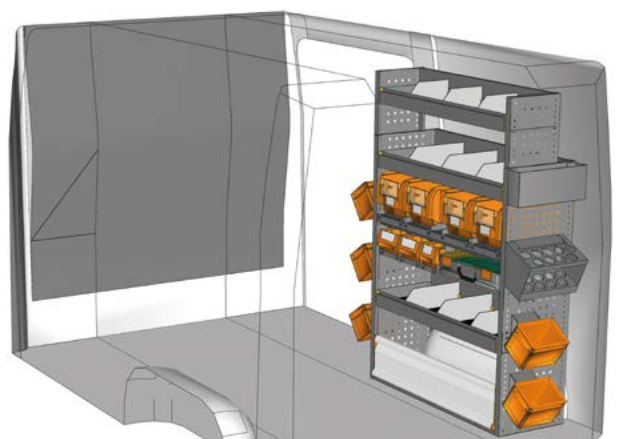

ESEMPIO - EXEMPLE

SP 1015 05*



L=1016 P=365 H=1500 mm

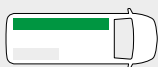

ESEMPI DI ALLESTIMENTO - EXEMPLES D'AMÉNAGEMENTS

ESEMPIO - EXEMPLE
SP 2215 07*

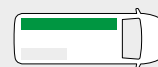
L=2241 P=365 H=1500 mm

ESEMPIO - EXEMPLE
SP 2215 08*

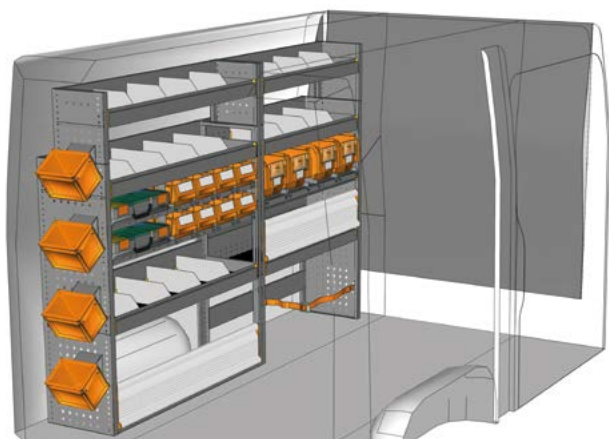
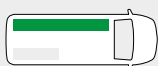
L=2241 P=365 H=1500 mm

ESEMPIO - EXEMPLE
SP 2215 09*

L=2241 P=365 H=1500 mm

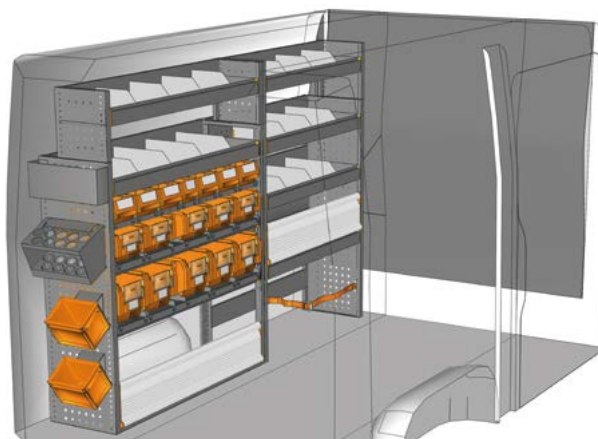
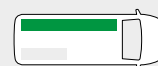
ESEMPIO - EXEMPLE
SP 2215 10*

L=2241 P=365 H=1500 mm

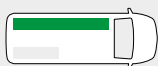
ESEMPIO - EXEMPLE
SP 2215 11*

L=2241 P=365 H=1500 mm

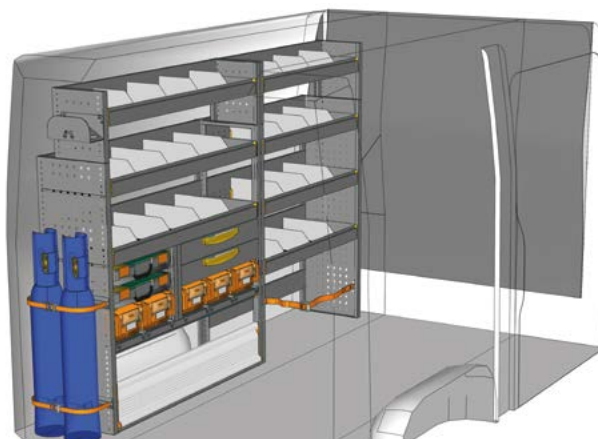
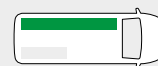
ESEMPIO - EXEMPLE
SP 2215 12*

L=2241 P=365 H=1500 mm



ESEMPIO DI ALLESTIMENTO - EXEMPLES D'AMÉNAGEMENTS

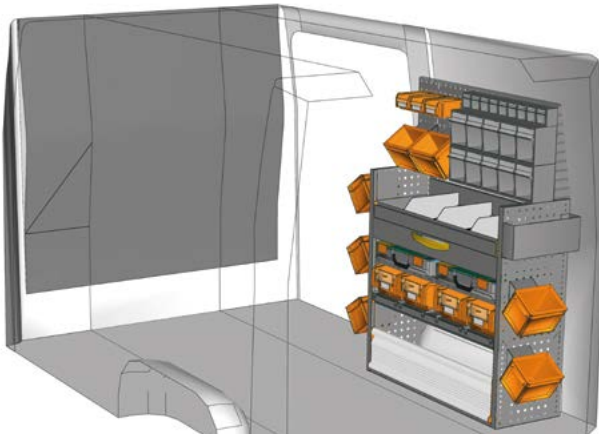

ESEMPIO - EXEMPLE

SP 1015 07*

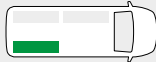

L=1016 P=365 H=1420 mm

**Non hai trovato il tuo allestimento?
Affidati ai nostri professionisti**

Guarda il retro di questo catalogo e
contatta il punto Store Van piu vicino
oppure visita il nostro sito.



**Vous n'avez pas trouvé votre
équipement ? Confiez-vous
à nos professionnels**

Voir au dos de ce catalogue
et contactez le point StoreVan
le plus proche ou visitez notre site web.

*** Kit fissaggio incluso - Jeu de fixation inclus**



ESEMPIO - EXEMPLE

SP 1015 08*

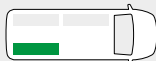

L=1016 P=365 H=1500 mm

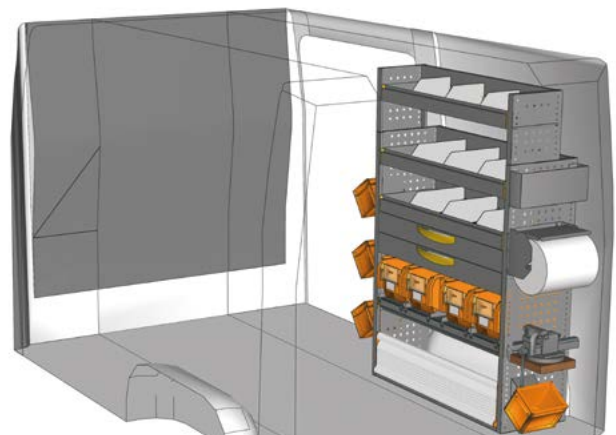

ESEMPIO - EXEMPLE

SP 1015 09*

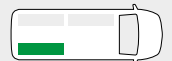

L=1016 P=365 H=1500 mm

Vista da porta laterale
Vue de porte latérale

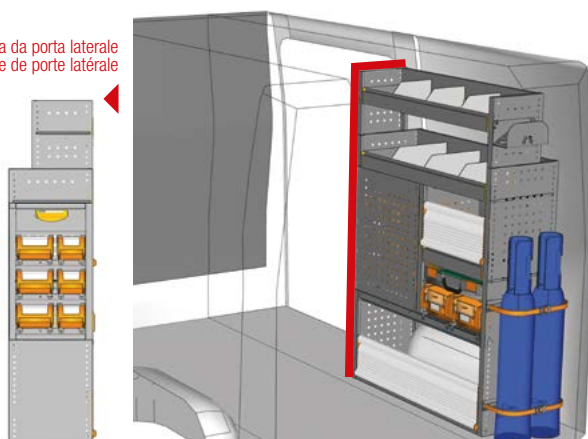

ESEMPIO - EXEMPLE

SP 1015 11*



L=1016 P=365 H=1500 mm

Vista da porta laterale
Vue de porte latérale

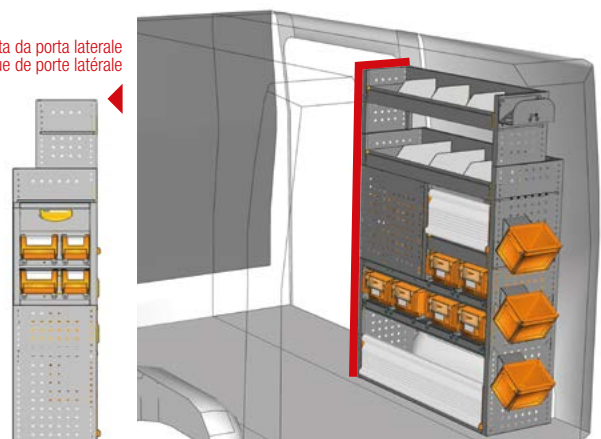

ESEMPIO - EXEMPLE

SP 1015 12*

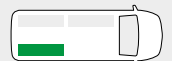

L=1016 P=365 H=1500 mm



ESEMPI DI ALLESTIMENTO - EXEMPLES D'AMÉNAGEMENTS

ESEMPIO - EXEMPLE
SP 2715 01*

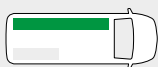
L=2749 P=365 H=1540 mm

ESEMPIO - EXEMPLE
SP 2715 02*

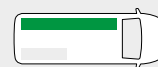
L=2749 P=365 H=1540 mm

ESEMPIO - EXEMPLE
SP 2715 03*

L=2749 P=365 H=1540 mm

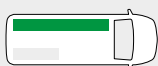
ESEMPIO - EXEMPLE
SP 2715 04*

L=2749 P=365 H=1540 mm

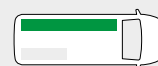
ESEMPIO - EXEMPLE
SP 2715 05*

L=2749 P=365 H=1540 mm

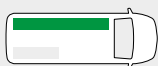

ESEMPIO - EXEMPLE
SP 2715 06*

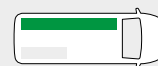
L=2749 P=365 H=1540 mm



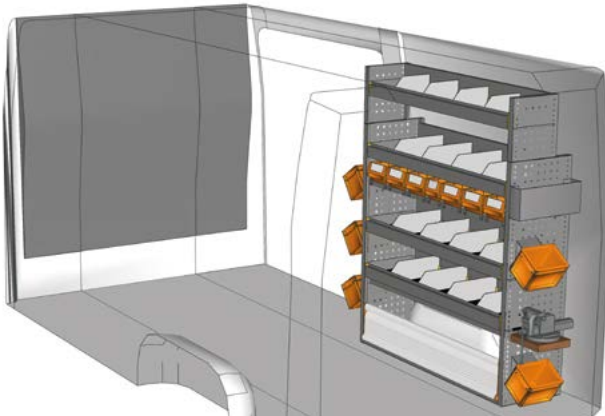

ESEMPI DI ALLESTIMENTO - EXEMPLES D'AMÉNAGEMENTS



ESEMPIO - EXEMPLE

SP 1215 01*

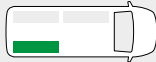

L=1225 P=365 H=1500 mm

**Non hai trovato il tuo allestimento?
Affidati ai nostri professionisti**

Guarda il retro di questo catalogo e
contatta il punto Store Van piu vicino
oppure visita il nostro sito.



**Vous n'avez pas trouvé votre
équipement ? Confiez-vous
à nos professionnels**

Voir au dos de ce catalogue
et contactez le point StoreVan
le plus proche ou visitez notre site web.

*** Kit fissaggio incluso - Jeu de fixation inclus**

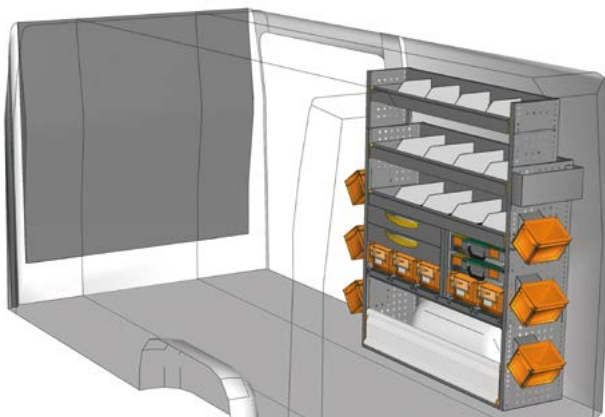

ESEMPIO - EXEMPLE

SP 1215 02*

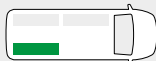

L=1225 P=365 H=1500 mm

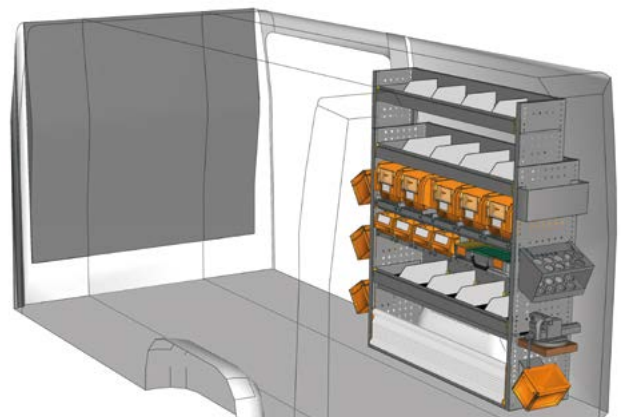

ESEMPIO - EXEMPLE

SP 1215 03*

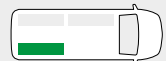

L=1225 P=365 H=1500 mm

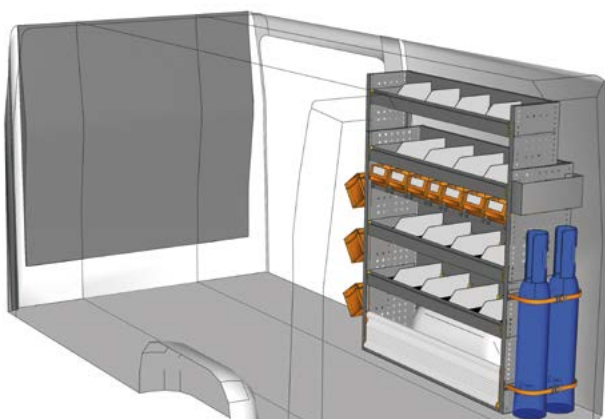

ESEMPIO - EXEMPLE

SP 1215 04*



L=1225 P=365 H=1500 mm

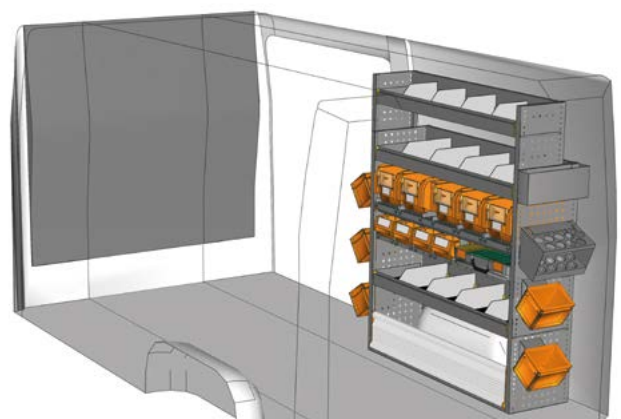

ESEMPIO - EXEMPLE

SP 1215 05*



L=1225 P=365 H=1500 mm

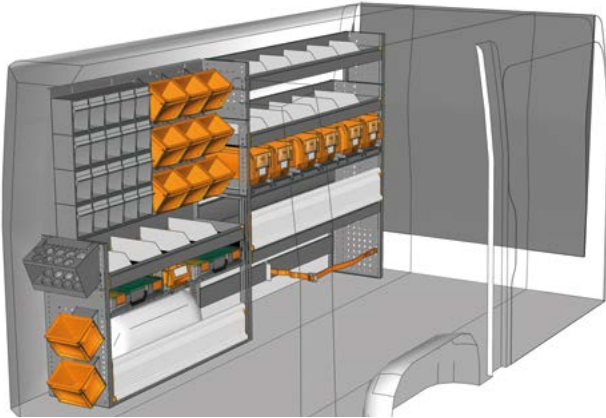
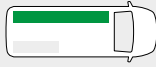

ESEMPIO DI ALLESTIMENTO - EXEMPLES D'AMÉNAGEMENTS

ESEMPIO - EXEMPLE
SP 2715 07*

L=2749 P=365 H=1500 mm

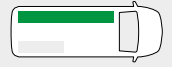
ESEMPIO - EXEMPLE
SP 2715 08*

L=2749 P=365 H=1500 mm

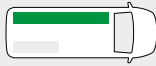
ESEMPIO - EXEMPLE
SP 2715 09*

L=2749 P=365 H=1500 mm

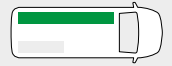
ESEMPIO - EXEMPLE
SP 2715 10*

L=2749 P=365 H=1500 mm

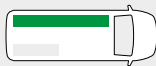
ESEMPIO - EXEMPLE
SP 2715 11*

L=2749 P=365 H=1500 mm

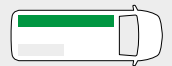
ESEMPIO - EXEMPLE
SP 2715 12*

L=2749 P=365 H=1500 mm



ESEMPI DI ALLESTIMENTO - EXEMPLES D'AMÉNAGEMENTS

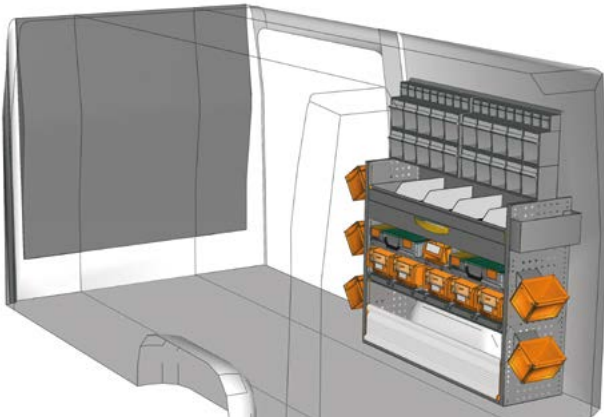

ESEMPIO - EXEMPLE

SP 1215 07*

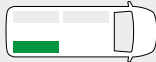

L=1225 P=365 H=1420 mm

**Non hai trovato il tuo allestimento?
Affidati ai nostri professionisti**

Guarda il retro di questo catalogo e
contatta il punto Store Van piu vicino
oppure visita il nostro sito.



**Vous n'avez pas trouvé votre
équipement ? Confiez-vous
à nos professionnels**

Voir au dos de ce catalogue
et contactez le point StoreVan
le plus proche ou visitez notre site web.

*** Kit fissaggio incluso - Jeu de fixation inclus**



ESEMPIO - EXEMPLE

SP 1215 08*



L=1225 P=365 H=1500 mm



ESEMPIO - EXEMPLE

SP 1215 09*

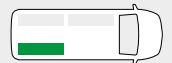

L=1225 P=365 H=1500 mm

Vista da porta laterale
Vue de porte latérale

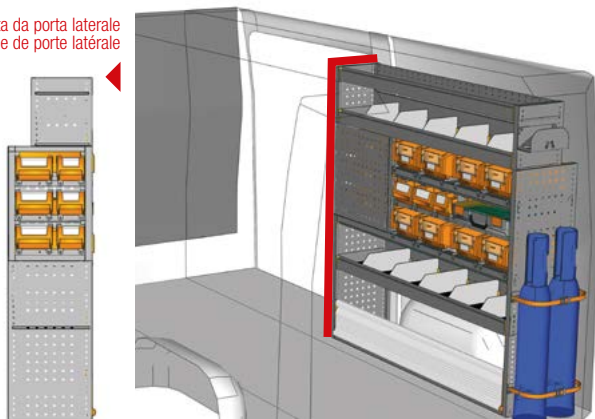

ESEMPIO - EXEMPLE

SP 1515 01*



L=1524 P=365 H=1500 mm

Vista da porta laterale
Vue de porte latérale

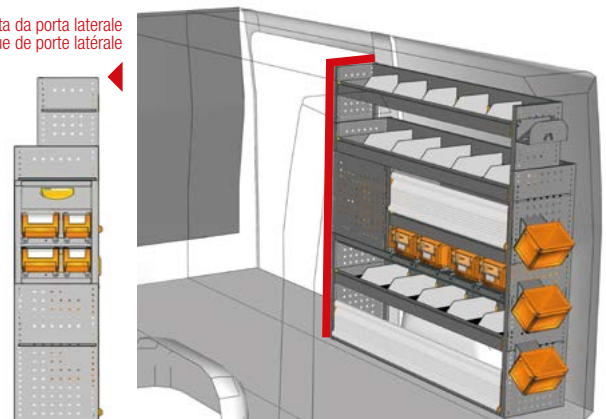

ESEMPIO - EXEMPLE

SP 1515 02*

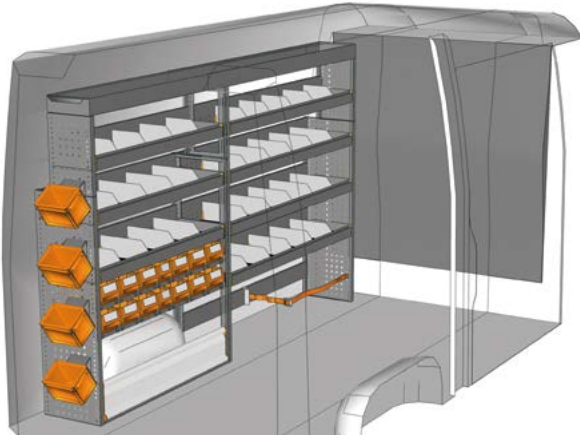

L=1524 P=365 H=1500 mm

ESEMPIO DI ALLESTIMENTO - EXEMPLES D'AMÉNAGEMENTS

ESEMPIO - EXEMPLE
SP 2717 01*

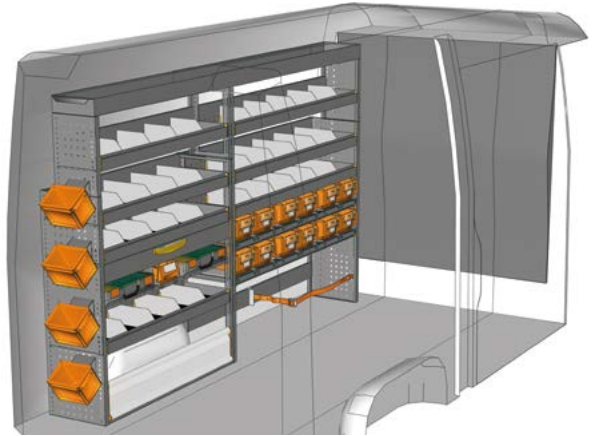
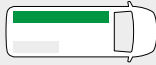
L=2749 P=365 H=1690 mm

ESEMPIO - EXEMPLE
SP 2717 02*

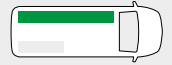
L=2749 P=365 H=1690 mm

ESEMPIO - EXEMPLE
SP 2717 03*

L=2749 P=365 H=1690 mm

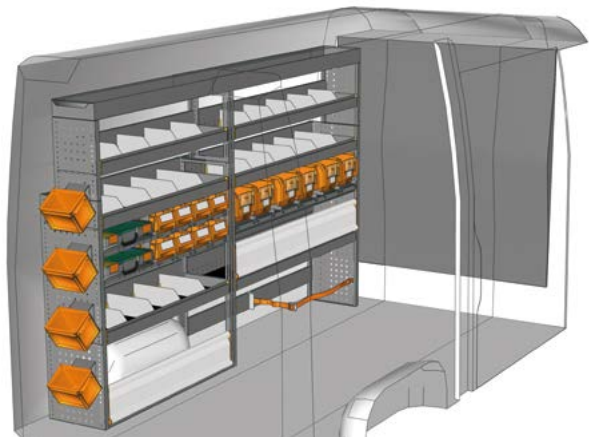
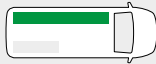
ESEMPIO - EXEMPLE
SP 2717 04*

L=2749 P=365 H=1690 mm

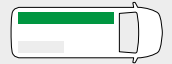
ESEMPIO - EXEMPLE
SP 2717 05*

L=2749 P=365 H=1690 mm

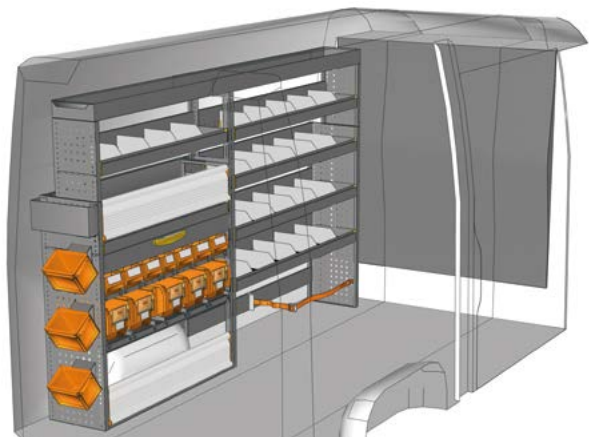
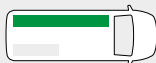
ESEMPIO - EXEMPLE
SP 2717 06*

L=2749 P=365 H=1690 mm

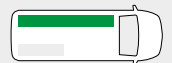



ESEMPIO DI ALLESTIMENTO - EXEMPLES D'AMÉNAGEMENTS



ESEMPIO - EXEMPLE

SP 1217 01*

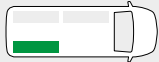

L=1225 P=365 H=1700 mm

**Non hai trovato il tuo allestimento?
Affidati ai nostri professionisti**

Guarda il retro di questo catalogo e
contatta il punto Store Van piu vicino
oppure visita il nostro sito.



**Vous n'avez pas trouvé votre
équipement ? Confiez-vous
à nos professionnels**

Voir au dos de ce catalogue
et contactez le point StoreVan
le plus proche ou visitez notre site web.

*** Kit fissaggio incluso - Jeu de fixation inclus**



ESEMPIO - EXEMPLE

SP 1217 02*

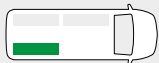

L=1225 P=365 H=1700 mm

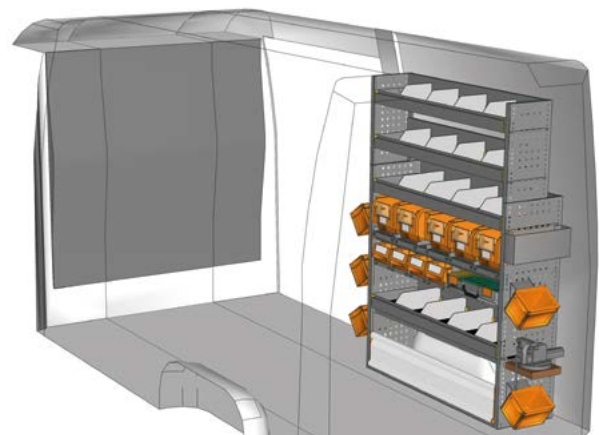

ESEMPIO - EXEMPLE

SP 1217 03*



L=1225 P=365 H=1700 mm



ESEMPIO - EXEMPLE

SP 1217 04*



L=1225 P=365 H=1700 mm



ESEMPIO - EXEMPLE

SP 1217 05*



L=1225 P=365 H=1700 mm



ESEMPI DI ALLESTIMENTO - EXEMPLES D'AMÉNAGEMENTS

ESEMPIO - EXEMPLE
SP 2717 07*

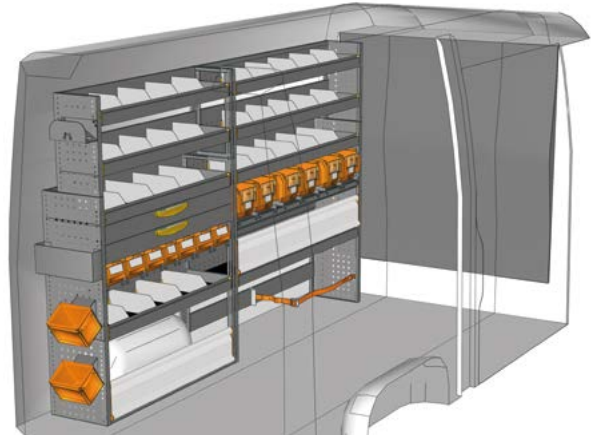
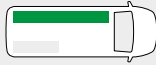
L=2749 P=365 H=1700 mm

ESEMPIO - EXEMPLE
SP 2717 08*

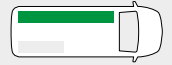
L=2749 P=365 H=1700 mm

ESEMPIO - EXEMPLE
SP 2717 09*

L=2749 P=365 H=1700 mm

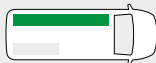
ESEMPIO - EXEMPLE
SP 2717 10*

L=2749 P=365 H=1700 mm

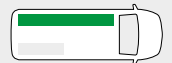
ESEMPIO - EXEMPLE
SP 2717 11*

L=2749 P=365 H=1700 mm

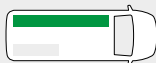

ESEMPIO - EXEMPLE
SP 2717 12*

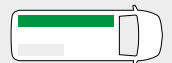
L=2749 P=365 H=1700 mm



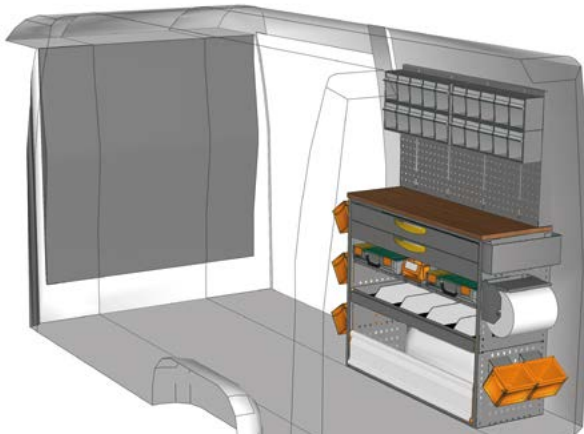

ESEMPIO DI ALLESTIMENTO - EXEMPLES D'AMÉNAGEMENTS



ESEMPIO - EXEMPLE

SP 1217 07*

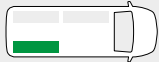

L=1225 P=445 H=1725 mm

**Non hai trovato il tuo allestimento?
Affidati ai nostri professionisti**

Guarda il retro di questo catalogo e
contatta il punto Store Van piu vicino
oppure visita il nostro sito.



**Vous n'avez pas trouvé votre
équipement ? Confiez-vous
à nos professionnels**

Voir au dos de ce catalogue
et contactez le point StoreVan
le plus proche ou visitez notre site web.

*** Kit fissaggio incluso - Jeu de fixation inclus**



ESEMPIO - EXEMPLE

SP 1217 08*

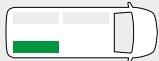

L=1225 P=365 H=1700 mm



ESEMPIO - EXEMPLE

SP 1217 09*



L=1225 P=365 H=1700 mm



ESEMPIO - EXEMPLE

SP 1517 01*



L=1524 P=365 H=1700 mm

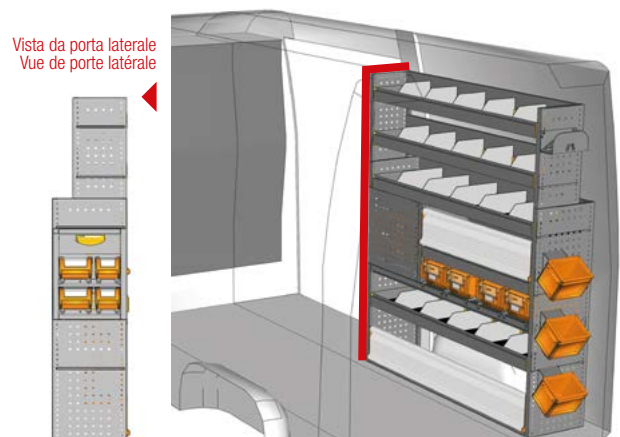

ESEMPIO - EXEMPLE

SP 1517 02*



L=1524 P=365 H=1700 mm



MERCEDES-BENZ SPRINTER

FURGONE LAMIERATO - FOURGON TÔLÉ

PORTATUTTO E PORTASCALE - GALERIE DE TOIT ET PORTE-ÉCHELLES



| VEICOLO VÉHICULE | PORTATUTTO GALERIE DE TOIT | DIMENSIONI DIMENSIONS | PESO POIDS | PORTATA CHARGE |
|--|-------------------------------|--------------------------|---------------|-------------------|
| | ART. | | | |
| Modello - Modèle L1 H1 Compact, Tetto Normale Court, Toit Normal | POT 107 | 2750x1700 mm | 29,28 kg | 170,00 kg |
| Modello - Modèle L1 H2 Compact, Tetto Alto Court, Toit Surélevé | POT 113 | 2750x1700 mm | 29,84 kg | 120,00 kg |
| Modello - Modèle L2 H1 Standard, Tetto Normale Moyen, Toit Normal | POT 108 | 3400x1700 mm | 31,70 kg | 168,00 kg |
| Modello - Modèle L2 H2 Standard, Tetto Alto Moyen, Toit Surélevé | POT 109 | 3400x1700 mm | 32,26 kg | 117,00 kg |
| Modello - Modèle L3 H2 Long, Tetto Alto Long, Toit Surélevé | POT 110 | 4350x1700 mm | 39,68 kg | 110,00 kg |
| Modello - Modèle L3L H2 Extralong, Tetto Alto Extra Long, Toit Surélevé | POT 111 | 4700x1700 mm | 44,76 kg | 105,00 kg |

POT

- Portatutto completo di:
 - barre in alluminio complete di attacchi e profilo in gomma
 - sponde laterali in alluminio
 - rullo di caricamento in alluminio
 - viterie di fissaggio fornite in acciaio inox
- Galerie de toit complète de :
 - barres en aluminium avec fixations et profil en caoutchouc
 - rebords latéraux en aluminium
 - rouleau de chargement en aluminium
 - visserie de fixation fournie en acier inox





PORTATUTTO E PORTASCALE - GALERIE DE TOIT ET PORTE-ÉCHELLES

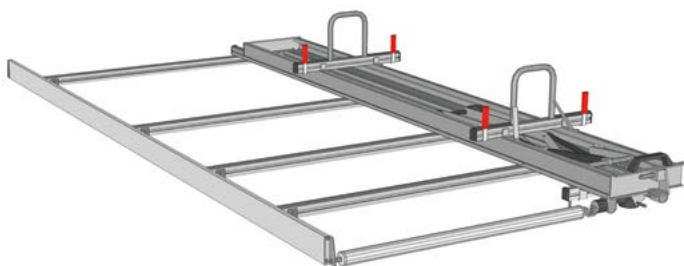

| VEICOLO VÉHICULE | PORTASCALE PORTE-ÉCHELLES | DIMENSIONI DIMENSIONS | PESO POIDS | PORTATA CHARGE |
|--|------------------------------|--------------------------|---------------|-------------------|
| | ART. | | | |
| Modello - Modèle L1 H1 Compact, Tetto Normale Court, Toit Normal | POS 107 | 2750x1680 mm | 58,22 kg | 142,00 kg |
| Modello - Modèle L1 H2 Compact, Tetto Alto Court, Toit Surélevé | POS 113 | 2750x1680 mm | 58,78 kg | 91,00 kg |
| Modello - Modèle L2 H1 Standard, Tetto Normale Moyen, Toit Normal | POS 108 | 3400x1680 mm | 62,33 kg | 137,00 kg |
| Modello - Modèle L2 H2 Standard, Tetto Alto Moyen, Toit Surélevé | POS 109 | 3400x1680 mm | 62,89 kg | 87,00 kg |
| Modello - Modèle L3 H2 Long, Tetto Alto Long, Toit Surélevé | POS 110 | 4350x1680 mm | 68,55 kg | 81,00 kg |
| Modello - Modèle L3L H2 Extralong, Tetto Alto Extra Long, Toit Surélevé | POS 111 | 4700x1680 mm | 73,10 kg | 77,00 kg |

POS

- Portascale completo di:
 - barre in alluminio complete di attacchi e profilo in gomma
 - sponda laterale in alluminio
 - rullo di caricamento in alluminio
 - slitta portascale in alluminio e acciaio inox
 - viterie di fissaggio fornite in acciaio inox
- Porte-échelles complet de :
 - barres en aluminium avec fixations et profil en caoutchouc
 - rebord latéral en aluminium
 - rouleau de chargement en aluminium
 - chariot porte-échelles en aluminium et acier inox
 - visserie de fixation fournie en acier inox

- La slitta portascale può essere montata a destra o a sinistra.
- Le chariot porte-échelles peut être monté à droite ou à gauche.

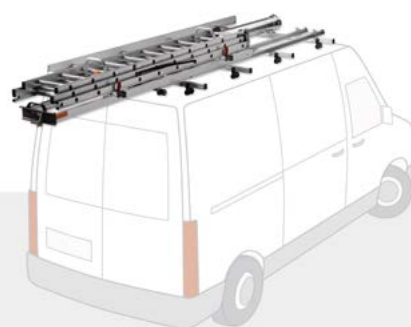
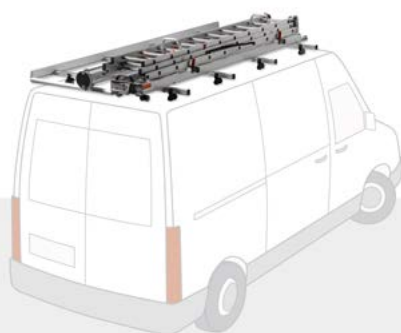

**ART. ACS 005**

- Porta rotoli di carta Ø 140 mm
- Dérouleur de papier et essuie-tout Ø 140 mm

**ART. ACS 012**

- Porta rotoli di carta Ø 240 mm
- Dérouleur de papier et essuie-tout Ø 240 mm

**ART. ACS 013**

- Kit porta silicone
- Kit porte silicone

**ART. ACS 014**

- Sella reggicavo
- Porte tuyaux et câbles

**ART. ACS 004**

- Kit pronto soccorso
- Trousse de premiers secours

**ART. ACS 006**

- Tasca porta documenti DIN A4
- Poche porte documents DIN A4

**ART. ACS 007**

- Porta bombolette
- Porte aérosol

**ART. ACS 015**

- Supporto con 1 contenitore misura 1 PL
- Support avec 1 bac mesure 1 PL

**ART. ACS 016**

- Supporto con 3 contenitori misura 1 PL
- Support avec 3 bacs mesure 1 PL

**ART. ACS 017**

- Supporto con cassetta misura 2115A
- Support avec caisse mesure 2115A

**ART. ACS 001**

- Kit lavamani
- Kit lave-mains

**ART. ACS 002**

- Kit porta tanica con tanica in ferro capacità 20 litri
- Jerrican en fer de 20 litres avec support jerrican

ACCESSORI - ACCESSOIRES

ART. ACS 003
A

- Supporto con cinghia per bombole ed estintori
- Support avec sangle pour bouteilles de gaz et extincteurs

ART. ACS 018
B

- Estintore 4 kg
- Extincteur 4 kg

ART. ACS 019
C

- Barra All Safe L= 365 mm e cinghia a cricchetto
- Barre All Safe L= 365 mm et sangle à cliquet

ART. ACS 020
C

- Barra All Safe L= 445 mm e cinghia a cricchetto
- Barre All Safe L= 445 mm et sangle à cliquet

ART. ACS 021
D

- Barra All Safe L= 365 mm e cinghia con morsetto
- Barre All Safe L= 365 mm et sangle avec crochet

ART. ACS 022
D

- Barra All Safe L= 445 mm e cinghia con morsetto
- Barre All Safe L= 445 mm et sangle avec crochet

 Esempio con 2 **ART. ACS 003**
 Exemple avec 2 **ART. ACS 003**

 Esempio con 2 **ART. ACS 019**
 Exemple avec 2 **ART. ACS 019**

 Esempio con 2 **ART. ACS 021**
 Exemple avec 2 **ART. ACS 021**

ART. ACS 023

- Set 10 calamite Ø 20 mm
- Kit de 10 aimants Ø 20 mm

ART. ACS 024

- Set 10 calamite Ø 25 mm
- Kit de 10 aimants Ø 25 mm

ART. ACS 025

- Lampada a led L=600 mm IP20 12V
- Lampe à LED L=600 mm IP20 12V

CONDIZIONI DI FORNITURA

- Piani e pannellature forniti in più pezzi.
- Portatutto e portascale vengono forniti **smontati**.
- I moduli vengono forniti **preassemblati** completi del materiale di ancoraggio al veicolo.
- Per l'installazione dei prodotti si consiglia di rivolgersi alla nostra rete di **installatori autorizzati**.
- I prodotti vengono forniti completi di **imballo**.
- **3 anni di garanzia** sui nostri prodotti.
- Le portate si riferiscono a **peso uniformemente distribuito**.

CONDITIONS DE FOURNITURE

- Planchers et habillages fournis en plusieurs éléments.
- Galeries de toit et porte-échelles sont fournis **démontés**.
- Les modules sont fournis **pré-montés**, avec le matériel de fixation au véhicule.
- Pour l'installation des produits, il est conseillé de s'adresser à notre réseau d'**installateurs agréés**.
- Les produits sont fournis **emballés**.
- **3 ans de garantie** sur nos produits.
- Les capacités de charge se réfèrent à **charge uniformément répartie**.

WWW.STOREVAN.COM



FAMI S.r.l.

Via Stazione Rossano, 13 | 36027 Rosà (VI) | ITALY
phone +39 0424 585455 | fax +39 0424 585482
www.famisp.com | info@famisp.com
www.storevan.com | info@storevan.com

