



FAHRZEUGEINRICHTUNGEN
FITTINGS FOR COMMERCIAL VEHICLES



NISSAN NV400





StoreVan ist weltweit der einzige Hersteller von Nutzfahrzeugeinrichtungen, der mit dieser Technologie arbeitet.

StoreVan is the sole LCV's equipment manufacturer worldwide to make use of this technology.

TECHNOLOGIE

GALVANNEALED STAHL

Galvannealed Blech ist eine Variante von feuerverzinktem Blech. Das Produkt unterliegt einem Feuerbeschichtungsprozess und wird bis ca. 550 °C erhitzt. Dies ermöglicht es dem Zink mit dem Stahlblech eine Legierung einzugehen. Das Ergebnis ist eine Beschichtung mit einer gleichförmigen, feinkörnigen Kristallstruktur an der Beschichtungsoberfläche und einer **sehr hohen Oberflächenqualität und Korrosionsbeständigkeit**.

Dieses Verfahren ist ideal für Automotive Anwendungen. StoreVan hat diese Technik nun auch im Bereich Nutzfahrzeugeinrichtungen implementiert.

DAS VERFAHREN DER KATHODISCHEN ACRYL-TAUCHLACKIERUNG

Die kathodische Acryl-Beschichtung ist eine Oberflächenbehandlung, die den einzelnen Teilen der Einrichtung eine **extrem hohe Korrosionsbeständigkeit** verleiht. Das Tauchverfahren gewährleistet eine **gleichmäßige Beschichtung** und einen lang anhaltenden Schutz egal gegen welche Stoffe. Das Acrylharz schützt den Lack bei direkter Belichtung durch die Witterung gegen Ausbleichen und gegen Veränderungen der Korrosionsbeständigkeit.

- Korrosionsbeständigkeit von über 500 Stunden (ASTM D1735 Luftfeuchtigkeit)
- Ausgezeichnete Härte mit einem Mindeststrating von 2H



STORE VAN ORANGE PLANET

Nachhaltigkeit und ökologische Entwicklung sind Themen von großem, aktuellem Interesse, entstanden durch das steigende Bewusstsein, dass auf die Umweltbalance aufgrund der zyklischen Veränderungen und Erneuerungen geachtet werden muss.

STORE VAN ORANGE PLANET

Environmental sustainability and eco-compatible development are topics of great interest and relevance, arising from the growing awareness that it is important to pay attention to the environmental balance.

TECHNOLOGIES

GALVANNEALED STEEL

Galvannealed sheet is a variant of hot-dip galvanized sheet. The product is subject to a hot-dip-galvanization process and subsequently heated to approximately 550°C, combining the zinc with the sheet surface to make an alloy with iron. The result is a uniform zinc coating with a fine-grained crystalline structure along with a **much higher surface quality and corrosion resistance**. This process is ideal for automotive applications. StoreVan has introduced and implemented this technology in the commercial vehicles equipment field.

CATHODIC DIP PAINTING WITH ACRYLIC RESIN

Cataphoresis painting is a paint surface treatment able to give the equipment elements a **remarkable resistance to corrosion**; characterized by **uniform deposit** of an acrylic resin on the element surface, it ensures long lasting, high protection against chemical agents and other types of surface attacks. The acrylic resin allows a direct exposure to atmospheric agents without altering its technical features. This process ensures an increased protection against rust.

- Corrosion resistance of more than 500 hours (humidity ASTM D1735)
- Excellent hardness with a minimum rating of 2H



FLEXIBLES BEFESTIGUNGSSYSTEM

FLEXIBLE FIXING SYSTEM

DIE FLEXIBILITÄT UND DAUERHAFTIGKEIT DER STORE VAN TRANSPORTEREINRICHTUNGEN

Store Van benutzt zur Befestigung der Transporterregale am Fahrgestell des Nutzfahrzeuges ein spezielles Schienensystem und sorgt damit für eine besonders flexible Positionierbarkeit der Module und eine maximale Nutzung der Innenräume des ausgestatteten Transporters.

Bei diesem System werden Bügel benutzt, die in der Gesamtlänge der Schiene gleiten, anstatt direkt an den Verstärkungen des Fahrgestells angenietet zu sein, was beim Entwurf der Transportereinrichtung grundsätzlich zu einer starren Raumnutzung zwingt. Die von Store Van verwendete Schiene wird an die vertikalen Pfosten der mobilen Werkstatt befestigt und hat die doppelte Funktion einer gleichmäßigen Verbindung der Transporterregale am Fahrzeugrahmen und einer homogenen Verteilung aller dynamischen Kräfte, denen die Einrichtung während der Fahrt ausgesetzt ist.

Die Befestigungsbügel für die Verbindung der Schiene am Modul besitzen ein spezielles Gelenk, das die bei der Fahrt verursachten Vibrationen dämpft, indem es sich den Torsionsbewegungen des Fahrgestells anpasst, vor allem beim Kurvenfahren.

Dieses System bietet beim Entwurf unserer Transportereinrichtungen eine erhebliche Gestaltungsfreiheit, wobei in jedem Fall hohe Sicherheits-, Stabilitäts- und Dauerhaftigkeitsstandards garantiert werden.

Bei allen unseren Befestigungssystemen können für die Module Schnellankupplungs- und -loskupplungssysteme mit Feststellgriffen eingesetzt werden, die eine werkzeuglose Demontage der Einrichtung ermöglichen. Dadurch kann das Regal Ihrer mobilen Werkstatt, wie in der RICHTLINIE 2014/47 EU, KAP. 1, Artikel 3, Absatz 5 beschrieben, als transportiertes Material oder als Hilfsmittel für die Sicherheit der nicht dauerhaft am Fahrzeug befestigten Ladung erklärt werden.

FLEXIBILITY AND DURABILITY OF STORE VAN EQUIPMENT

Store Van uses a special rail anchoring system to secure shelving units for vans to the chassis of your vehicle, improving the flexibility of module arrangement and maximising the internal spaces of your van.

This system is based on brackets sliding all along the rail rather than being riveted to chassis reinforcements, thus offering great flexibility in the management of internal spaces. The Store Van rail is secured to the uprights of your mobile workshop and has a two-fold function: it connects shelving units uniformly to the frame of your vehicle, and it evenly distributes all the dynamic forces your van equipment is subject to while travelling.

Special vibration damping joints, fitted on the brackets connecting the rail to the module, absorb the torsional vibration applied on the chassis especially when driving on a curve.

Thanks to this system, our fittings for vans can be designed with maximum freedom, always ensuring high safety, stability and durability standards.

Our anchoring systems are fitted with quick locking/unlocking devices with adjustable handles, so users can remove the fittings with no need of tools. Hence the shelving units of your mobile workshop may be considered as transported goods or load securing fittings not permanently fixed to the vehicle, in compliance with Directive 2014/47EU, Chapter 1, Article 3, Item 5.



ZERTIFIZIERUNGEN CERTIFICATIONS

ZERTIFIZIERTE PRODUKTION

- Nach ISO 9001:2015 zertifiziert.
- Erfolgreicher CRASH TEST durchgeführt nach ECE-R17 mit einer Aufprallgeschwindigkeit von 50 Km/h.
- GS-Zertifizierung für Inneneinrichtungen und Laderampen.
- GS-Zertifizierung für Dachträger und Leiterträger.

CERTIFIED PRODUCTION

- ISO 9001:2015 certified.
- Brilliantly passed the CRASH TEST carried out according to the most recent European regulations ECE-R17 with impact at 50 Km/h.
- GS certification for interior fittings and loading ramps.
- GS certification for roof and ladder racks.

CRASH TEST
ECE-R17



Die Grundlage für den sicheren Schutz von Fahrzeugen

The basis for the safe
protection of vehicles



LADUNGSSICHERUNG FÜR TRANSPORTER UND SICHERE BEFESTIGUNG DER WAREN

Durch die Umsetzung der Richtlinie 2014/47/EU wird eine Intensivierung der Kontrollen an Kraftfahrzeugen für die Güterbeförderung der Klassen N2 und N3 und eine aufmerksamere Kontrolle der Ladungssicherung erfolgen. Die Richtlinie ermöglicht es den Mitgliedsstaaten, Fahrzeuge, die über den Anwendungsbereich hinausgehen, wie z.B. Nutzfahrzeuge der Klasse N1, technischen Kontrollen zu unterziehen, sowie weitere Aspekte des Transports und der Straßenverkehrssicherheit zu kontrollieren.

SCHUTZSYSTEM DES LADERAUMS UND LADUNGSSICHERUNG

Das neue integrierte Transporter-Schutzsystem von Store Van folgt den Leitlinien der neuen Richtlinie 2014/47/EU und erlaubt eine **flexible und sichere Befestigung** der Ladung an den Ladeflächen und Innenwänden des Fahrzeugs.

Mit den „Airline“ Festhaltekomponenten und dem Einbau zahlreicher Zubehörteile wie Riemen, Netze und teleskopische Spannstrangen kann der Fahrzeugbenutzer seine Festhalteplattform einfach, ergonomisch und in Entsprechung der europäischen Richtlinien gestalten.

Das System umfasst die folgenden Bestandteile:

- Mehrschichtige Bodenplatten für Transporter mit Phenolharzverleimung, mit eingelassenen Aufnahmen für die Originalverankerungen des Fahrzeugs und mit zusätzlichen bodenplattenflächigen Verankerungen (S. 10) mit einer Zugkraft von 200 daN;
- am Fahrgestell verankerte „Airline“ Aluminiumschienen (S. 11);
- hochflexible und hochresistente Polypropylenpaneele für den internen Schutz der Karosserie vor Stößen (S. 8).

DAS ANBRINGEN DES NEUEN SCHUTZSETS SORGT FÜR EINE LANGE REIHE VON VORTEILEN:

- Der Fahrzeugbenutzer kann die Ladung schon mit den Zurrgurten sicher an den „Airline“ Schienen befestigen.
- Das integrierte Befestigungsset hält die Karosserie länger in gutem Zustand.
- Das Schutzsystem verleiht einen Mehrwert, der schon auf dem Markt der Neufahrzeuge sehr wichtig erscheint und bei Gebrauchtfahrzeugen, die normalerweise Karosserieschäden aufweisen, sogar von grundlegender Bedeutung ist.



VAN LOAD SECURING AND CARGO RESTRAINT

Transposition of directive 2014/47/EU will intensify control of N2 and N3 category transport vehicles and cargo securement enforcement. Under this Directive, the Member States can subject vehicles that are beyond the scope of the Directive, such as N1 category vehicles, to technical inspections, and also monitor other transport and road safety aspects.

CARGO AREA PROTECTION SYSTEM AND CARGO RESTRAINT

The new Store Van integrated system for van protection follows the guidelines of Directive 2014/47/EU while making the **anchoring of the cargo to the van floor and walls flexible and safe.**

With the use of „Airline“ securing components and integration of many different accessories such as belts, nets and telescopic load restraining bars, final users may configure their cargo platform easily and cheaply and in conformity with the European Directive.

The system uses:

- phenolic resin plywood floor panels, arranged to fit original anchoring fittings and additional 200 daN strength anchor points (page 10), flush with the floor panel;
- aluminium „Airline“ bars anchored to the chassis (page 11);
- highly flexible and resistant polypropylene panelling to protect the internal body shell from accidental impacts (page 8).

THE NEW LOAD SECURING SYSTEM OFFERS NUMEROUS ADVANTAGES:

- users can safely secure the load to the „Airline“ bars with load restraining belts;
- the integrated load securing system extends the body's good condition over the time;
- the protection system offers new added value, an important economic aspect for a new vehicle and a fundamental characteristic for a second-hand vehicle, that is usually exposed to damage.

SAFETY CROSS: Fixierpunkte in Längs- und Querrichtung nach Anfrage.
SAFETY CROSS: longitudinal and transversal fixing points upon request.

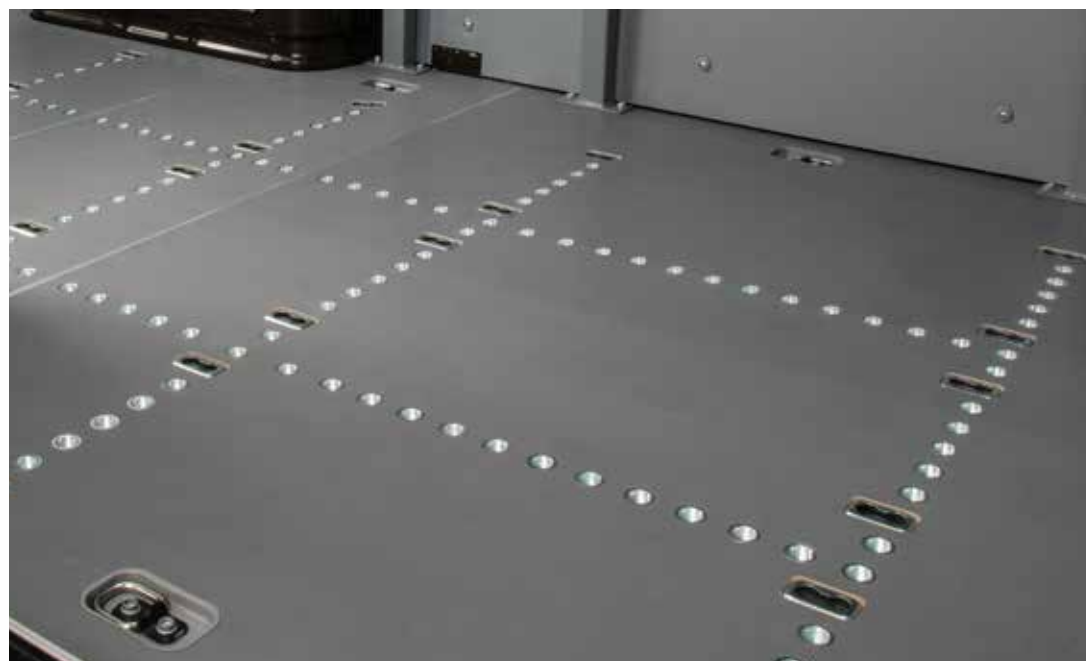



- Seitenverkleidungen für Fahrzeug mit rechter Schiebetür und Seitenwänden aus Vollblech.
- Linings for right side door vehicle with metal sheet sidewalls.

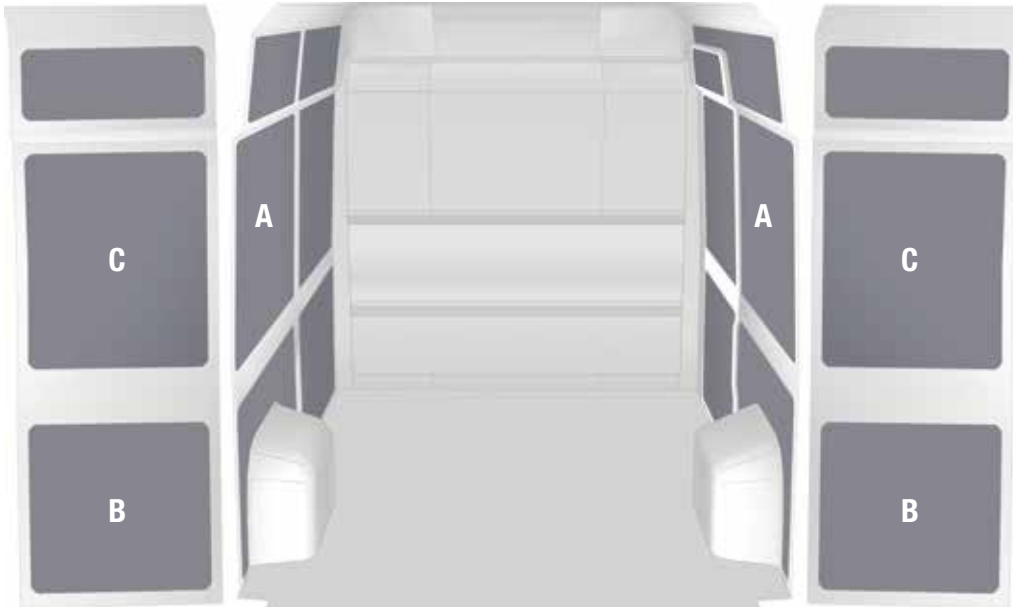

HONEYCOMB PANEL - A

- Seitenverkleidung aus Polypropylen für:
 - linke Seitenwand
 - rechte Seitenwand und Schiebetür
- Polypropylene linings for:
 - LH sidewall
 - RH sidewall and sliding door

HONEYCOMB PANEL - B

- Seitenverkleidung aus Polypropylen für:
 - unteren Teil der Heckflügeltüren
- Polypropylene linings for:
 - lower part of rear hinged doors

HONEYCOMB PANEL - C

- Seitenverkleidung aus Polypropylen für:
 - oberen Teil der Heckflügeltüren
- Polypropylene linings for:
 - upper part of rear hinged doors

FAHRZEUG VEHICLE	SEITENVERKLEIDUNG LINING	
	A+B	C
	ART. NR. / ITEM NO.	ART. NR. / ITEM NO.
Fahrzeugtyp - Model L1 H1 ^A	MA 10H1 A0 13,00 kg	MA DRH1 A0 2,13 kg
Fahrzeugtyp - Model L1 H2 ^A	MA 10H2 A0 14,39 kg	MA DRH2 A0 2,65 kg
Fahrzeugtyp - Model L2 H2/H3 ^A	MA 20H2 A0 17,91 kg	MA DRH2 A0 2,65 kg
Fahrzeugtyp - Model L3 H2/H3 ^A	MA 30H2 A0 20,24 kg	MA DRH2 A0 2,65 kg
Fahrzeugtyp - Model L3 H2/H3 ^B	MA 2LH2 J0 19,54 kg	MA DRH2 A0 2,65 kg
Fahrzeugtyp - Model L3 H2/H3 ^C	MA 2LH2 J0 19,54 kg	MA DRH2 A0 2,65 kg
Fahrzeugtyp - Model L4 H2/H3 ^B	MA 3LH2 J0 27,08 kg	MA DRH2 A0 2,65 kg
Fahrzeugtyp - Model L4 H2/H3 ^C	MA 3LH2 J0 27,08 kg	MA DRH2 A0 2,65 kg



^A Frontantrieb, Einzelbereifung
Front-wheel drive, single wheels

^B Heckantrieb, Einzelbereifung
Rear-wheel drive, single wheels

^C Heckantrieb, Zwillingsbereifung
Rear-wheel drive, twin wheels





- Bodenplatte für Fahrzeug mit rechter Schiebetür und Seitenwänden aus Vollblech.
- Flooring for right side door vehicle with metal sheet sidewalls.

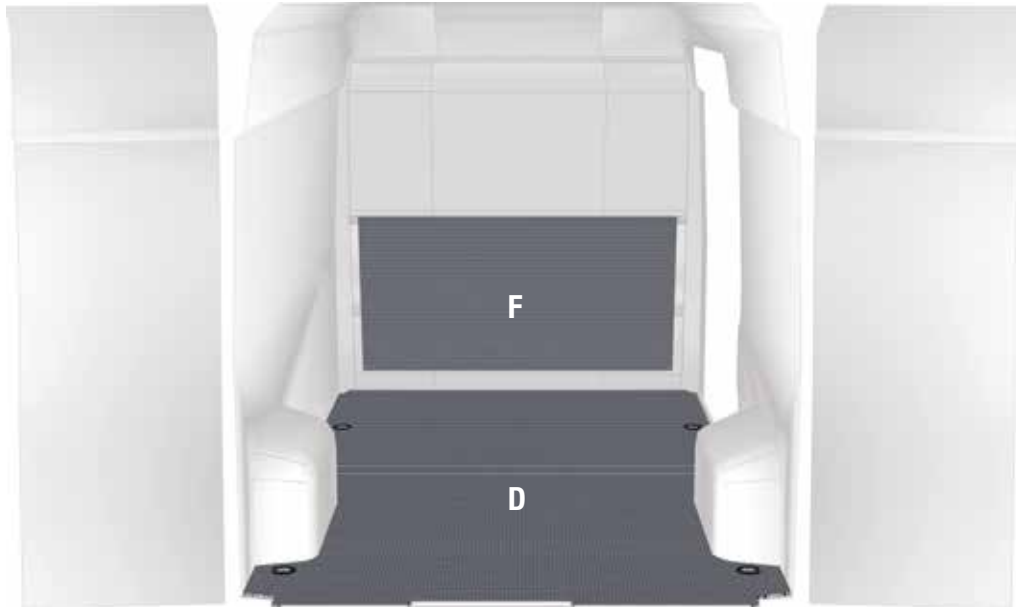

WOOD FLOOR - D

- Bodenplatte aus Multiplex mit Phenolbeschichtung, Stärke 9/12 mm, für das Originalverankerungssystem des Fahrzeugs vorgebohrt.
- 9/12 mm thick wooden flooring with phenolic coating set for the vehicle original anchoring system

WOOD FLOOR - F

- Kabinenrückwandplatte aus Multiplex mit Phenolbeschichtung, Stärke 12 mm
- 12 mm thick wooden bulkhead panel with phenolic coating

KASTENWAGEN - PANEL VAN
NISSAN NV400

WF

FAHRZEUG VEHICLE	BODENPLATTE 9 mm 9 mm FLOORING	BODENPLATTE 12 mm 12 mm FLOORING	RÜCKWANDPLATTE BULKHEAD
	D	D	F [1590x740x12 mm]
	ART. NR. / ITEM NO.	ART. NR. / ITEM NO.	ART. NR. / ITEM NO.
Fahrzeugtyp - Model L1 ^A	MA 10D1 AO 27,83 kg	MA 10T1 AO 34,75 kg	MA WBT1 AO 9,79 kg
Fahrzeugtyp - Model L2 ^A	MA 20D1 AO 33,88 kg	MA 20T1 AO 42,24 kg	MA WBT1 AO 9,79 kg
Fahrzeugtyp - Model L3 ^A	MA 30D1 AO 41,94 kg	MA 30T1 AO 52,21 kg	MA WBT1 AO 9,79 kg
Fahrzeugtyp - Model L3 ^B	MA 2LD1 JO 40,16 kg	MA 2LT1 JO 49,98 kg	MA WBT1 AO 9,79 kg
Fahrzeugtyp - Model L3 ^C	MA 2LD1 SO 38,38 kg	MA 2LT1 SO 47,78 kg	MA WBT1 AO 9,79 kg
Fahrzeugtyp - Model L4 ^B	MA 3LD1 JO 45,85 kg	MA 3LT1 JO 57,19 kg	MA WBT1 AO 9,79 kg
Fahrzeugtyp - Model L4 ^C	MA 3LD1 SO 45,73 kg	MA 3LT1 SO 57,09 kg	MA WBT1 AO 9,79 kg



^A Frontantrieb, Einzelbereifung - Front-wheel drive, single wheels
^B Heckantrieb, Einzelbereifung - Rear-wheel drive, single wheels
^C Heckantrieb, Zwillingsbereifung - Rear-wheel drive, twin wheels

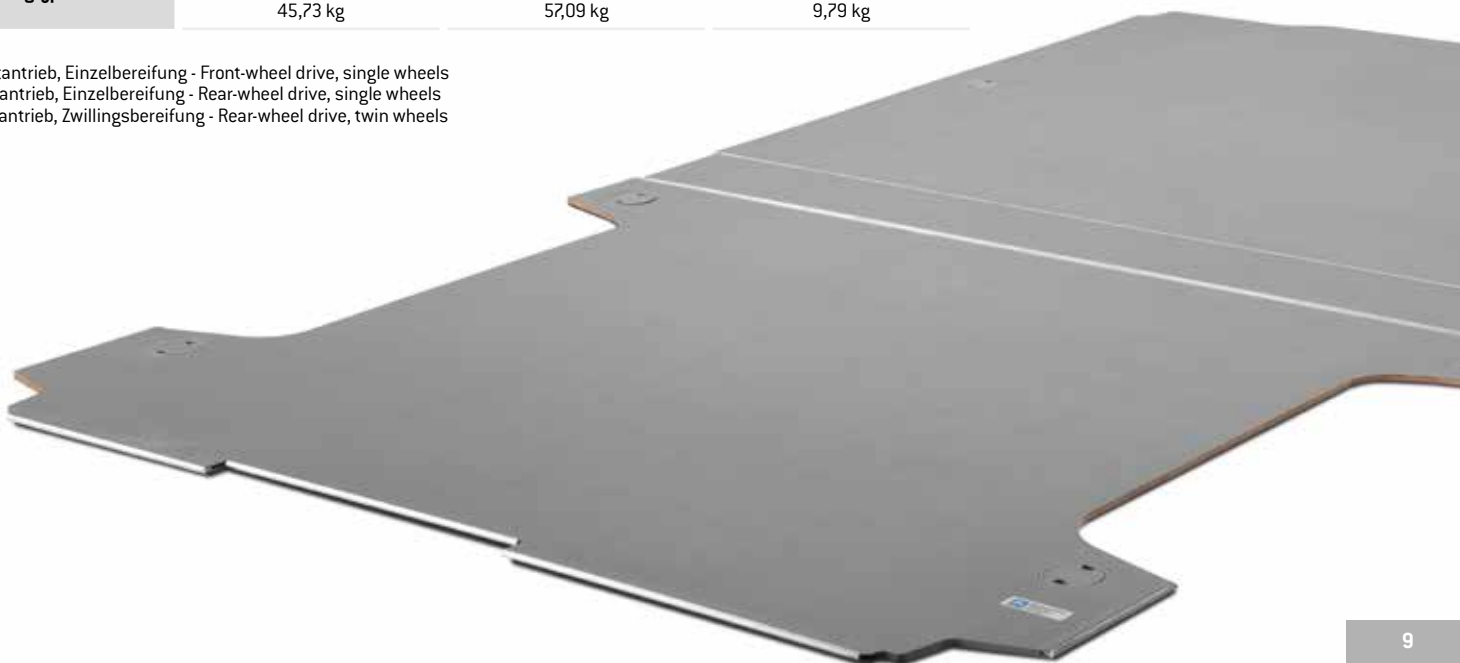



- Bodenplatte für Fahrzeug mit rechter Schiebetür und Seitenwänden aus Vollblech.
- Flooring for right side door vehicle with metal sheet sidewalls.

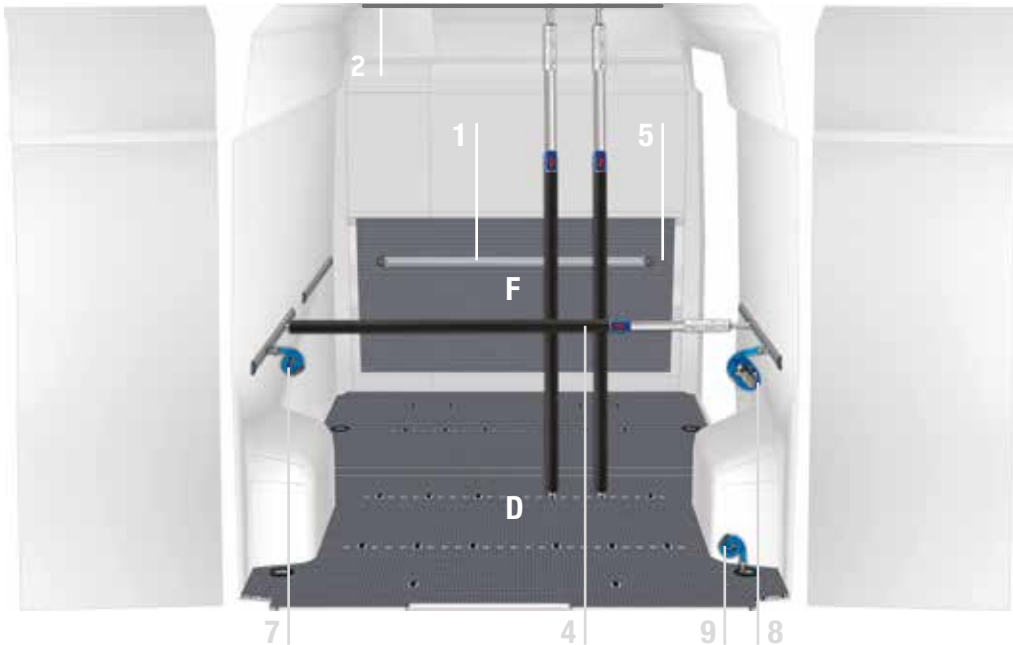

SAFETY FLOOR - D

- Bodenplatte 9 mm aus phenolbeschichtetem Holz mit zusätzlichem Einzelzurrpunktensystem.
- 9 mm phenol faced plywood flooring with additional lashing points

WOOD FLOOR - F

- Kabinenrückwandplatte aus Multiplex mit Phenolbeschichtung, Stärke 12 mm
- 12 mm thick wooden bulkhead panel with phenolic coating

FAHRZEUG VEHICLE	BODENPLATTE 9 mm FLOORING 9 mm	RÜCKWANDPLATTE BULKHEAD
	D	F (1590x740x12 mm)
	ART. NR. / ITEM NO.	ART. NR. / ITEM NO.
Fahrzeugtyp - Model L1 ^A	MA 10G1 A0 31,44 kg	MA WBT1 A0 9,79 kg
Fahrzeugtyp - Model L2 ^A	MA 20G1 A0 37,47 kg	MA WBT1 A0 9,79 kg
Fahrzeugtyp - Model L3 ^A	MA 30G1 A0 46,45 kg	MA WBT1 A0 9,79 kg
Fahrzeugtyp - Model L3 ^B	MA 2LG1 JO 42,66 kg	MA WBT1 A0 9,79 kg
Fahrzeugtyp - Model L3 ^C	MA 2LG1 SO 42,56 kg	MA WBT1 A0 9,79 kg

^A Frontantrieb, Einzelbereifung - Front-wheel drive, single wheels

^B Heckantrieb, Einzelbereifung - Rear-wheel drive, single wheels

^C Heckantrieb, Zwillingsbereifung - Rear-wheel drive, twin wheels

⚠ Die Bodenplatte muss auf den Fahrzeugboden aufgeklebt sein.
The floor must be glued to the vehicle



- Silikonklebstoff für Bodenplatten.
- Silicone glue for flooring.

ART. NR. / ITEM NO. **V22585**



- Horizontale Aluschiene.
- Horizontal aluminium bar.

1

ART. NR. / ITEM NO.	Länge - Length
V18029 05	500 mm
V18029 10	1000 mm
V18029 15	1500 mm
V18029 20	2000 mm
V18029 25	2500 mm



- Horizontale Aluschiene.
- Horizontal aluminium bar.

2

ART. NR. / ITEM NO.	Länge - Length
V18025 05	500 mm
V18025 10	1000 mm
V18025 15	1500 mm
V18025 20	2000 mm



- Horizontale Aluschiene.
- Horizontal aluminium bar.

3

ART. NR. / ITEM NO.	Länge - Length
V18030 10	1000 mm
V18030 15	1500 mm
V18030 20	2000 mm
V18030 25	2500 mm
V18030 30	3000 mm



- Teleskopische Spannstange.
- Telescopic load restraining bar.

4

ART. NR. / ITEM NO.	Länge - Length
V22149	650-900 mm
V22734	850-1100 mm
V22735	1050-1300 mm
V22131	1250-1750 mm
V22017	1550-2050 mm
V22086	2000-2500 mm



- Endstück aus Kunststoff für Aluschiene Serie V18029.
- Plastic end cap for bar series V18029.

5

ART. NR. / ITEM NO. **V22106**



- Zurring.
- Ring stud fitting.

6

ART. NR. / ITEM NO. **V225820**



- Zurrurt mit Hebelspannschloss 2500+500.
- Load restraining belt with clamp 2500+500.

7

ART. NR. / ITEM NO. **V22136**



- Zurrurt mit Ratschenschloss 2280+420.
- Load restraining belt with ratchet 2280+420.

8

ART. NR. / ITEM NO. **V22124**



- Zurrurt mit Ratschenschloss 4500+500.
- Load restraining belt with ratchet 4500+500.

9

ART. NR. / ITEM NO. **V22148**



- Beispiel von Ladungssicherungskoffer-kit.
- Example of tool case for load securing.



1 ART. NR. / ITEM NO.
BOX080

B=440 T=350 H=80 mm
W=440 D=350 H=80 mm



2 ART. NR. / ITEM NO.
V22136



2 ART. NR. / ITEM NO.
V22124



1 ART. NR. / ITEM NO.
CPV080



1 ART. NR. / ITEM NO.
YELLOW



2 ART. NR. / ITEM NO.
V22148



4 ART. NR. / ITEM NO.
V225820

Für weitere Informationen fordern Sie bitte unseren ‚Ladungssicherung‘ - Katalog an

For more information, ask for our „Load Securing“ catalogue



BESTANDTEILELISTE SEITENWANDVERKLEIDUNGEN - LININGS LEGEND

NISSAN NV400
KASTENWAGEN - PANEL VAN

HP
HONEYCOMB
PANEL

- Für Fahrzeug mit rechter Schiebetür und Seitenwänden aus Vollblech.
- For right side door vehicle with metal sheet sidewalls.

Fahrzeugtyp - Model
L1 H1^A

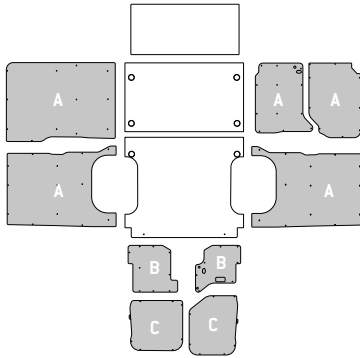

Fahrzeugtyp - Model
L1 H2^A

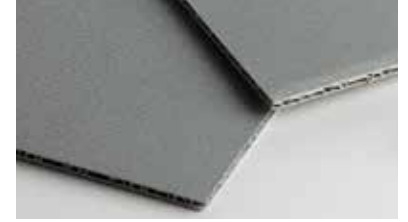
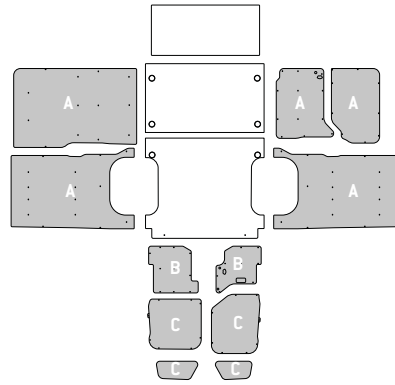

- A** Frontantrieb, Einzelbereifung
Front-wheel drive, single wheels
- B** Heckantrieb, Einzelbereifung
Rear-wheel drive, single wheels
- C** Heckantrieb, Zwillingsbereifung
Rear-wheel drive, twin wheels

Fahrzeugtyp - Model
L2 H2/H3^A

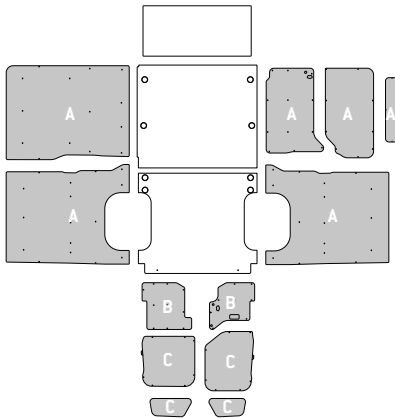

Fahrzeugtyp - Model
L3 H2/H3^A

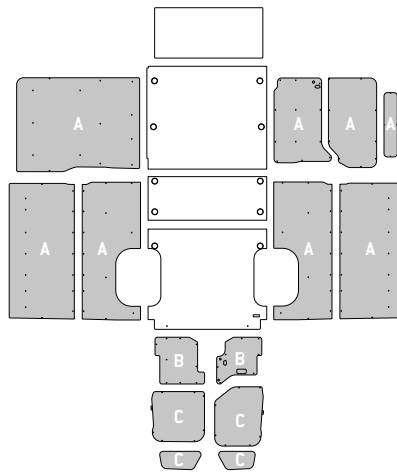

Fahrzeugtyp - Model
L3 H2/H3^B

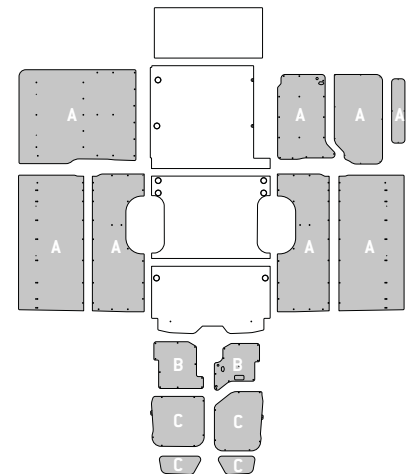

Fahrzeugtyp - Model
L3 H2/H3^C

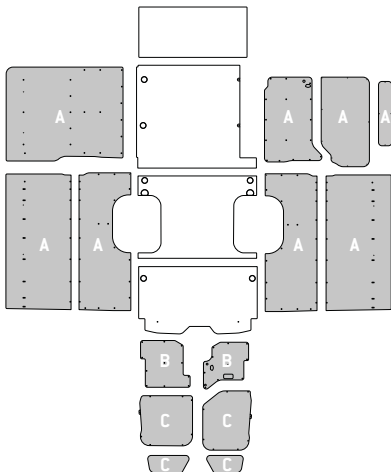

Fahrzeugtyp - Model
L4 H2/H3^B

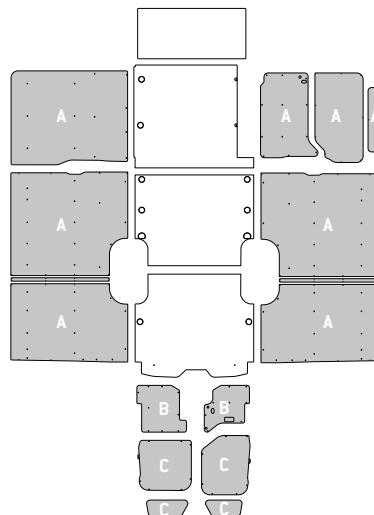

Fahrzeugtyp - Model
L4 H2/H3^C

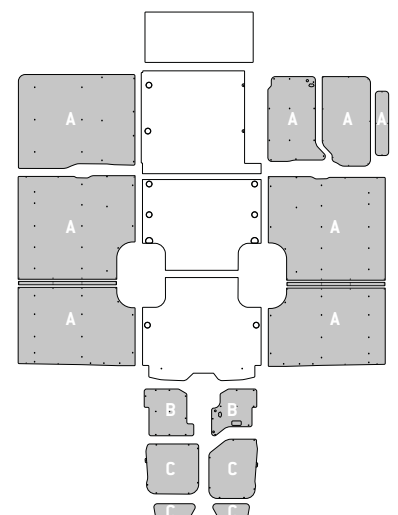

BESTANDTEILELISTE BODENPLATTE - FLOORING LEGEND



- Für Fahrzeug mit rechter Schiebetür und Seitenwänden aus Vollblech.
- For right side door vehicle with metal sheet sidewalls.

Fahrzeugtyp - Model L1 ^A	Fahrzeugtyp - Model L2 ^A	Fahrzeugtyp - Model L3 ^A	Fahrzeugtyp - Model L3 ^B	Fahrzeugtyp - Model L3 ^C	Fahrzeugtyp - Model L4 ^B	Fahrzeugtyp - Model L4 ^C

- ^A Frontantrieb, Einzelbereifung - Front-wheel drive, single wheels
- ^B Heckantrieb, Einzelbereifung - Rear-wheel drive, single wheels
- ^C Heckantrieb, Zwillingsbereifung - Rear-wheel drive, twin wheels

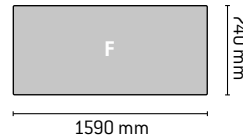

- Kabinenrückwandplatte.
- Bulkhead panel

KASTENWAGEN - PANEL VAN
NISSAN NV400

WOOD
FLOOR
WF

- Für Fahrzeug mit rechter Schiebetür und Seitenwänden aus Vollblech.
- For right side door vehicle with metal sheet sidewalls.

Fahrzeugtyp - Model L1 ^A	Fahrzeugtyp - Model L2 ^A	Fahrzeugtyp - Model L3 ^A	Fahrzeugtyp - Model L3 ^B	Fahrzeugtyp - Model L3 ^C



L1^A - L2^A - L3^A

- Jede Reihe von Verankerungspunkten für jede Bodenplatte besteht aus 6 "Airline" Einzelzurrpunkten und 19 Fixierspunkten für „Airline“ Sperrstangen.

- In each flooring, each lashing row is composed of 6 "Airline" lashing points and 19 fixing points for "Airline" shoring bars



L3^B - L3^C

- Jede Reihe von Verankerungspunkten für jede Bodenplatte besteht aus 6 "Airline" Einzelzurrpunkten und 12 Fixierspunkten für „Airline“ Sperrstangen.

- In each flooring, each lashing row is composed of 6 "Airline" lashing points and 12 fixing points for "Airline" shoring bars

- ^A Frontantrieb, Einzelbereifung - Front-wheel drive, single wheels
- ^B Heckantrieb, Einzelbereifung - Rear-wheel drive, single wheels
- ^C Heckantrieb, Zwillingsbereifung - Rear-wheel drive, twin wheels

SAFETY
FLOOR

SF



**Serienmäßig mit
Ladungssicherung**

Factory-fitted load
securing



Die Lösungen der **SAFETY Transportereinrichtungen** von Store Van erfüllen die Erfordernisse der neuen Ladungssicherungsbestimmungen. In die Module werden Strukturelemente eingebaut, die eine Nutzung der „Airline“ Festhaltesysteme wie Gurte, Netze und teleskopische Spannstangen erlauben. Dieses neue Niveau der **Einrichtungen für Nutzfahrzeuge** erleichtert das Verankern von mittelgroßen und kleinen Gegenständen, selbst wenn die Transporter-Bodenplatten nicht mit Verankerungssystemen ausgestattet sind, und garantiert dadurch die Ladungssicherung. Die „Airline“ Verankerungselemente des SAFETY-Niveaus erhöhen die Stabilität der Module ohne Gewichtszunahme, denn sie in der Struktur der Einrichtung integriert sind.

The Store Van **SAFETY equipment solution** meets the requirements of the new cargo restraint regulations. Our modules are integrated with structural elements where “Airline” anchoring fittings, such as belts, nets and telescopic bars can easily fit. This new equipment for commercial vehicles simplifies the securing of medium-sized or small parts, even if the floor panel of your van has no anchoring systems, to guarantee maximum load securing. The “Airline” anchoring fittings for SAFETY equipment improve the stability of modules with no weight increase, because they are built in the equipment structure.





FAHRZEUGEINRICHTUNGSBEISPIELE - FITTINGS EXAMPLES

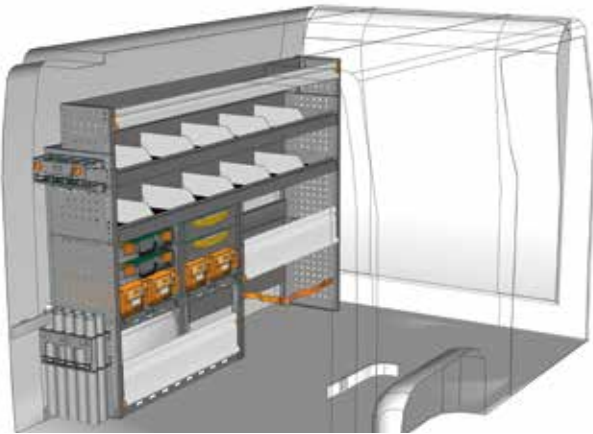

BEISPIEL - EXAMPLE

MA 2014 01*

B=2032 T=365 H=1400 mm - W=2032 D=365 H=1400 mm

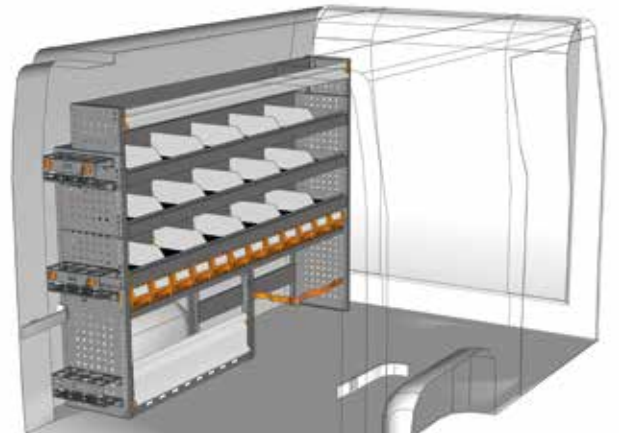

BEISPIEL - EXAMPLE

MA 2014 02*

B=2032 T=365 H=1400 mm - W=2032 D=365 H=1400 mm

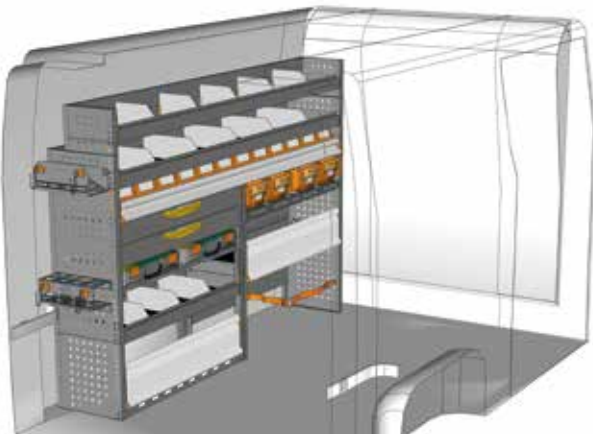
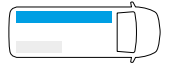

BEISPIEL - EXAMPLE

MA 2014 03*

B=2032 T=365 H=1400 mm - W=2032 D=365 H=1400 mm

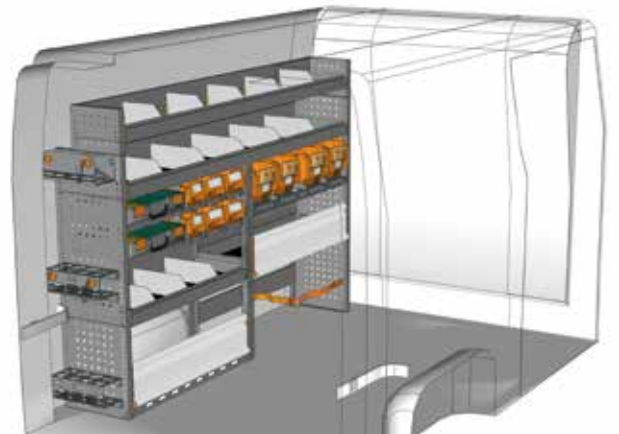
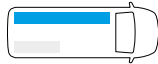

BEISPIEL - EXAMPLE

MA 2014 04*

B=2032 T=365 H=1490 mm - W=2032 D=365 H=1400 mm

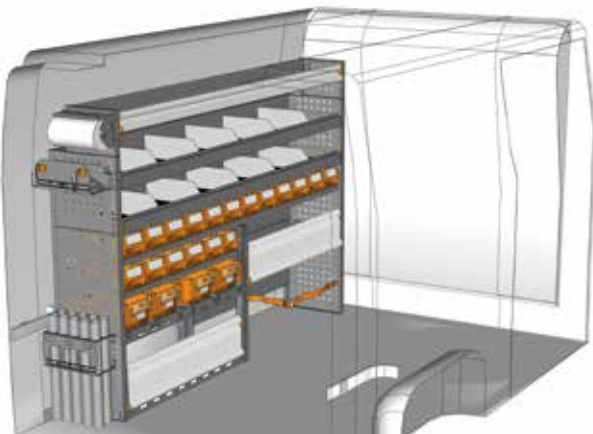
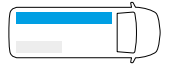

BEISPIEL - EXAMPLE

MA 2014 06*

B=2032 T=365 H=1490 mm - W=2032 D=365 H=1400 mm

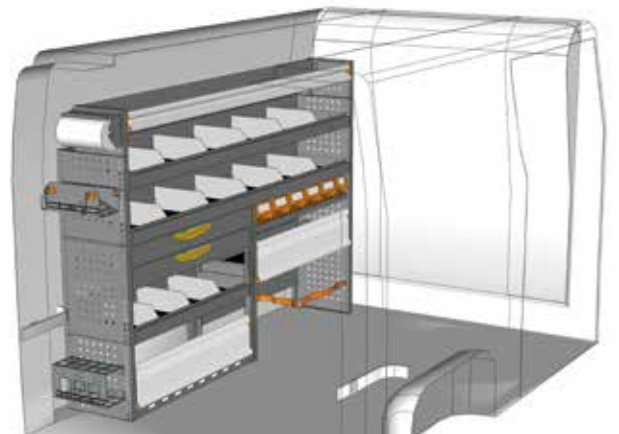
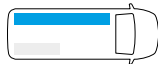

BEISPIEL - EXAMPLE

MA 2014 07*

B=2032 T=365 H=1480 mm - W=2032 D=365 H=1400 mm

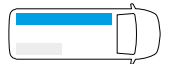

* Einschließlich Befestigungskit - Fixing kit included



FAHRZEUGEINRICHTUNGSBEISPIELE - FITTINGS EXAMPLES

KASTENWAGEN - PANEL VAN
NISSAN NV400

SAFETY

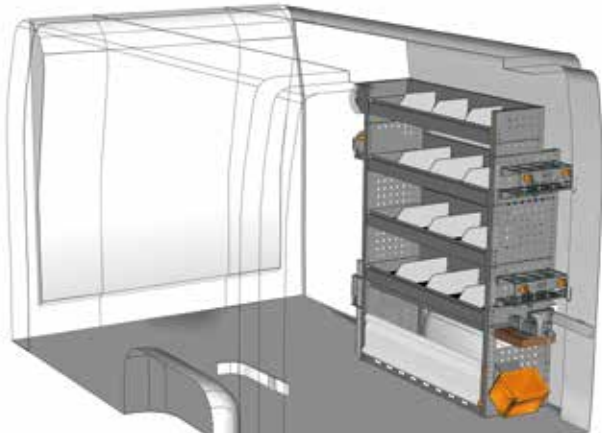

BEISPIEL - EXAMPLE

MA 1014 01*

B=1016 T=365 H=1400 mm - W=1016 D=365 H=1400 mm

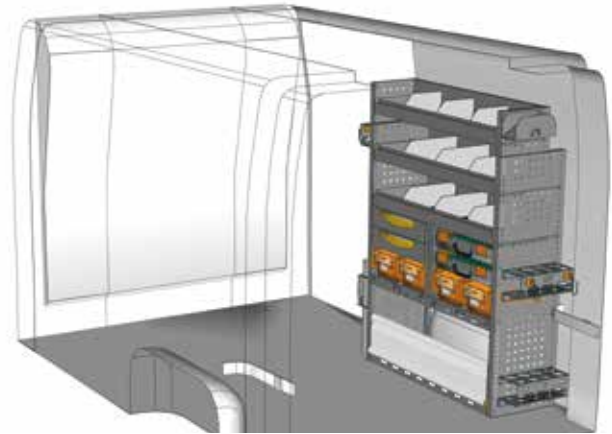
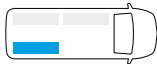

BEISPIEL - EXAMPLE

MA 1014 02*

B=1016 T=365 H=1400 mm - W=1016 D=365 H=1400 mm

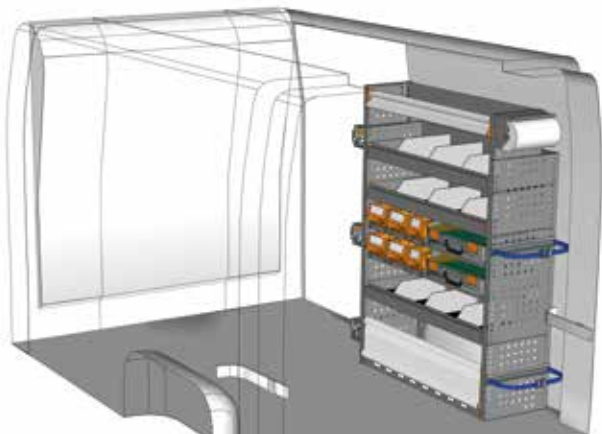
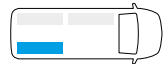

BEISPIEL - EXAMPLE

MA 1014 05*

B=1016 T=365 H=1400 mm - W=1016 D=365 H=1400 mm

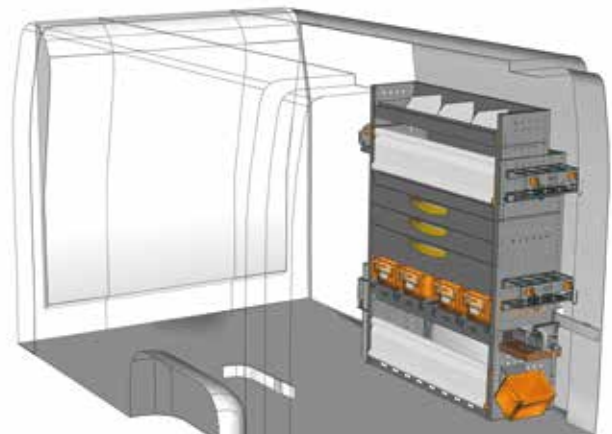
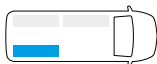

BEISPIEL - EXAMPLE

MA 1014 09*

B=1016 T=365 H=1400 mm - W=1016 D=365 H=1400 mm

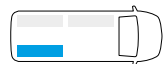

Ansicht von der Schiebetür
View from side door

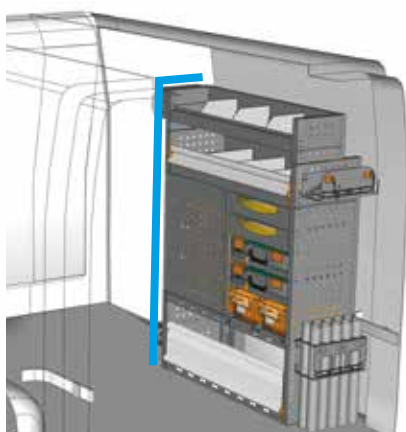

BEISPIEL - EXAMPLE

MA 1014 10*

B=1016 T=365 H=1400 mm - W=1016 D=365 H=1400 mm

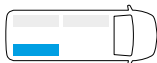

Haben Sie Ihre Einrichtung nicht gefunden?
Verlassen Sie sich auf die Profis für Fahrzeugeinrichtungen.
Auf der Rückseite dieses Katalogs finden Sie die nächstgelegene StoreVan Niederlassung. Besuchen Sie unsere Web-Seite.

Didn't find the equipment you're looking for?
Leave it to our experts.
See the back of this catalogue and contact the nearest StoreVan point or visit our website.



* Einschließlich Befestigungskit - Fixing kit included

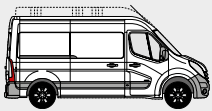

FAHRZEUGEINRICHTUNGSBEISPIELE - FITTINGS EXAMPLES

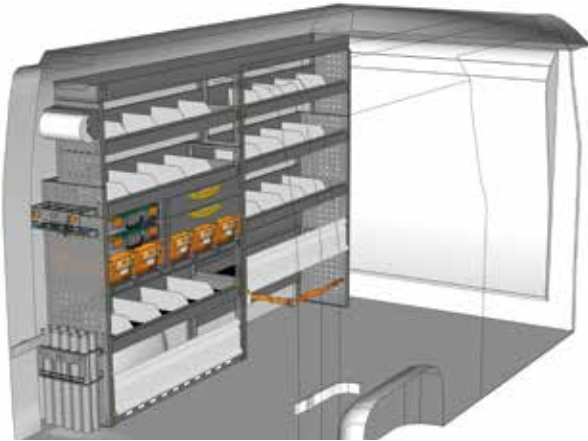

BEISPIEL - EXAMPLE

MA 2417 01*

B=2450 T=365 H=1690 mm - W=2450 D=365 H=1690 mm

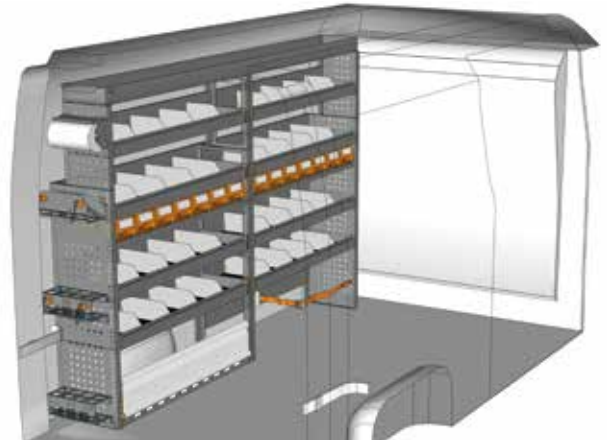
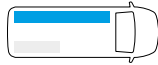

BEISPIEL - EXAMPLE

MA 2417 02*

B=2450 T=365 H=1690 mm - W=2450 D=365 H=1690 mm

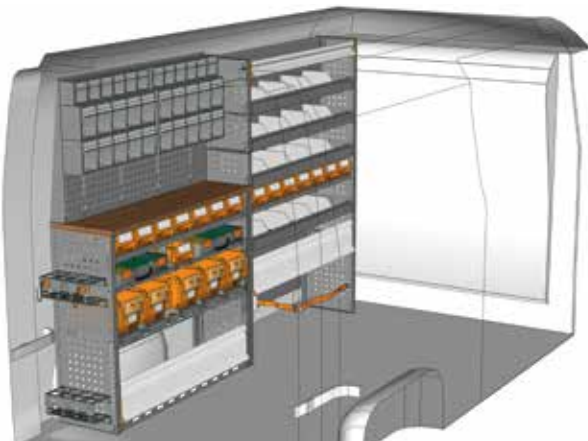
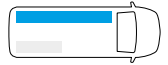

BEISPIEL - EXAMPLE

MA 2417 03*

B=2450 T=365 H=1725 mm - W=2450 D=365 H=1725 mm

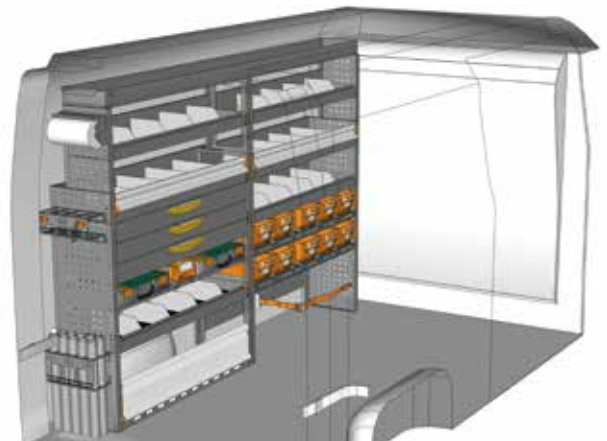
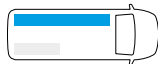

BEISPIEL - EXAMPLE

MA 2417 04*

B=2450 T=365 H=1690 mm - W=2450 D=365 H=1690 mm

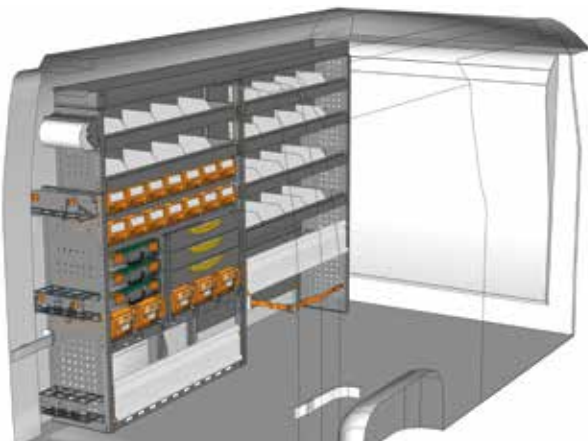
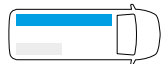

BEISPIEL - EXAMPLE

MA 2417 05*

B=2450 T=365 H=1690 mm - W=2450 D=365 H=1690 mm

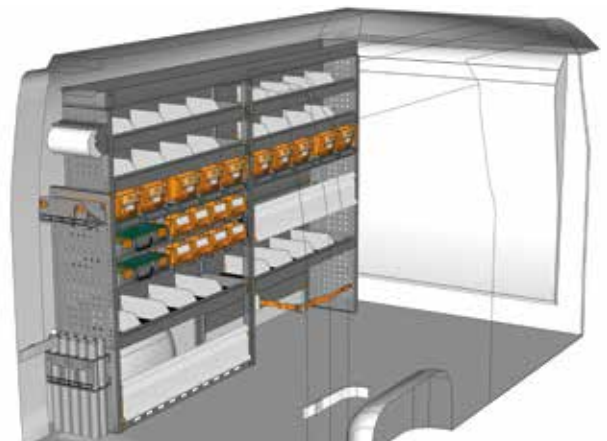
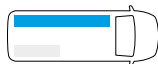

BEISPIEL - EXAMPLE

MA 2417 06*

B=2450 T=365 H=1690 mm - W=2450 D=365 H=1690 mm

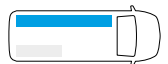

* Einschließlich Befestigungskit - Fixing kit included

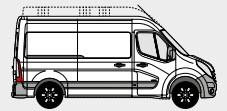

FAHRZEUGEINRICHTUNGSBEISPIELE - FITTINGS EXAMPLES

KASTENWAGEN - PANEL VAN
NISSAN NV400

SAFETY

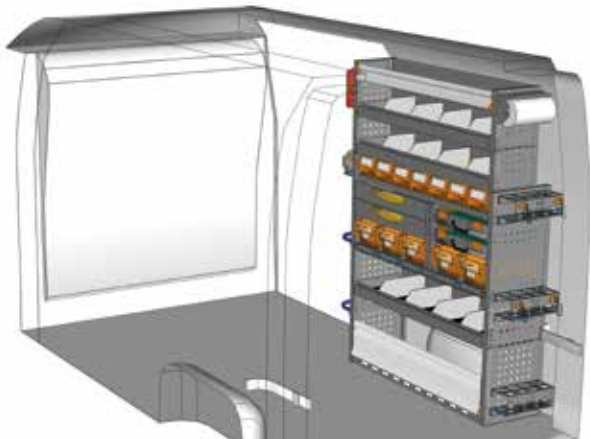

BEISPIEL - EXAMPLE

MA 1217 01*

B=1225 T=365 H=1700 mm - W=1225 D=365 H=1700 mm

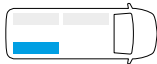

Ansicht von der Schiebetür
View from side door



BEISPIEL - EXAMPLE

MA 1217 02*

B=1225 T=365 H=1700 mm - W=1225 D=365 H=1700 mm

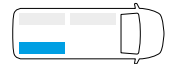

BEISPIEL - EXAMPLE

MA 1217 05*

B=1225 T=365 H=1700 mm - W=1225 D=365 H=1700 mm

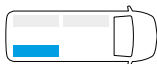

BEISPIEL - EXAMPLE

MA 1217 07*

B=1225 T=365 H=1700 mm - W=1225 D=365 H=1700 mm

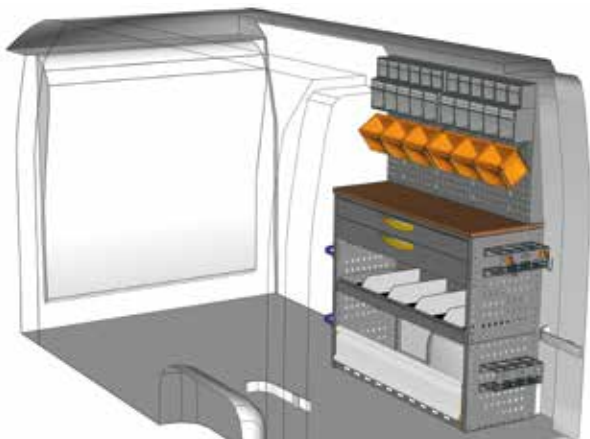
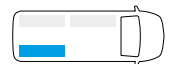

BEISPIEL - EXAMPLE

MA 1217 10*

B=1225 T=445 H=1725 mm - W=1225 D=445 H=1725 mm

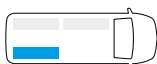

Haben Sie Ihre Einrichtung nicht gefunden?

Verlassen Sie sich auf die Profis für Fahrzeugeinrichtungen.

Auf der Rückseite dieses Katalogs finden Sie die nächstgelegene StoreVan Niederlassung. Besuchen Sie unsere Web-Seite.

Didn't find the equipment you're looking for?

Leave it to our experts.

See the back of this catalogue and contact the nearest StoreVan point or visit our website.



* Einschließlich Befestigungskit - Fixing kit included

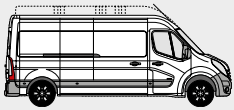

FAHRZEUGEINRICHTUNGSBEISPIELE - FITTINGS EXAMPLES

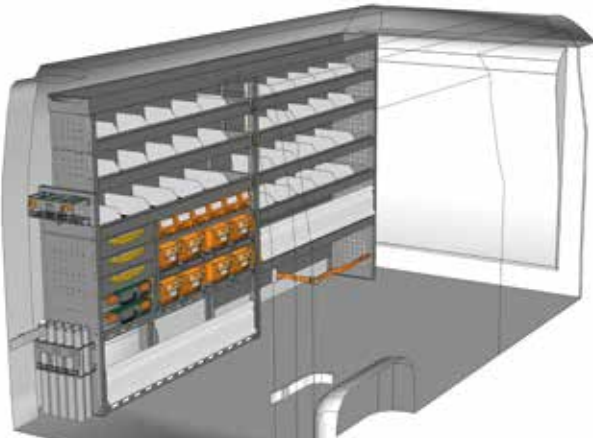

BEISPIEL - EXAMPLE

MA 3017 01*

B=3048 T=365 H=1690 mm - W=3048 D=365 H=1690 mm

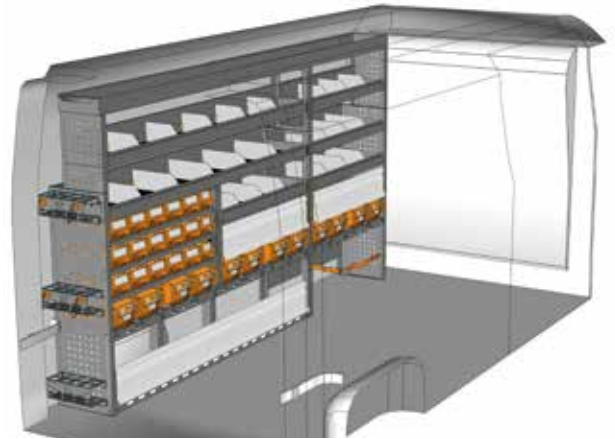
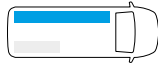

BEISPIEL - EXAMPLE

MA 3017 02*

B=3048 T=365 H=1690 mm - W=3048 D=365 H=1690 mm

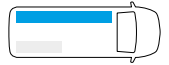

BEISPIEL - EXAMPLE

MA 3017 03*

B=3048 T=365 H=1690 mm - W=3048 D=365 H=1690 mm

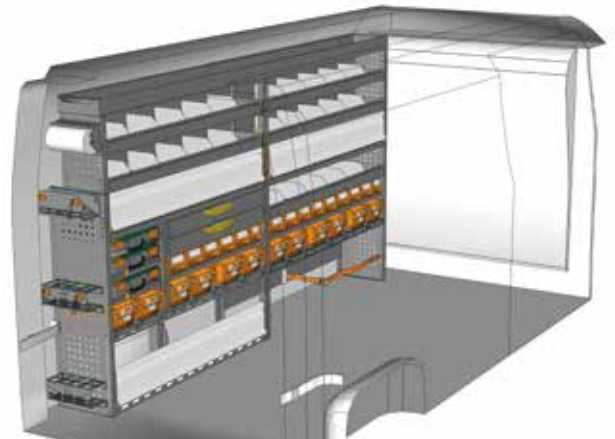
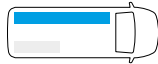

BEISPIEL - EXAMPLE

MA 3017 04*

B=3048 T=365 H=1690 mm - W=3048 D=365 H=1690 mm

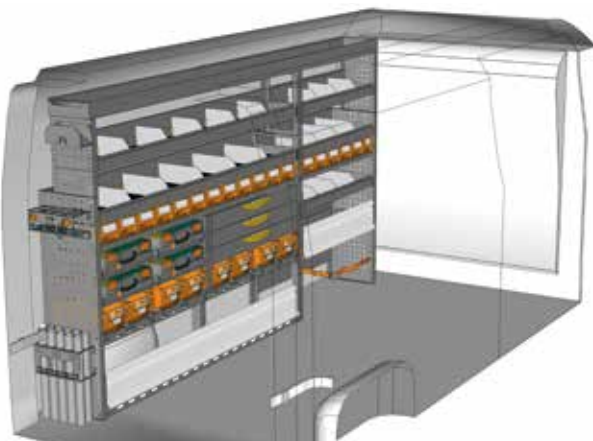
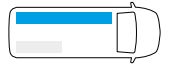

BEISPIEL - EXAMPLE

MA 3017 05*

B=3048 T=365 H=1690 mm - W=3048 D=365 H=1690 mm

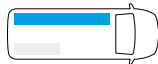

BEISPIEL - EXAMPLE

MA 3017 07*

B=3048 T=365 H=1690 mm - W=3048 D=365 H=1690 mm

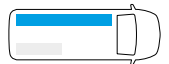

* Einschließlich Befestigungskit - Fixing kit included

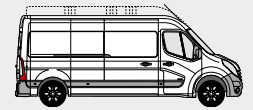

FAHRZEUGEINRICHTUNGSBEISPIELE - FITTINGS EXAMPLES

KASTENWAGEN - PANEL VAN
NISSAN NV400

SAFETY

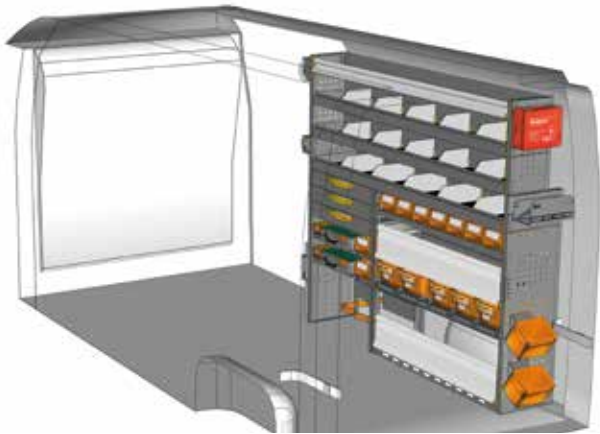

BEISPIEL - EXAMPLE

MA 1917 02*

B=1942 T=365 H=1700 mm - W=1942 D=365 H=1700 mm

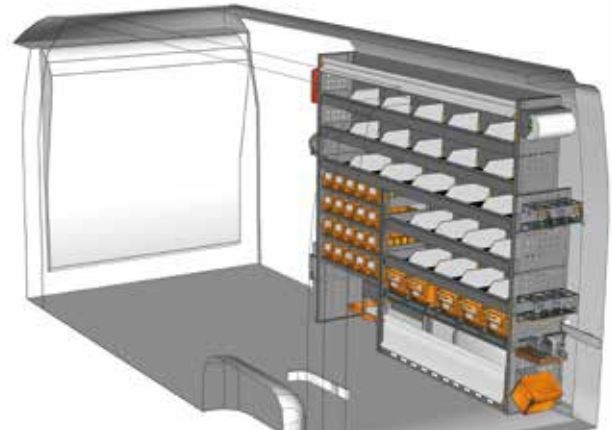
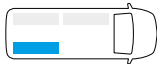

BEISPIEL - EXAMPLE

MA 1917 03*

B=1942 T=365 H=1700 mm - W=1942 D=365 H=1700 mm

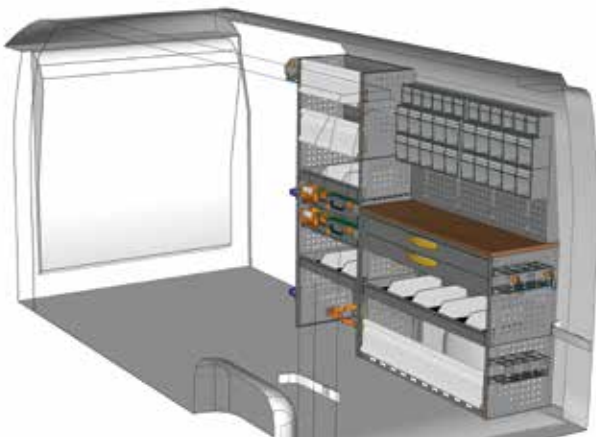
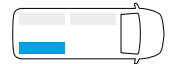

BEISPIEL - EXAMPLE

MA 1917 07*

B=1942 T=445 H=1700 mm - W=1942 D=445 H=1700 mm

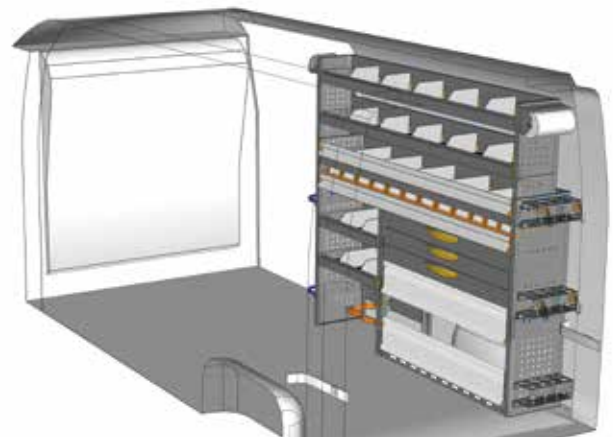
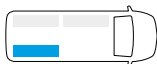

BEISPIEL - EXAMPLE

MA 1917 08*

B=1942 T=365 H=1700 mm - W=1942 D=365 H=1700 mm

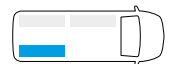

Ansicht von der Schiebetür
View from side door

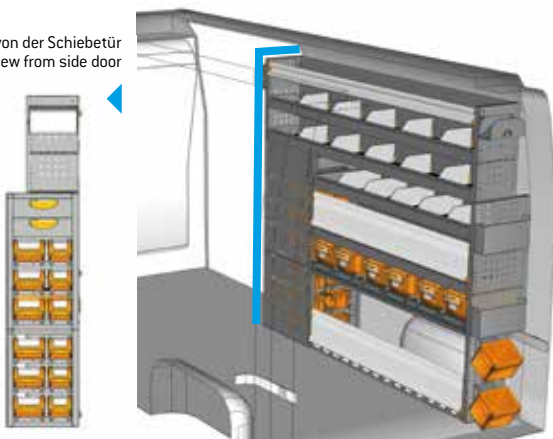

BEISPIEL - EXAMPLE

MA 2017 01*

B=2032 T=365 H=1700 mm - W=2032 D=365 H=1700 mm

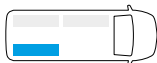

Haben Sie Ihre Einrichtung nicht gefunden?
Verlassen Sie sich auf die Profis für Fahrzeugeinrichtungen.
Auf der Rückseite dieses Katalogs finden Sie die nächstgelegene StoreVan Niederlassung. Besuchen Sie unsere Web-Seite.

Didn't find the equipment you're looking for? Leave it to our experts.
See the back of this catalogue and contact the nearest StoreVan point or visit our website.



* Einschließlich Befestigungskit - Fixing kit included

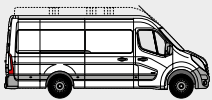

FAHRZEUGEINRICHTUNGSBEISPIELE - FITTINGS EXAMPLES

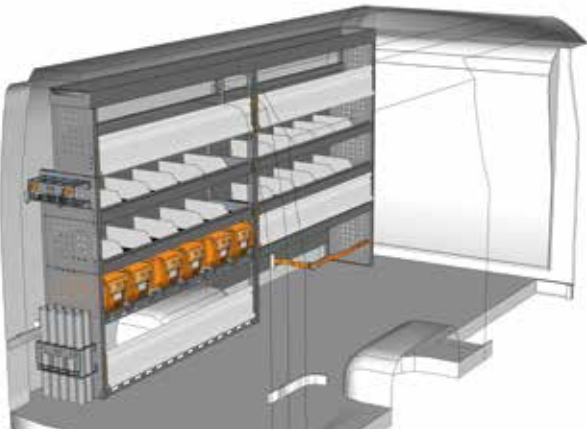

BEISPIEL - EXAMPLE

MA 3016 01*

B=3048 T=365 H=1640 mm - W=3048 D=365 H=1640 mm

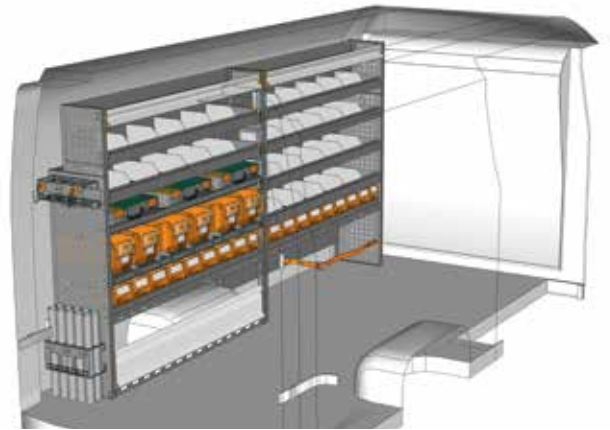
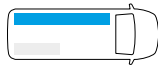

BEISPIEL - EXAMPLE

MA 3016 02*

B=3048 T=365 H=1550 mm - W=3048 D=365 H=1550 mm

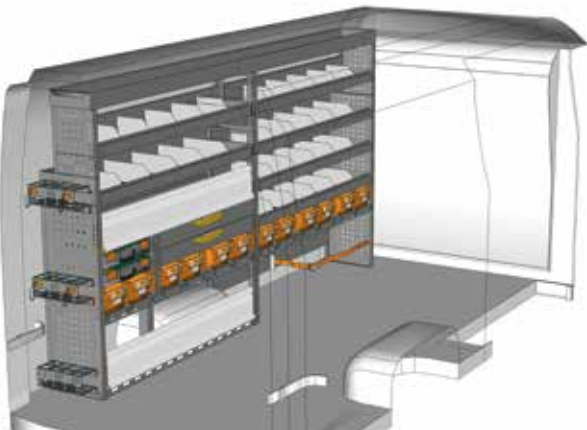
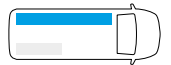

BEISPIEL - EXAMPLE

MA 3016 03*

B=3048 T=365 H=1640 mm - W=3048 D=365 H=1640 mm

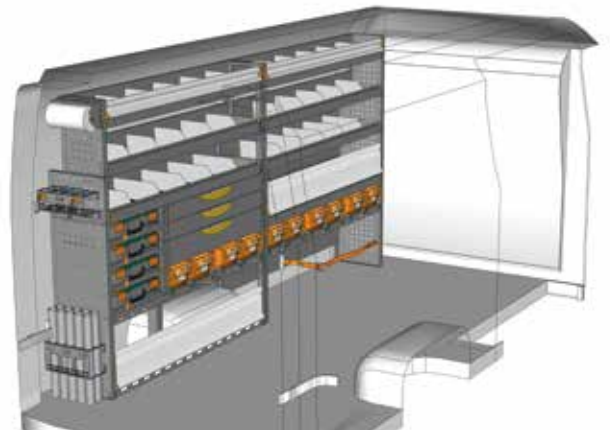
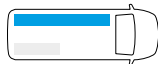

BEISPIEL - EXAMPLE

MA 3016 04*

B=3048 T=365 H=1600 mm - W=3048 D=365 H=1600 mm

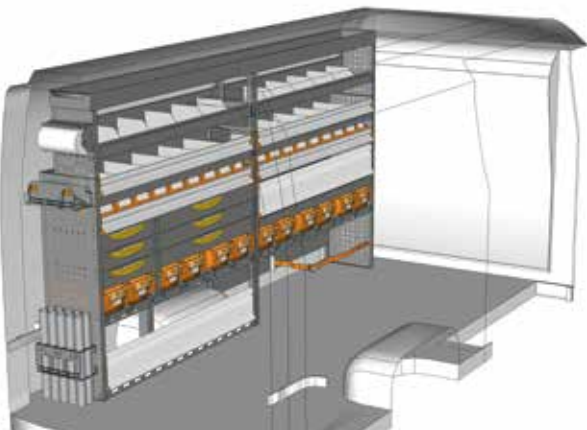

BEISPIEL - EXAMPLE

MA 3016 05*

B=3048 T=365 H=1640 mm - W=3048 D=365 H=1640 mm

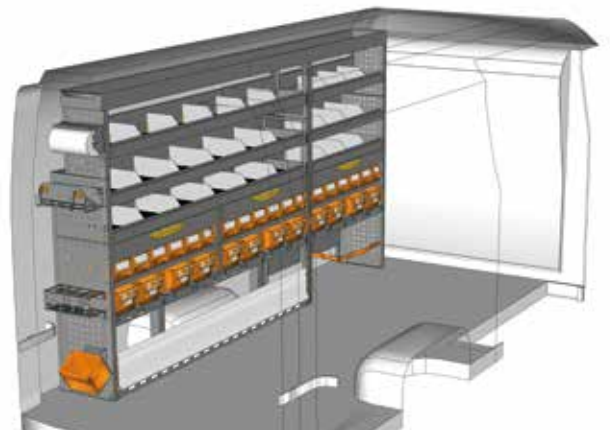
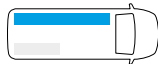

BEISPIEL - EXAMPLE

MA 3016 06*

B=3048 T=365 H=1640 mm - W=3048 D=365 H=1640 mm

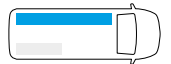

* Einschließlich Befestigungskit - Fixing kit included

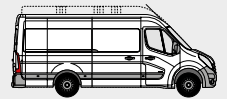

FAHRZEUGEINRICHTUNGSBEISPIELE - FITTINGS EXAMPLES

KASTENWAGEN - PANEL VAN
NISSAN NV400

SAFETY

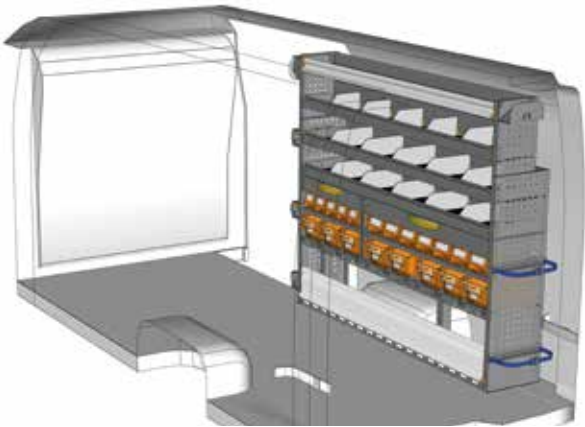

BEISPIEL - EXAMPLE

MA 1916 01*

B=1942 T=365 H=1600 mm - W=1942 D=365 H=1600 mm

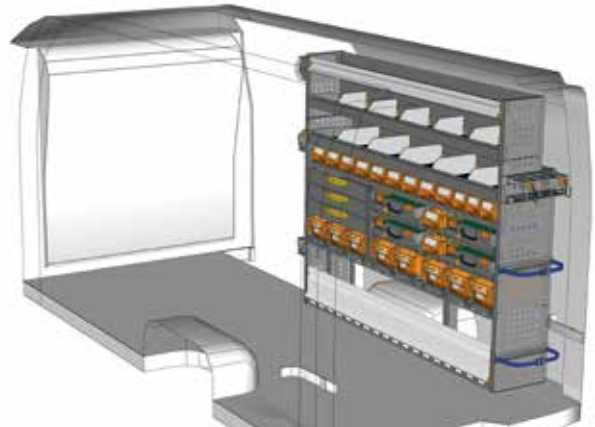
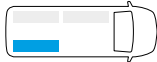

BEISPIEL - EXAMPLE

MA 1916 02*

B=1942 T=365 H=1600 mm - W=1942 D=365 H=1600 mm

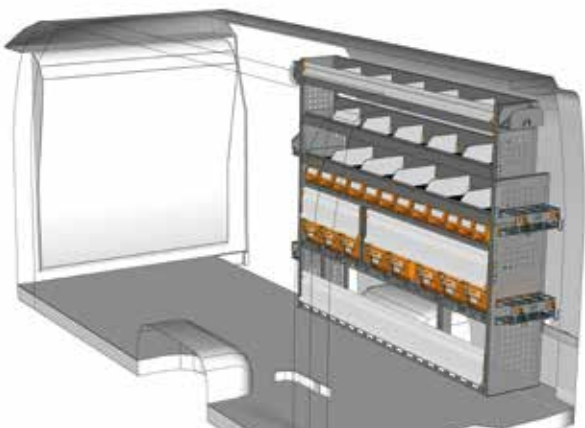
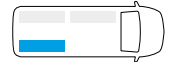

BEISPIEL - EXAMPLE

MA 1916 03*

B=1942 T=365 H=1600 mm - W=1942 D=365 H=1600 mm

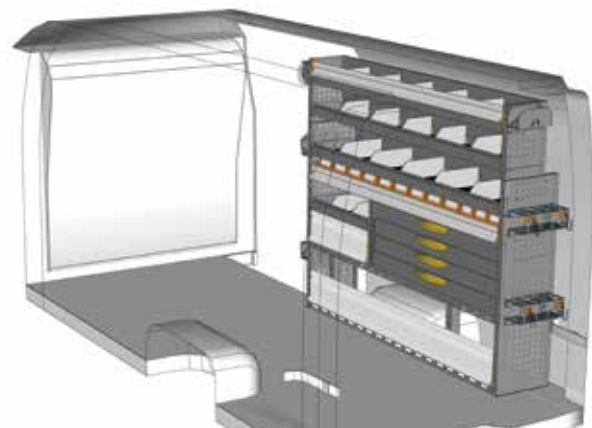

BEISPIEL - EXAMPLE

MA 1916 04*

B=1942 T=365 H=1600 mm - W=1942 D=365 H=1600 mm



Ansicht von der Schiebetür
View from side door

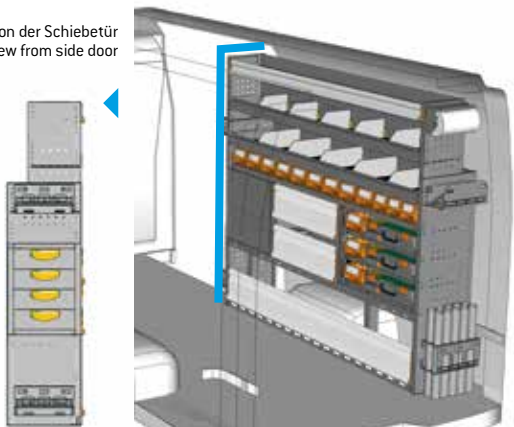

BEISPIEL - EXAMPLE

MA 1916 05*

B=1942 T=445 H=1600 mm - W=1942 D=445 H=1600 mm



Haben Sie Ihre Einrichtung nicht gefunden?
Verlassen Sie sich auf die Profis für Fahrzeugeinrichtungen.
Auf der Rückseite dieses Katalogs finden Sie die nächstgelegene StoreVan Niederlassung. Besuchen Sie unsere Web-Seite.

Didn't find the equipment you're looking for?
Leave it to our experts.
See the back of this catalogue and contact the nearest StoreVan point or visit our website.



* Einschließlich Befestigungskit - Fixing kit included



NISSAN NV400
KASTENWAGEN - PANEL VAN

PROFESSIONAL



**Die perfekte
Integration zwischen
Fahrzeug und mobiler
Werkstatteinrichtung**

**Perfect integration
between vehicle and
mobile workshop
equipment**



Die Transportereinrichtung **PROFESSIONAL** von Store Van ist perfekt im Fahrzeug integriert und eigens so entwickelt, dass sie die strukturellen und dynamischen Eigenschaften des Fahrzeugs hervorhebt. In den Modulen dieses neuen **Einrichtungsniveaus für Nutzfahrzeug**, z.B. in den Regalen für Transporter, sind für eine perfekte Befestigung der Ladung am Fahrzeugrahmen serienmäßig Elemente eingebaut, die „Airline“ Festhaltesysteme nutzen. Dank der neuen Bodenplatte **SAFETY FLOOR** stehen für die Ladungen vertikale und horizontale Festhaltesysteme zur Verfügung.

The Store Van **PROFESSIONAL equipment solution** is perfectly integrated in your vehicle and has been designed to enhance its structural and dynamic characteristics. The modules of this new **equipment for commercial vehicles**, such as shelving units for vans, are factory fitted with elements ensuring a perfect load anchoring to the chassis of your vehicle with „Airline“ anchoring systems.

Both vertical and horizontal load restraining elements can be installed in your van thanks to the new **SAFETY FLOOR** panel.





FAHRZEUGEINRICHTUNGSBEISPIELE - FITTINGS EXAMPLES

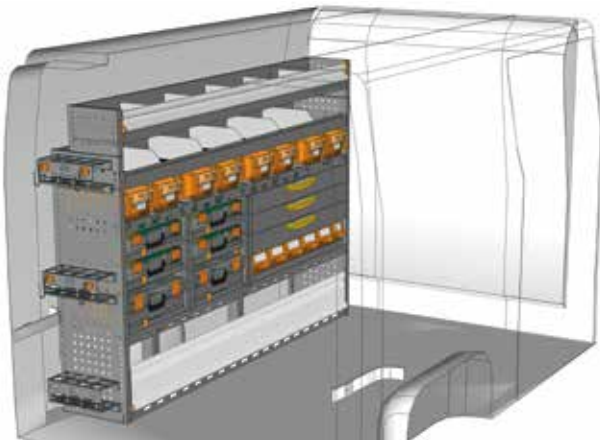

BEISPIEL - EXAMPLE

MA 2014 P1*

B=2032 T=365 H=1400 mm - W=2032 D=365 H=1400 mm

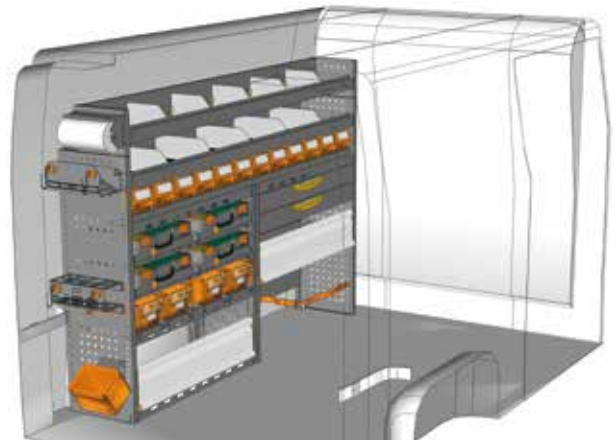
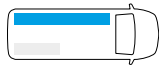

BEISPIEL - EXAMPLE

MA 2014 P2*

B=2032 T=365 H=1400 mm - W=2032 D=365 H=1400 mm

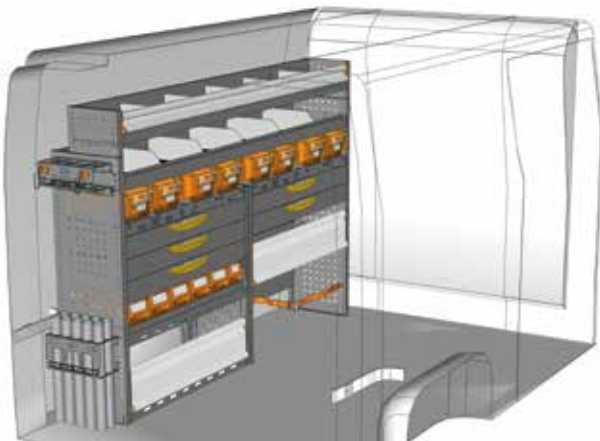
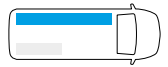

BEISPIEL - EXAMPLE

MA 2014 P3*

B=2032 T=365 H=1400 mm - W=2032 D=365 H=1400 mm

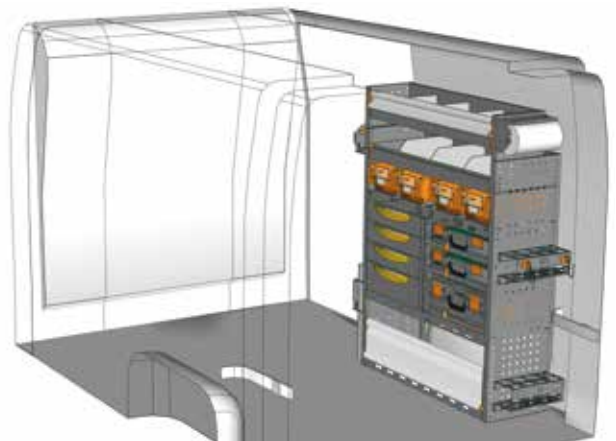
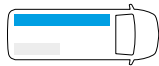

BEISPIEL - EXAMPLE

MA 1014 P1*

B=1016 T=365 H=1400 mm - W=1016 D=365 H=1400 mm

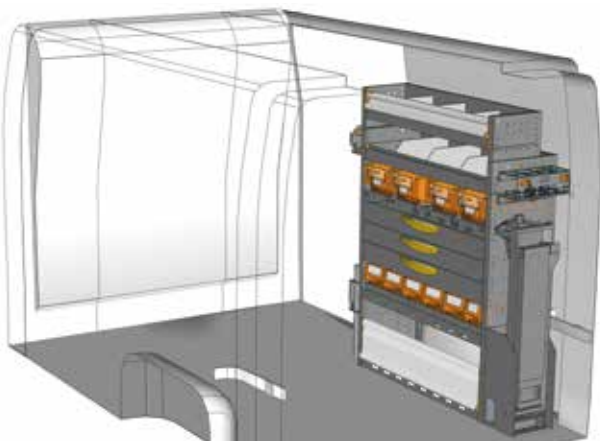
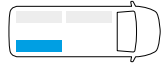

BEISPIEL - EXAMPLE

MA 1014 P2*

B=1016 T=365 H=1400 mm - W=1016 D=365 H=1400 mm

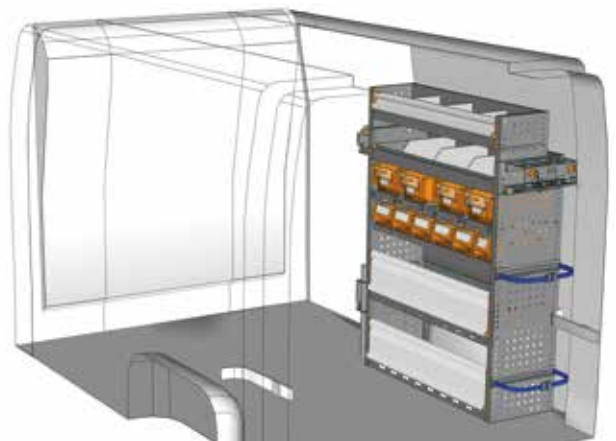
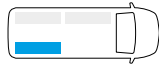

BEISPIEL - EXAMPLE

MA 1014 P3*

B=1016 T=365 H=1400 mm - W=1016 D=365 H=1400 mm

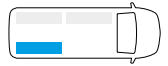

* Einschließlich Befestigungskit - Fixing kit included



FAHRZEUGEINRICHTUNGSBEISPIELE - FITTINGS EXAMPLES

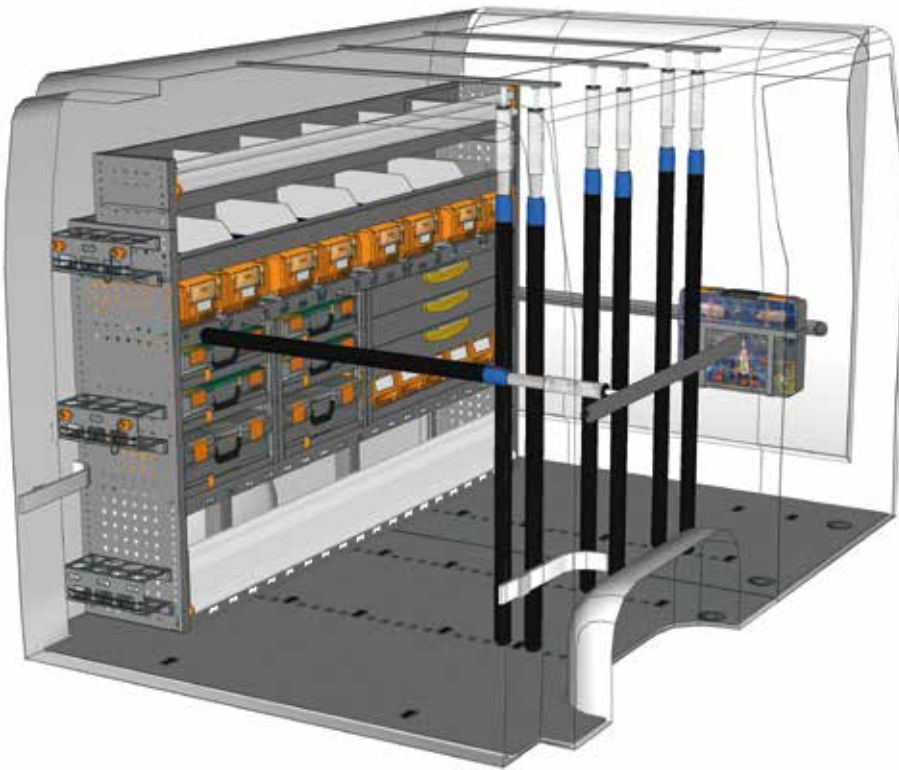

BEISPIEL - EXAMPLE

EXAMPLE MA L1H1 P1*



1 x MA 2014 P1	3 x V18025 15
1 x MA 10G1 A0	1 x B0X080
1 x V22585	1 x CPV080
1 x V22131	2 x V22136
6 x V22017	2 x V22124
1 x V18029 15	2 x V22148
1 x V18029 10	1 x YELLOW
4 x V22106	4 x V225820

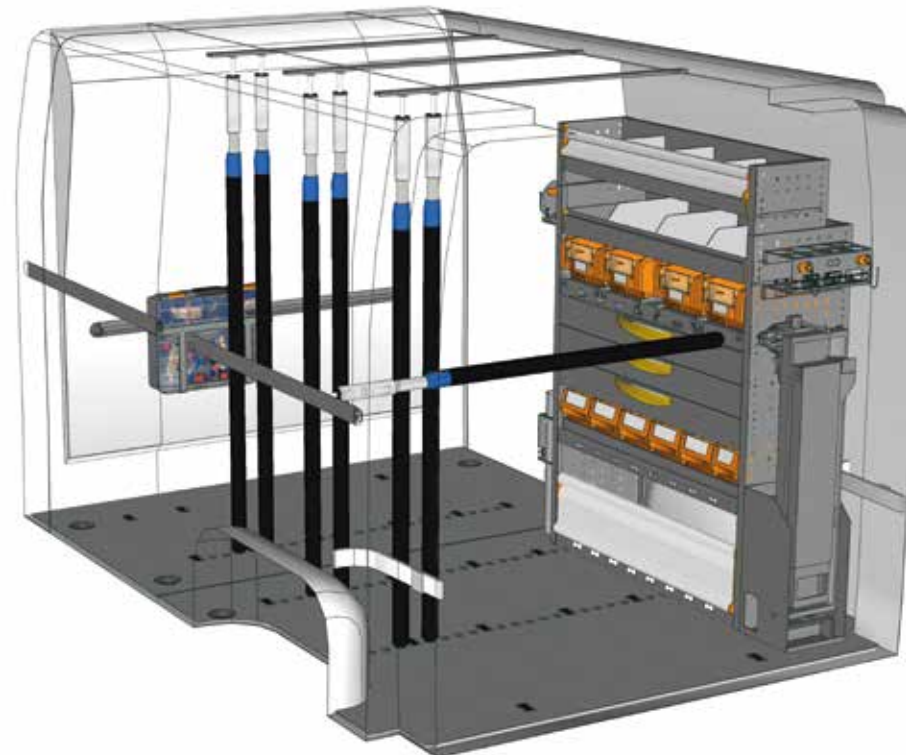

BEISPIEL - EXAMPLE

EXAMPLE MA L1H1 P2*



1 x MA 1014 P2	3 x V18025 15
1 x MA 10G1 A0	1 x B0X080
1 x V22585	1 x CPV080
1 x V22131	2 x V22136
6 x V22017	2 x V22124
2 x V18029 10	2 x V22148
1 x V18029 15	1 x YELLOW
6 x V22106	4 x V225820

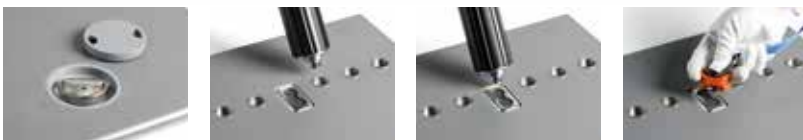

siehe Seiten 10/11
see pages 10/11

* Einschließlich Befestigungskit - Fixing kit included

**Haben Sie Ihre Einrichtung nicht gefunden?
Verlassen Sie sich auf die Profis für
Fahrzeugeinrichtungen.**

Auf der Rückseite dieses Katalogs
finden Sie die nächstgelegene
StoreVan Niederlassung.
Besuchen Sie unsere Web-Seite.

**Didn't find the equipment
you're looking for?
Leave it to our experts.**

See the back of this catalogue
and contact the nearest
StoreVan point or visit our website.



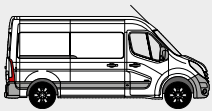

FAHRZEUGEINRICHTUNGSBEISPIELE - FITTINGS EXAMPLES

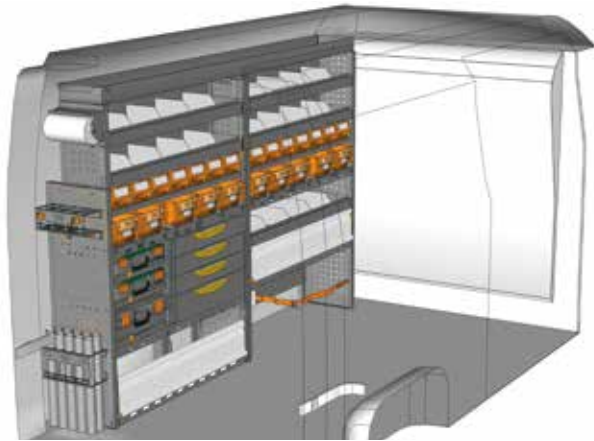

BEISPIEL - EXAMPLE

MA 2417 P1*

B=2450 T=365 H=1690 mm - W=2450 D=365 H=1690 mm

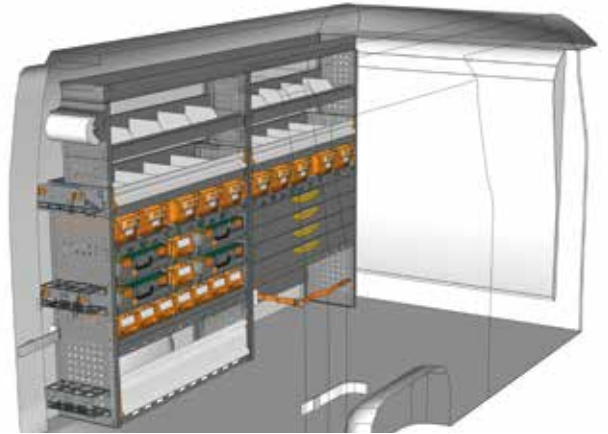
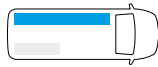

BEISPIEL - EXAMPLE

MA 2417 P2*

B=2450 T=365 H=1690 mm - W=2450 D=365 H=1690 mm

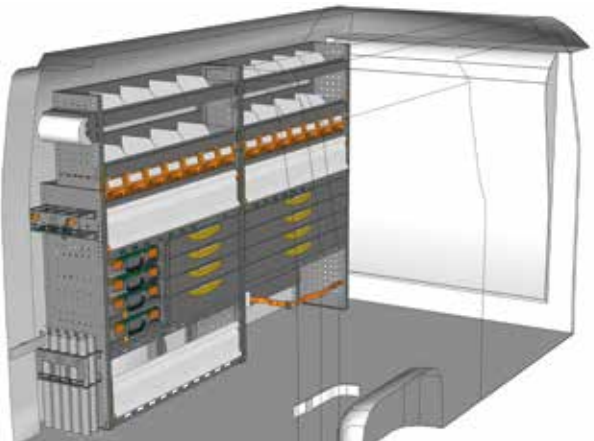

BEISPIEL - EXAMPLE

MA 2417 P3*

B=2450 T=365 H=1650 mm - W=2450 D=365 H=1650 mm

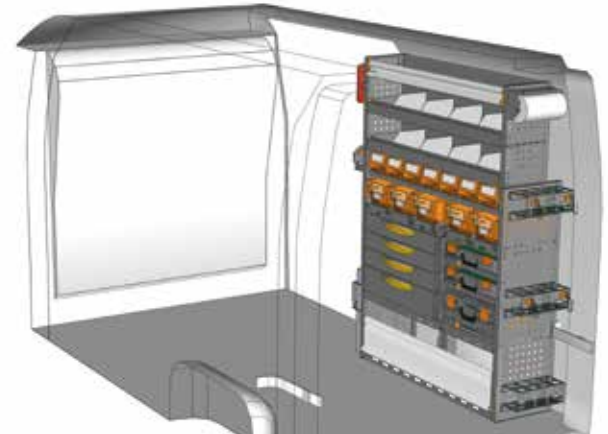
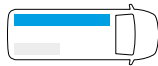

BEISPIEL - EXAMPLE

MA 1217 P1*

B=1225 T=365 H=1700 mm - W=1225 D=365 H=1700 mm

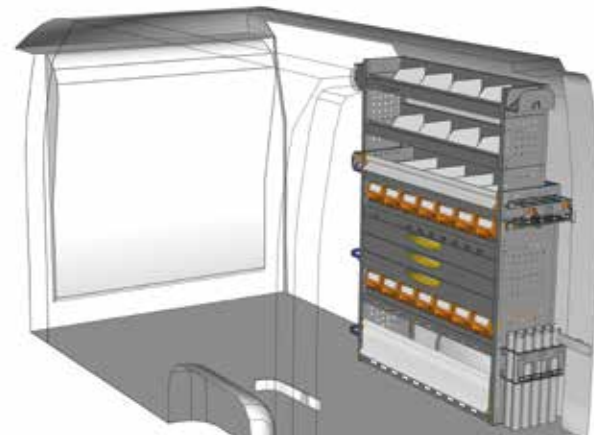
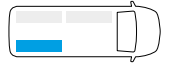

BEISPIEL - EXAMPLE

MA 1217 P2*

B=1225 T=365 H=1700 mm - W=1225 D=365 H=1700 mm

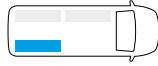

BEISPIEL - EXAMPLE

MA 1217 P3*

B=1225 T=365 H=1700 mm - W=1225 D=365 H=1700 mm

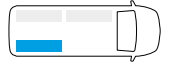

* Einschließlich Befestigungskit - Fixing kit included

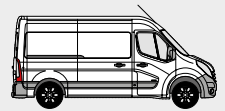

FAHRZEUGEINRICHTUNGSBEISPIELE - FITTINGS EXAMPLES

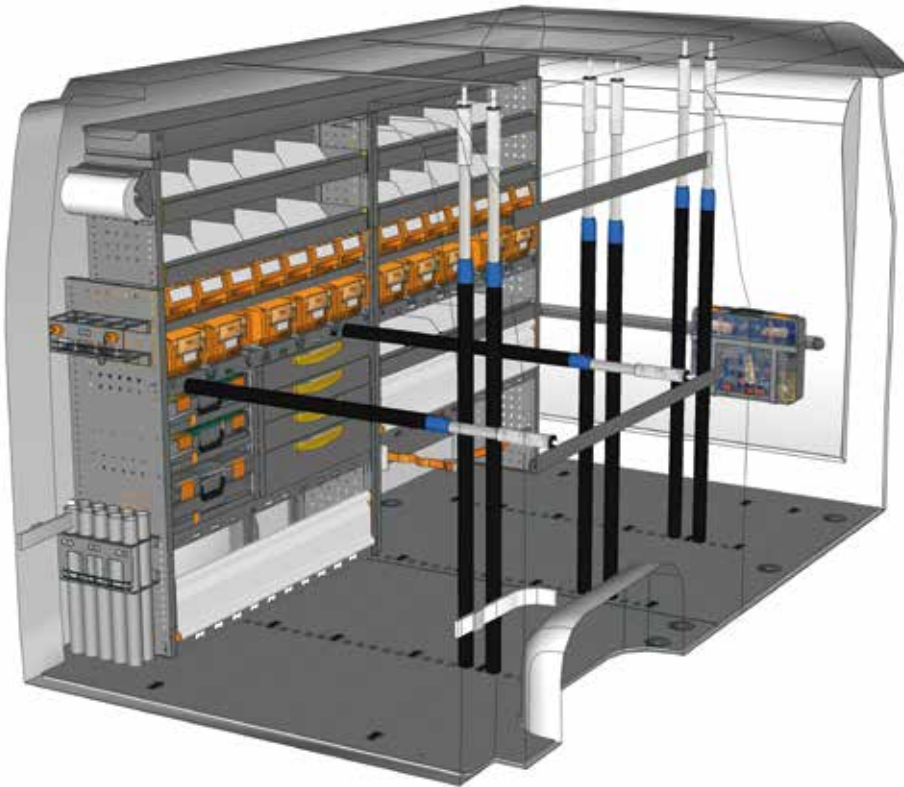

BEISPIEL - EXAMPLE

EXAMPLE MA L2H2 P1*



- | | |
|----------------|-------------|
| 1 x MA 2417 P1 | 1 x BOX080 |
| 1 x MA 20G1 A0 | 1 x CPV080 |
| 1 x V22585 | 2 x V22136 |
| 2 x V22131 | 2 x V22124 |
| 6 x V22017 | 2 x V22148 |
| 3 x V18029 15 | 1 x YELLOW |
| 6 x V22106 | 4 x V225820 |
| 3 x V18025 15 | |

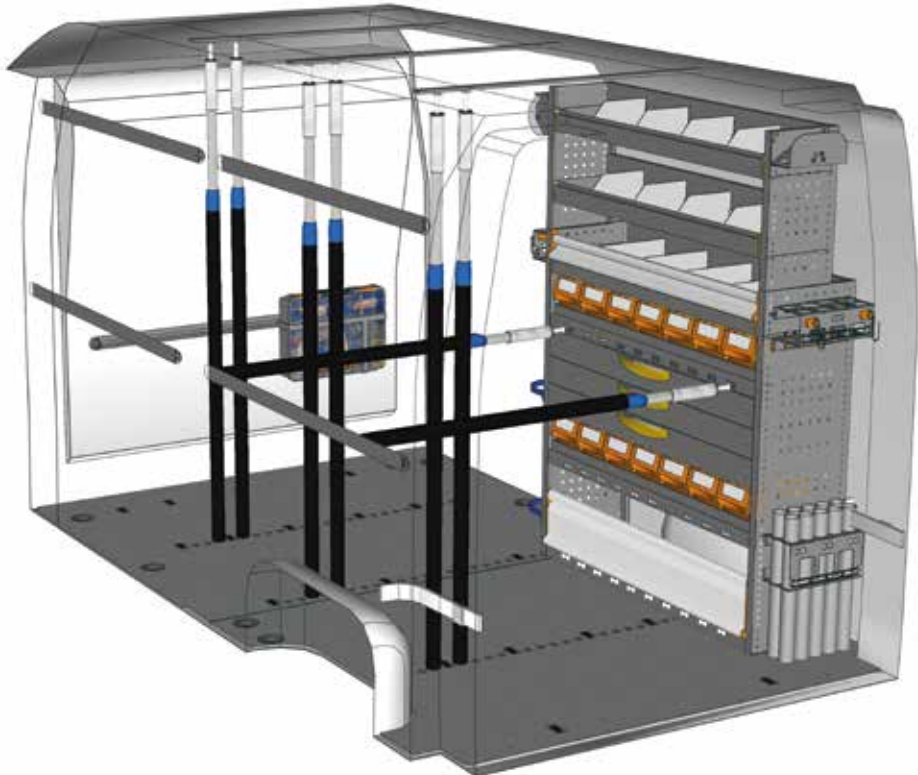

BEISPIEL - EXAMPLE

EXAMPLE MA L2H2 P2*



- | | |
|----------------|-------------|
| 1 x MA 1217 P2 | 1 x BOX080 |
| 1 x MA 20G1 A0 | 1 x CPV080 |
| 1 x V22585 | 2 x V22136 |
| 2 x V22131 | 2 x V22124 |
| 6 x V22017 | 2 x V22148 |
| 5 x V18029 15 | 1 x YELLOW |
| 10 x V22106 | 4 x V225820 |
| 3 x V18025 15 | |

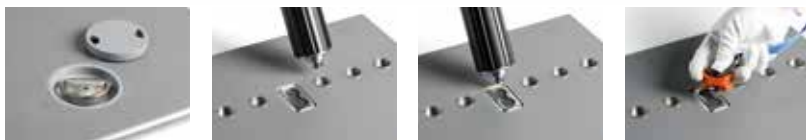

siehe Seiten 10/11
see pages 10/11

* Einschließlich Befestigungskit - Fixing kit included

**Haben Sie Ihre Einrichtung nicht gefunden?
Verlassen Sie sich auf die Profis für
Fahrzeugeinrichtungen.**

Auf der Rückseite dieses Katalogs
finden Sie die nächstgelegene
StoreVan Niederlassung.
Besuchen Sie unsere Web-Seite.

**Didn't find the equipment
you're looking for?
Leave it to our experts.**

See the back of this catalogue
and contact the nearest
StoreVan point or visit our website.



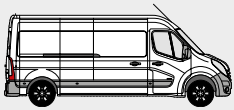

FAHRZEUGEINRICHTUNGSBEISPIELE - FITTINGS EXAMPLES

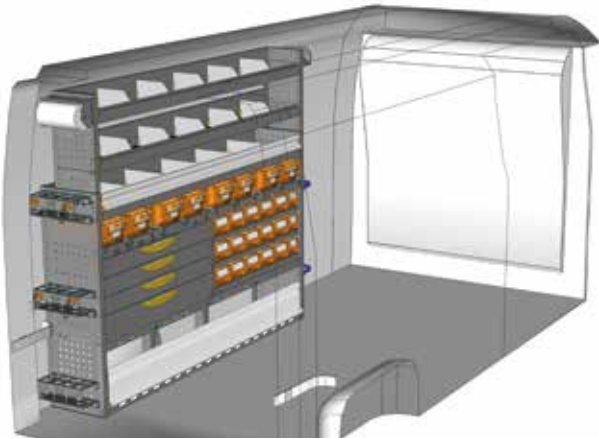

BEISPIEL - EXAMPLE

MA 2017 P1*

B=2032 T=365 H=1700 mm - W=2032 D=365 H=1700 mm

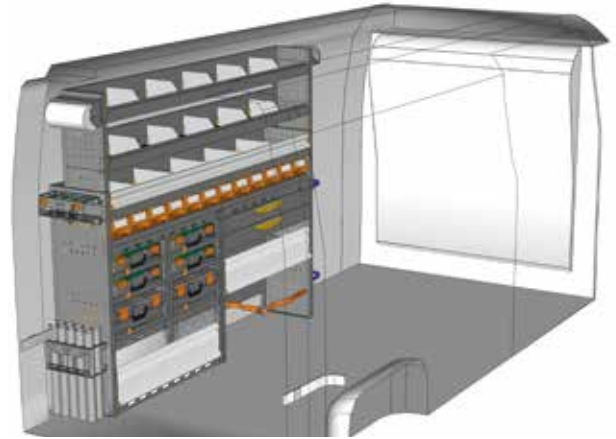
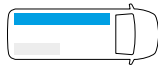

BEISPIEL - EXAMPLE

MA 2017 P2*

B=2032 T=365 H=1700 mm - W=2032 D=365 H=1700 mm

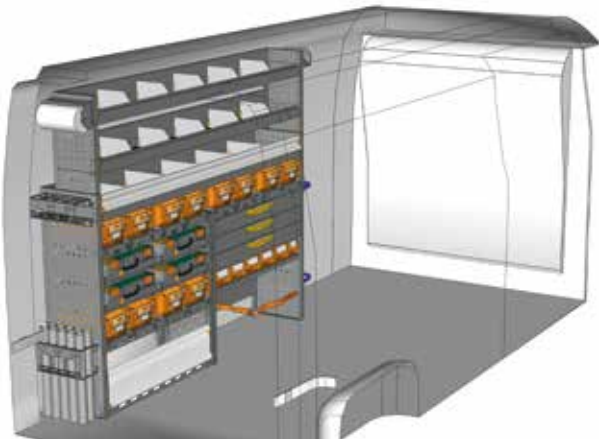
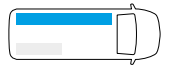

BEISPIEL - EXAMPLE

MA 2017 P3*

B=2032 T=365 H=1700 mm - W=2032 D=365 H=1700 mm

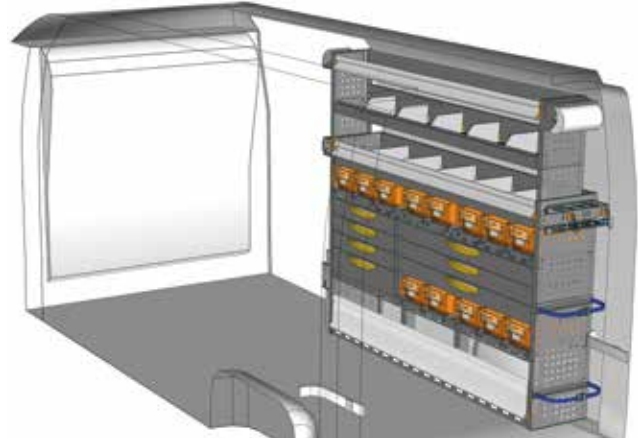
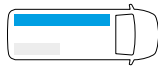

BEISPIEL - EXAMPLE

MA 1917 P1*

B=1942 T=365 H=1700 mm - W=1942 D=365 H=1700 mm

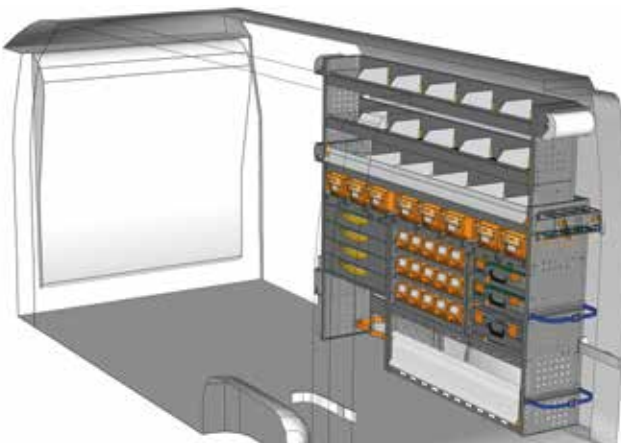
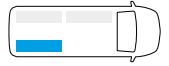

BEISPIEL - EXAMPLE

MA 1917 P2*

B=1942 T=365 H=1700 mm - W=1942 D=365 H=1700 mm

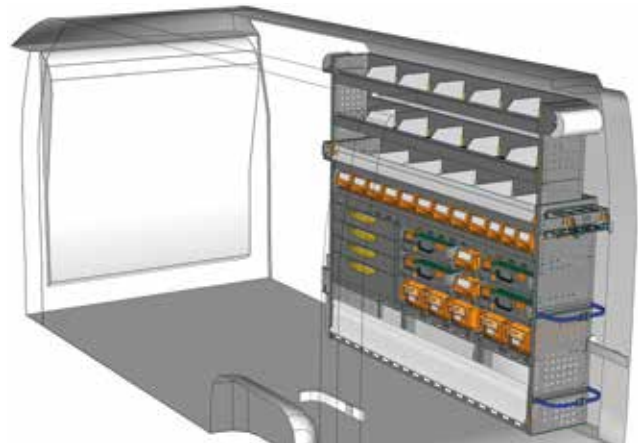
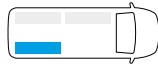

BEISPIEL - EXAMPLE

MA 1917 P3*

B=1942 T=365 H=1700 mm - W=1942 D=365 H=1700 mm

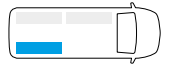

* Einschließlich Befestigungskit - Fixing kit included

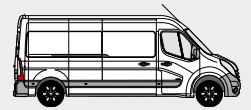

FAHRZEUGEINRICHTUNGSBEISPIELE - FITTINGS EXAMPLES

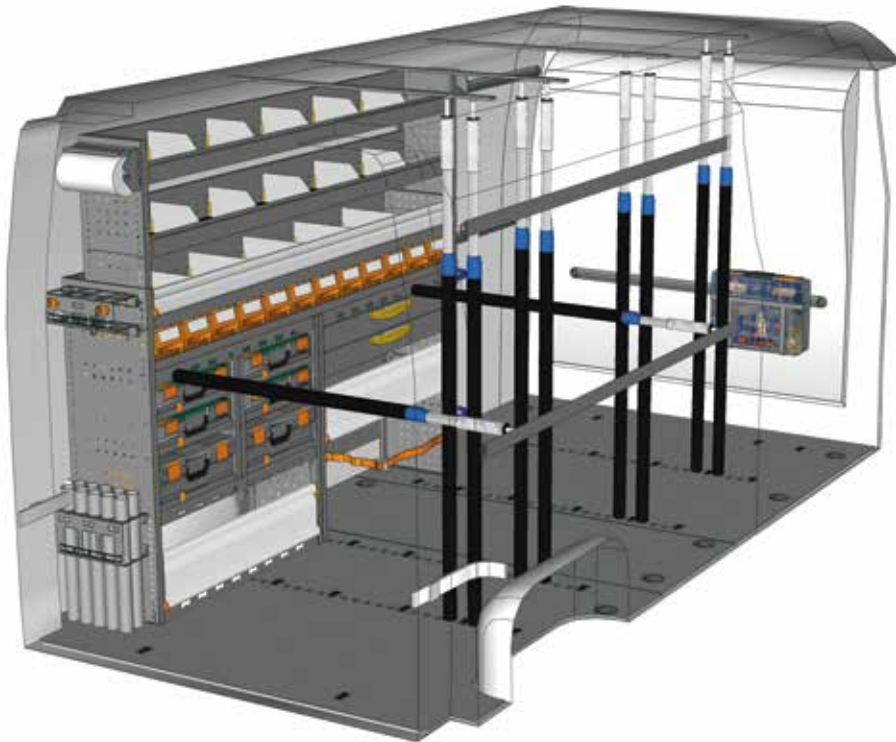

BEISPIEL - EXAMPLE

EXAMPLE MA L3H2 P1*



1 x MA 2017 P2	4 x V18025 15
1 x MA 30G1 A0	1 x B0X080
1 x V22585	1 x CPV080
2 x V22131	2 x V22136
8 x V22017	2 x V22124
3 x V18029 15	2 x V22148
2 x V18029 20	1 x YELLOW
10 x V22106	4 x V225820

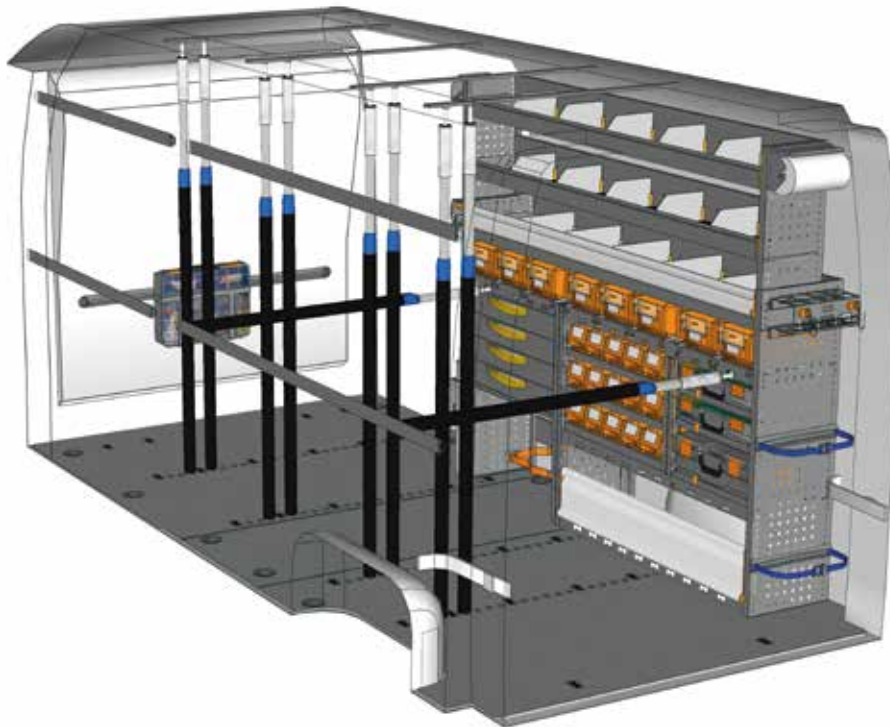

BEISPIEL - EXAMPLE

EXAMPLE MA L3H2 P2*



1 x MA 1917 P2	4 x V18025 15
1 x MA 30G1 A0	1 x B0X080
1 x V22585	1 x CPV080
2 x V22131	2 x V22136
8 x V22017	2 x V22124
3 x V18029 15	2 x V22148
2 x V18029 20	1 x YELLOW
10 x V22106	4 x V225820

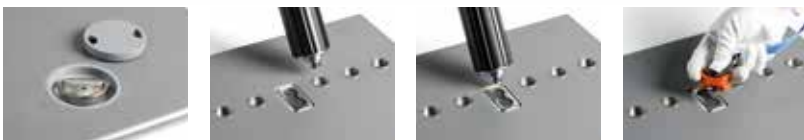

siehe Seiten 10/11
see pages 10/11

* Einschließlich Befestigungskit - Fixing kit included

KASTENWAGEN - PANEL VAN
NISSAN NV400

PROFESSIONAL

**Haben Sie Ihre Einrichtung nicht gefunden?
Verlassen Sie sich auf die Profis für
Fahrzeugeinrichtungen.**

Auf der Rückseite dieses Katalogs
finden Sie die nächstgelegene
StoreVan Niederlassung.
Besuchen Sie unsere Web-Seite.

**Didn't find the equipment
you're looking for?
Leave it to our experts.**

See the back of this catalogue
and contact the nearest
StoreVan point or visit our website.



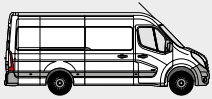

FAHRZEUGEINRICHTUNGSBEISPIELE - FITTINGS EXAMPLES

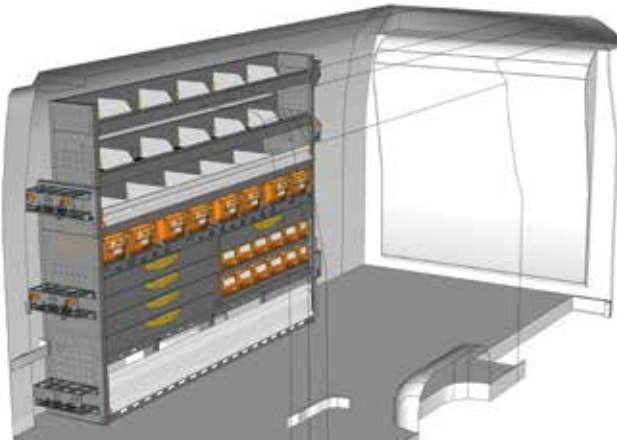

BEISPIEL - EXAMPLE

MA 2016 P1*

B=2032 T=365 H=1600 mm - W=2032 D=365 H=1600 mm

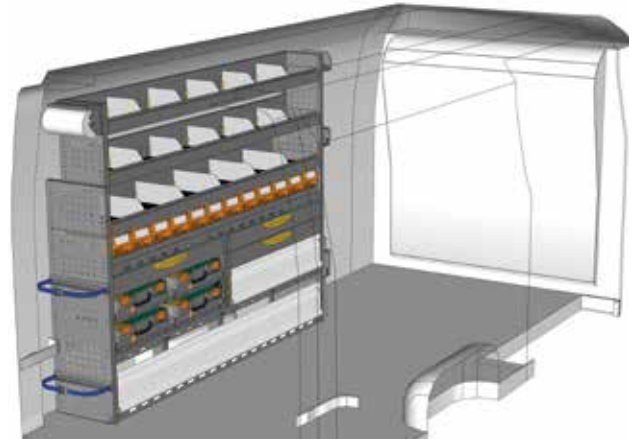
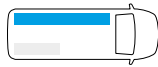

BEISPIEL - EXAMPLE

MA 2016 P2*

B=2032 T=365 H=1600 mm - W=2032 D=365 H=1600 mm

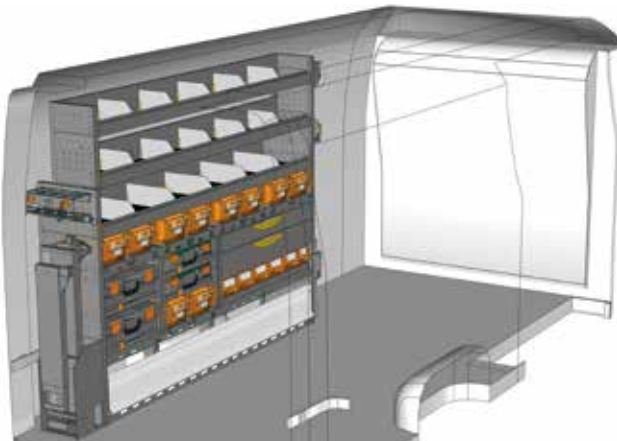

BEISPIEL - EXAMPLE

MA 2016 P3*

B=2032 T=365 H=1600 mm - W=2032 D=365 H=1600 mm

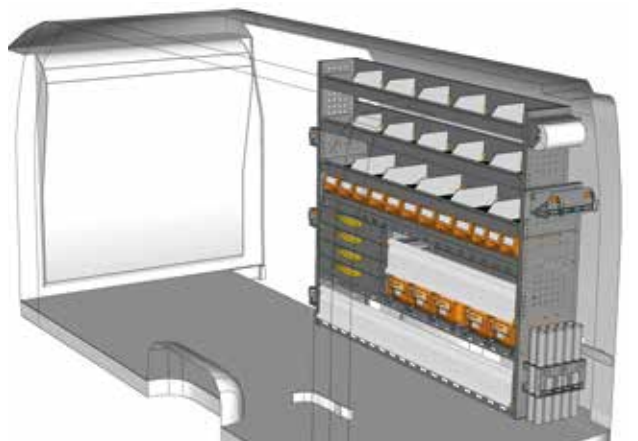
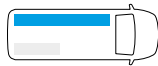

BEISPIEL - EXAMPLE

MA 1916 P1*

B=1942 T=365 H=1600 mm - W=1942 D=365 H=1600 mm

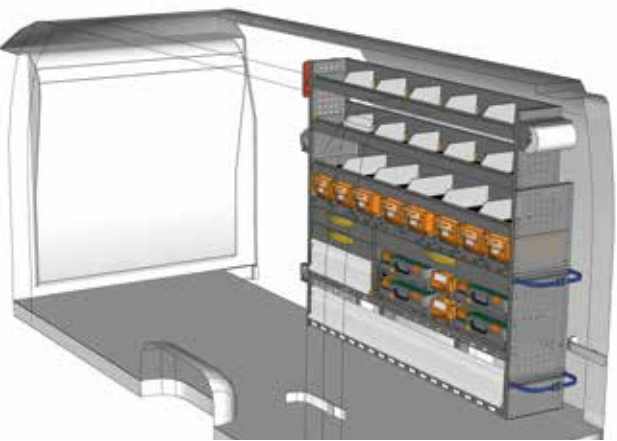
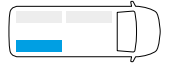

BEISPIEL - EXAMPLE

MA 1916 P2*

B=1942 T=365 H=1600 mm - W=1942 D=365 H=1600 mm

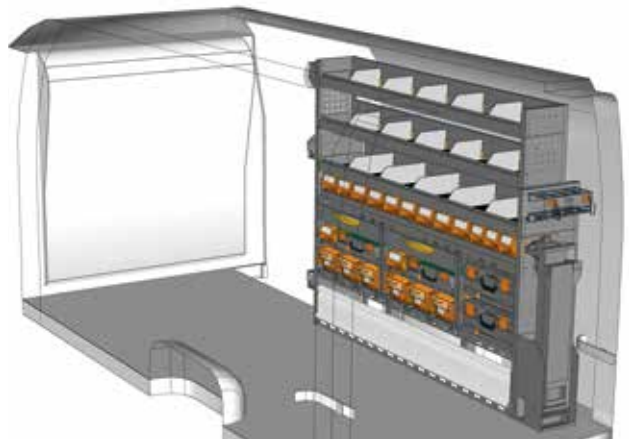
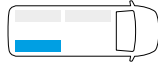

BEISPIEL - EXAMPLE

MA 1916 P3*

B=1942 T=365 H=1600 mm - W=1942 D=365 H=1600 mm

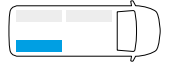

* Einschließlich Befestigungskit - Fixing kit included

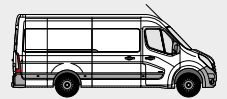

FAHRZEUGEINRICHTUNGSBEISPIELE - FITTINGS EXAMPLES

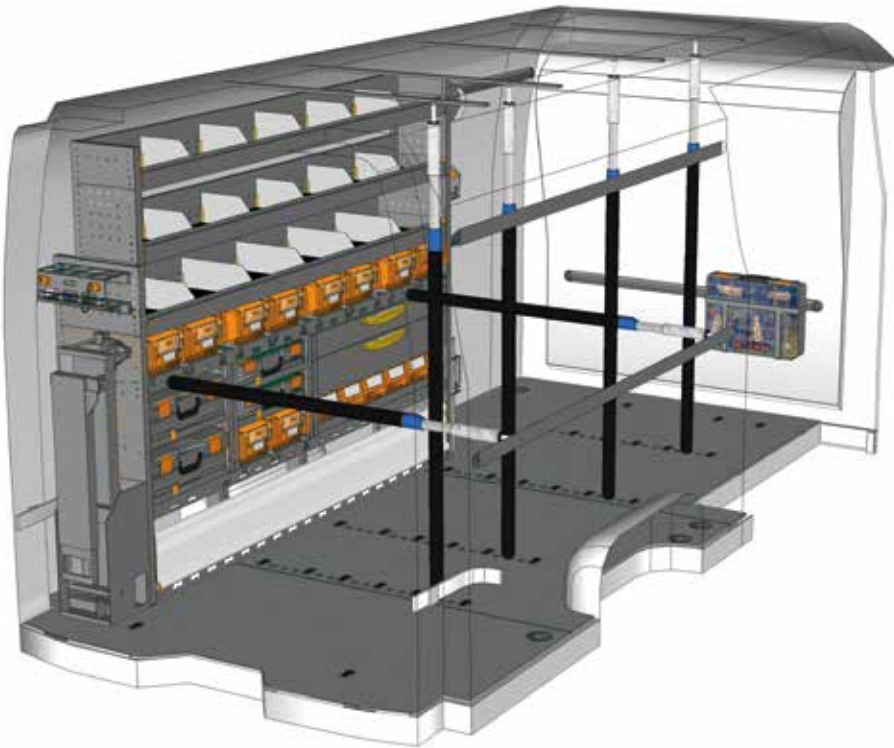

BEISPIEL - EXAMPLE

EXAMPLE MA L2LH2 P1*



1 x MA 2016 P3	4 x V18025 15
1 x MA 2LG1 J0	1 x B0X080
1 x V22585	1 x CPV080
2 x V22131	2 x V22136
4 x V22017	2 x V22124
3 x V18029 15	2 x V22148
2 x V18029 20	1 x YELLOW
10 x V22106	4 x V225820

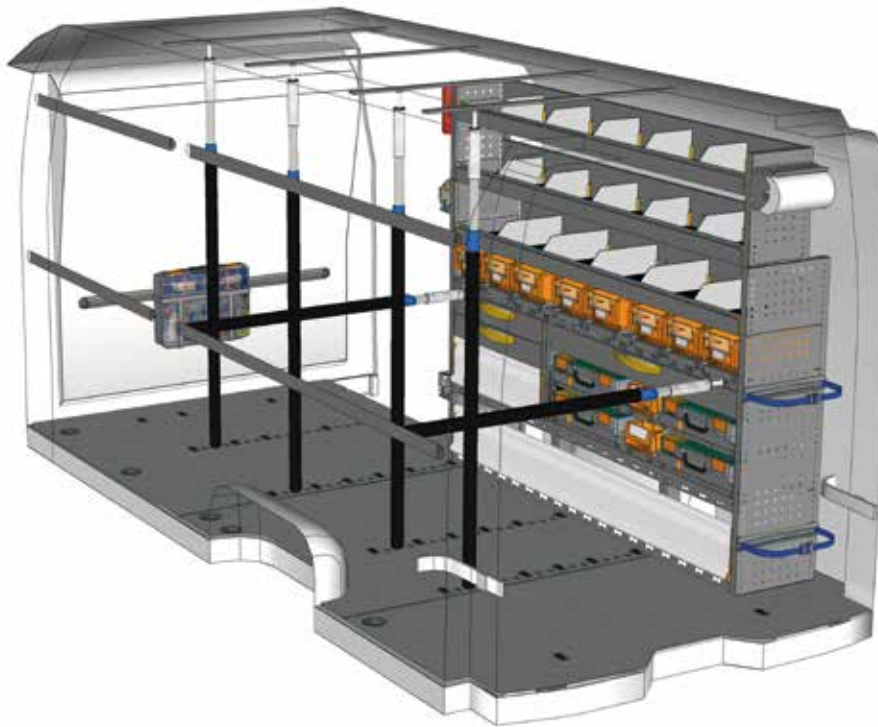

BEISPIEL - EXAMPLE

EXAMPLE MA L2LH2 P2*



1 x MA 1916 P2	4 x V18025 15
1 x MA 2LG1 J0	1 x B0X080
1 x V22585	1 x CPV080
2 x V22131	2 x V22136
4 x V22017	2 x V22124
3 x V18029 15	2 x V22148
2 x V18029 20	1 x YELLOW
10 x V22106	4 x V225820

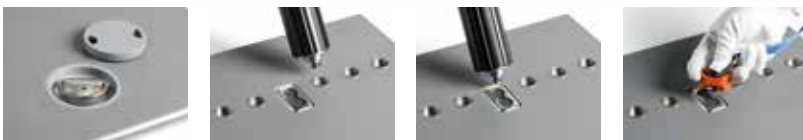

siehe Seiten 10/11
see pages 10/11

* Einschließlich Befestigungskit - Fixing kit included

KASTENWAGEN - PANEL VAN
NISSAN NV400

PROFESSIONAL

**Haben Sie Ihre Einrichtung nicht gefunden?
Verlassen Sie sich auf die Profis für
Fahrzeugeinrichtungen.**

Auf der Rückseite dieses Katalogs
finden Sie die nächstgelegene
StoreVan Niederlassung.
Besuchen Sie unsere Web-Seite.

**Didn't find the equipment
you're looking for?
Leave it to our experts.**

See the back of this catalogue
and contact the nearest
StoreVan point or visit our website.





NISSAN NV400
KASTENWAGEN - PANEL VAN

MOBILE



**Nicht nur
Fahrzeug,
sondern auch
Mobilität**

All-out
mobility



Die Lösung MOBILE ergänzt die Store Van Nutzfahrzeugeinrichtungen mit den Kleinteilekoffern der Serie STORE BOX 102 – 136 – 238 und den dazugehörigen Wagen, der den Benutzer der **mobilen Werkstatt** beim Transport der Waren und Ausrüstung vom Fahrzeug zur Arbeitsstelle unterstützt. Die neuen „Airline“ Verankerungselemente erhöhen die Stabilität des Moduls, ohne sein Gewicht zu beeinflussen. Auch in diesem Fall werden in den Regalen Elemente eingebaut, die eine Nutzung der „Airline“ Festhaltesysteme ermöglichen. Auch dank der Einführung der Bodenplatte SAFETY FLOOR können sowohl vertikale als auch horizontale Ladungssicherungssysteme gewählt werden.

The **MOBILE equipment solution** integrates Store Van fittings for commercial vehicles with small-parts cases, series STORE BOX 102 – 136 – 238, and trolleys by which **mobile workshop** users can easily carry their goods and tools from their van to the workplace.

The new “Airline” anchoring fittings improve the stability of modules with no weight increase. Here shelving units are integrated with elements where “Airline” anchoring systems can easily fit. Both vertical and horizontal load restraining elements can be installed in your van thanks to the new SAFETY FLOOR flooring panels.





FAHRZEUGEINRICHTUNGSBEISPIELE - FITTINGS EXAMPLES

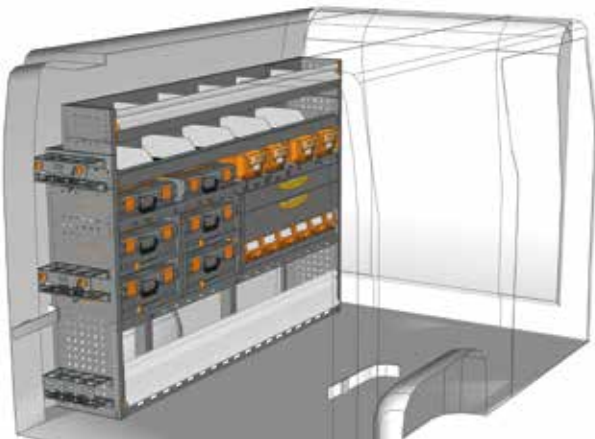

BEISPIEL - EXAMPLE

MA 2014 M1*

B=2032 T=365 H=1400 mm - W=2032 D=365 H=1400 mm

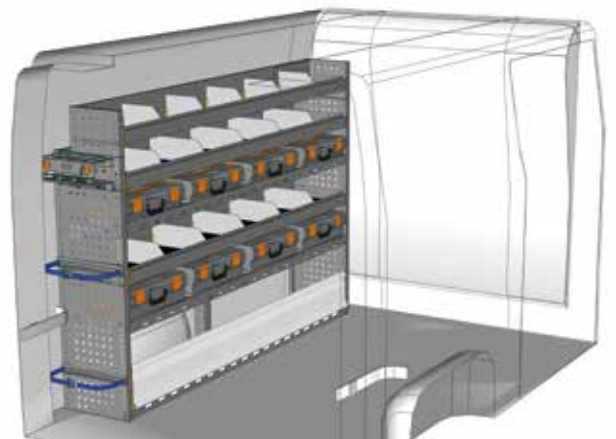
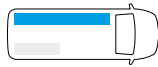

BEISPIEL - EXAMPLE

MA 2014 M2*

B=2032 T=365 H=1400 mm - W=2032 D=365 H=1400 mm

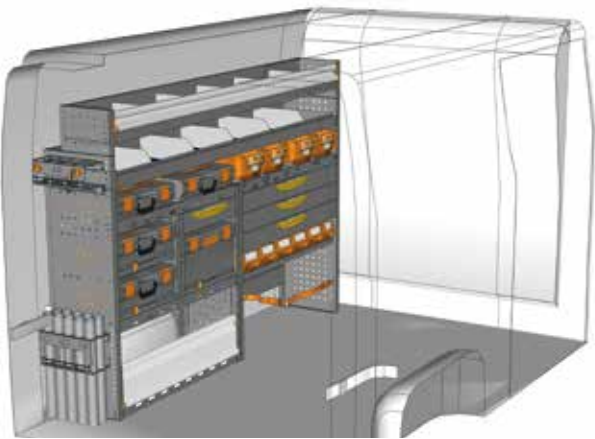

BEISPIEL - EXAMPLE

MA 2014 M3*

B=2032 T=365 H=1400 mm - W=2032 D=365 H=1400 mm

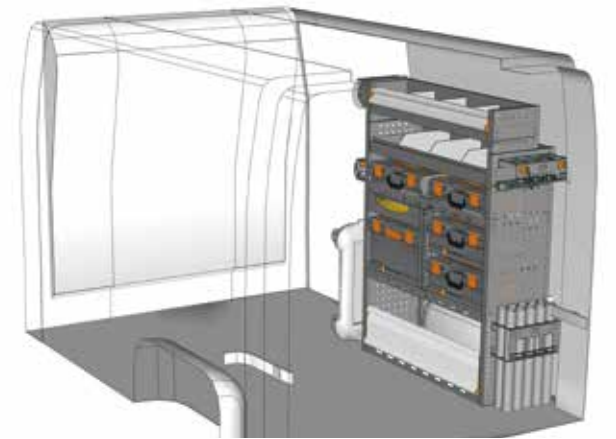
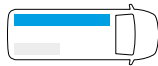

BEISPIEL - EXAMPLE

MA 1014 M1*

B=1016 T=365 H=1400 mm - W=1016 D=365 H=1400 mm

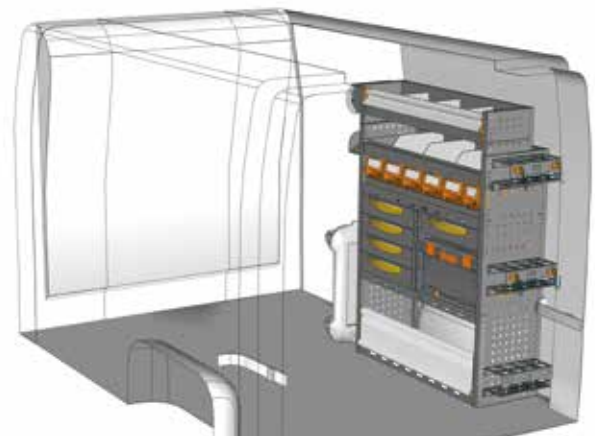
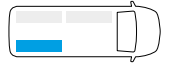

BEISPIEL - EXAMPLE

MA 1014 M2*

B=1016 T=365 H=1400 mm - W=1016 D=365 H=1400 mm

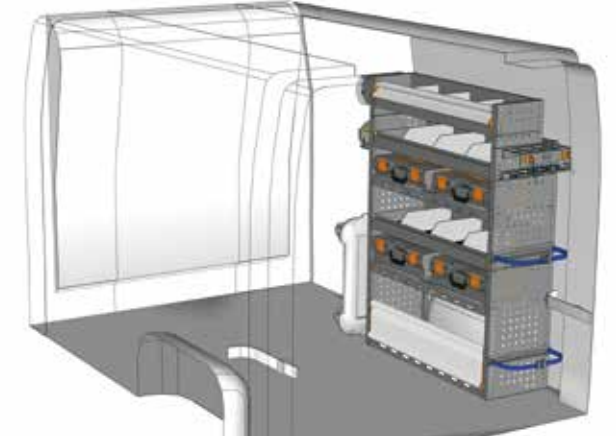
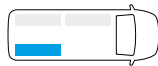

BEISPIEL - EXAMPLE

MA 1014 M3*

B=1016 T=365 H=1400 mm - W=1016 D=365 H=1400 mm

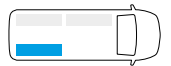

* Einschließlich Befestigungskit - Fixing kit included



FAHRZEUGEINRICHTUNGSBEISPIELE - FITTINGS EXAMPLES

KASTENWAGEN - PANEL VAN
NISSAN NV400

MOBILE

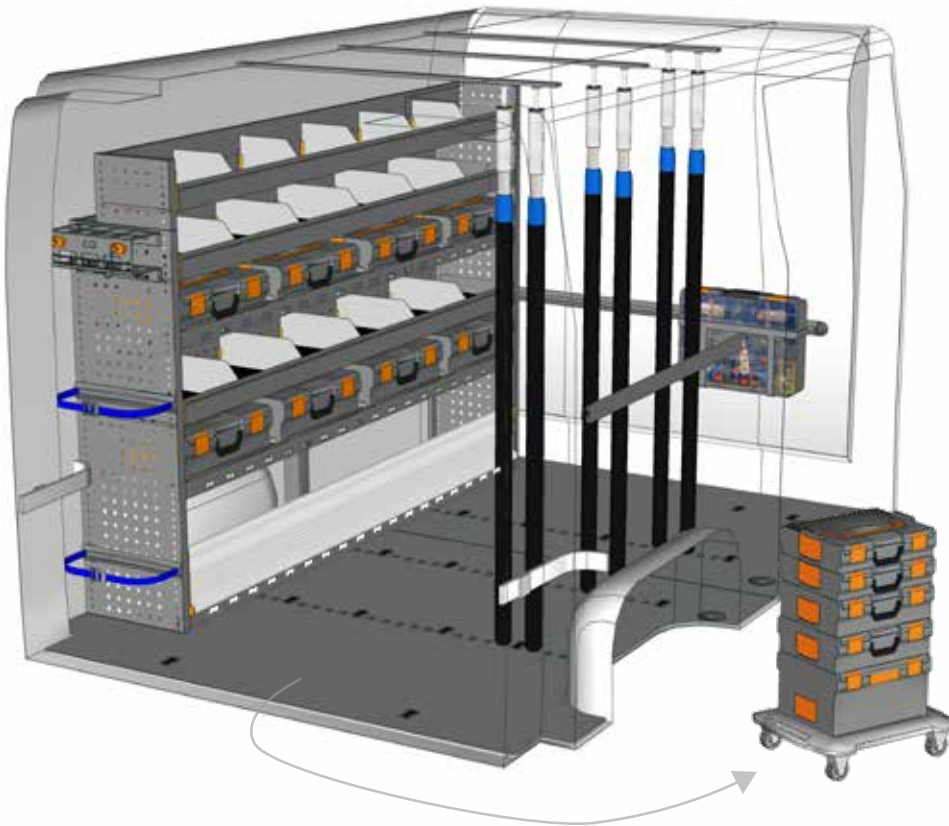

BEISPIEL - EXAMPLE

EXAMPLE MA L1H1 M1*



- | | |
|----------------|-------------|
| 1 x MA 2014 M2 | 1 x BOX080 |
| 1 x MA 10G1 A0 | 1 x CPV080 |
| 1 x V22585 | 2 x V22136 |
| 6 x V22017 | 2 x V22124 |
| 1 x V18029 15 | 2 x V22148 |
| 1 x V18029 10 | 1 x YELLOW |
| 4 x V22106 | 4 x V225820 |
| 3 x V18025 15 | |

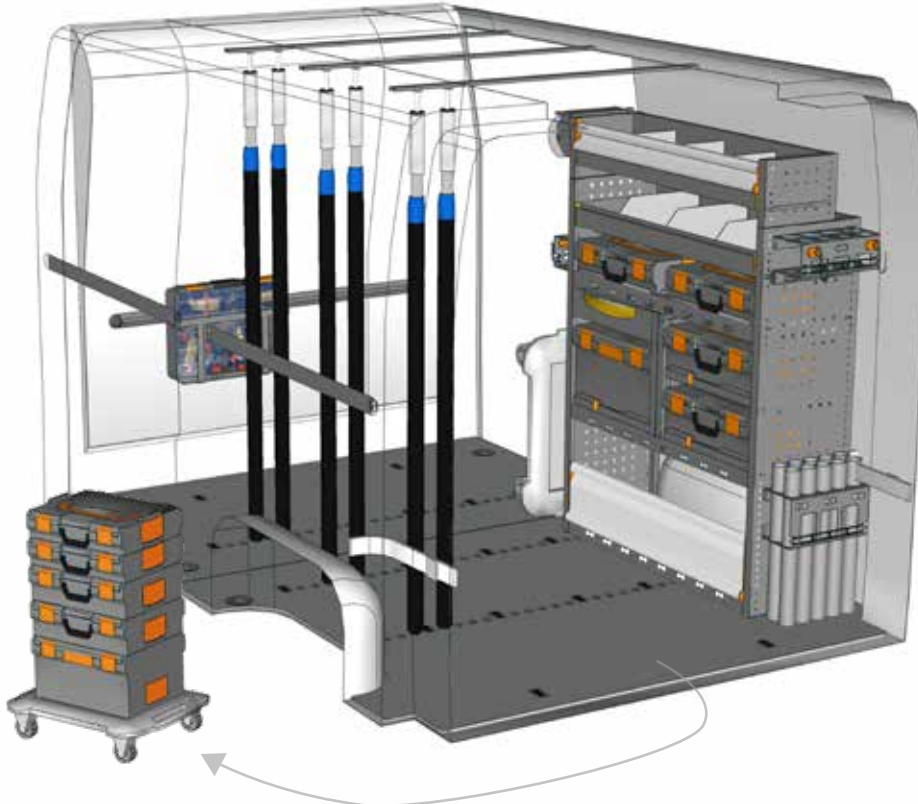

BEISPIEL - EXAMPLE

EXAMPLE MA L1H1 M2*



- | | |
|----------------|-------------|
| 1 x MA 1014 M1 | 1 x BOX080 |
| 1 x MA 10G1 A0 | 1 x CPV080 |
| 1 x V22585 | 2 x V22136 |
| 6 x V22017 | 2 x V22124 |
| 2 x V18029 10 | 2 x V22148 |
| 1 x V18029 15 | 1 x YELLOW |
| 6 x V22106 | 4 x V225820 |
| 3 x V18025 15 | |

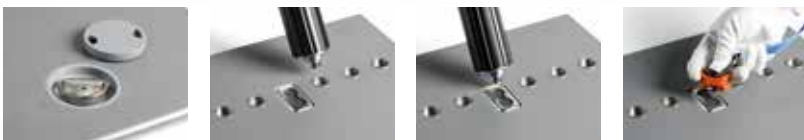

siehe Seiten 10/11
see pages 10/11

* Einschließlich Befestigungskit - Fixing kit included

Haben Sie Ihre Einrichtung nicht gefunden?
Verlassen Sie sich auf die Profis für Fahrzeugeinrichtungen.
Auf der Rückseite dieses Katalogs finden Sie die nächstgelegene StoreVan Niederlassung. Besuchen Sie unsere Web-Seite.

Didn't find the equipment you're looking for?
Leave it to our experts.
See the back of this catalogue and contact the nearest StoreVan point or visit our website.



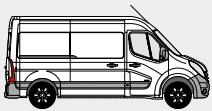

FAHRZEUGEINRICHTUNGSBEISPIELE - FITTINGS EXAMPLES

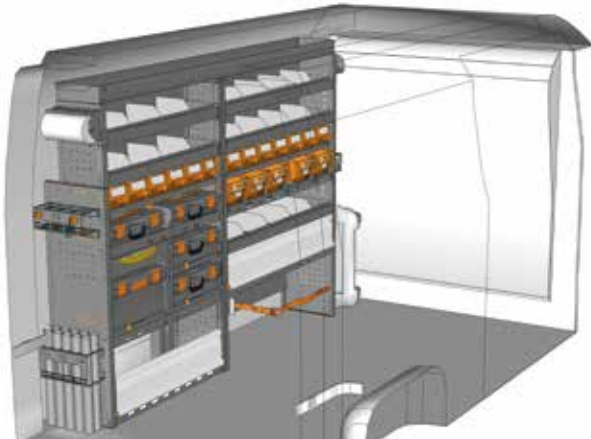

BEISPIEL - EXAMPLE

MA 2217 M1*

B=2241 T=365 H=1690 mm - W=2241 D=365 H=1690 mm

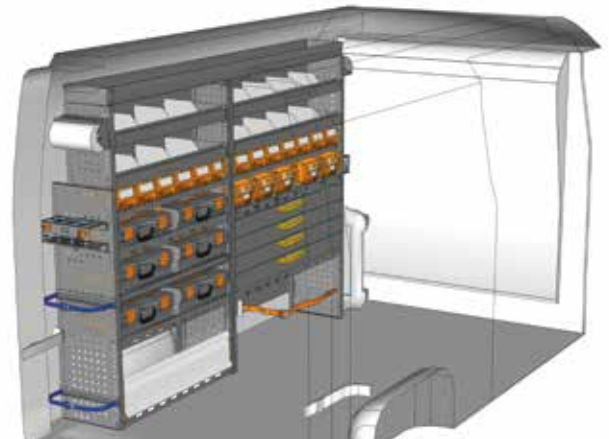
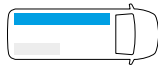

BEISPIEL - EXAMPLE

MA 2217 M2*

B=2241 T=365 H=1690 mm - W=2241 D=365 H=1690 mm

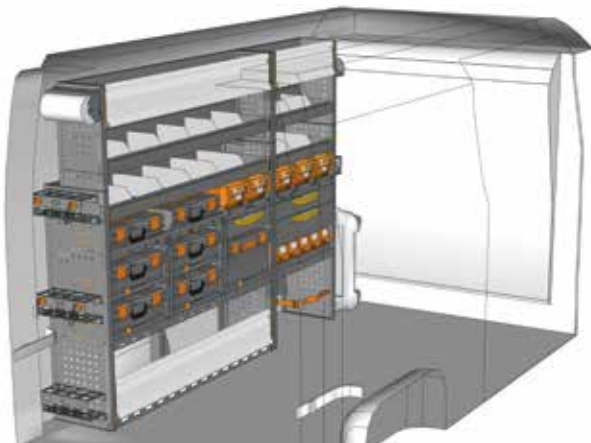
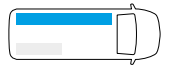

BEISPIEL - EXAMPLE

MA 2217 M3*

B=2241 T=365 H=1700 mm - W=2241 D=365 H=1700 mm

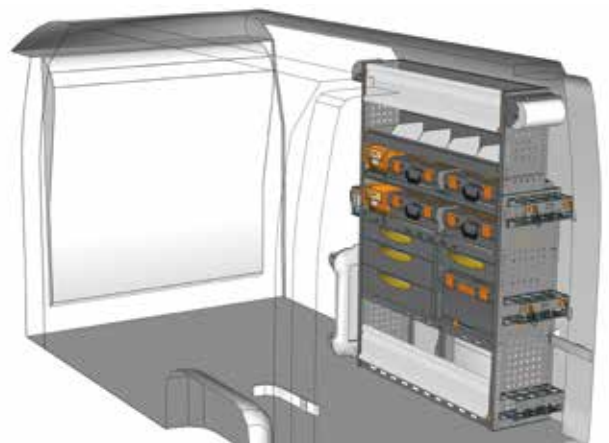
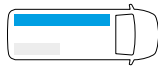

BEISPIEL - EXAMPLE

MA 1217 M1*

B=1225 T=365 H=1700 mm - W=1225 D=365 H=1700 mm

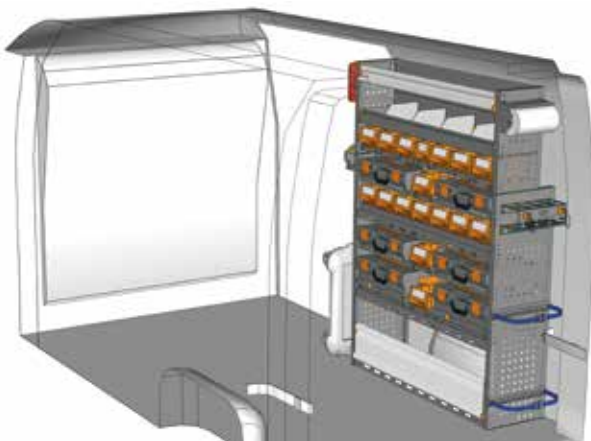
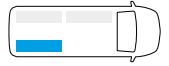

BEISPIEL - EXAMPLE

MA 1217 M2*

B=1225 T=365 H=1700 mm - W=1225 D=365 H=1700 mm

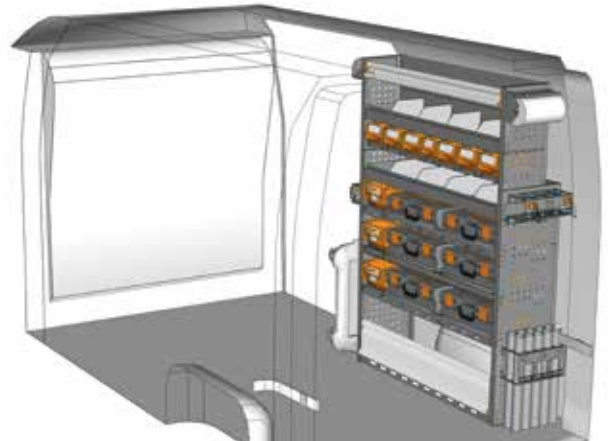
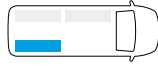

BEISPIEL - EXAMPLE

MA 1217 M3*

B=1225 T=365 H=1700 mm - W=1225 D=365 H=1700 mm

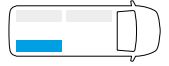

* Einschließlich Befestigungsset - Fixing kit included

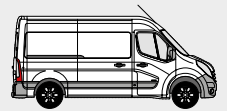

FAHRZEUGEINRICHTUNGSBEISPIELE - FITTINGS EXAMPLES

KASTENWAGEN - PANEL VAN
NISSAN NV400

MOBILE

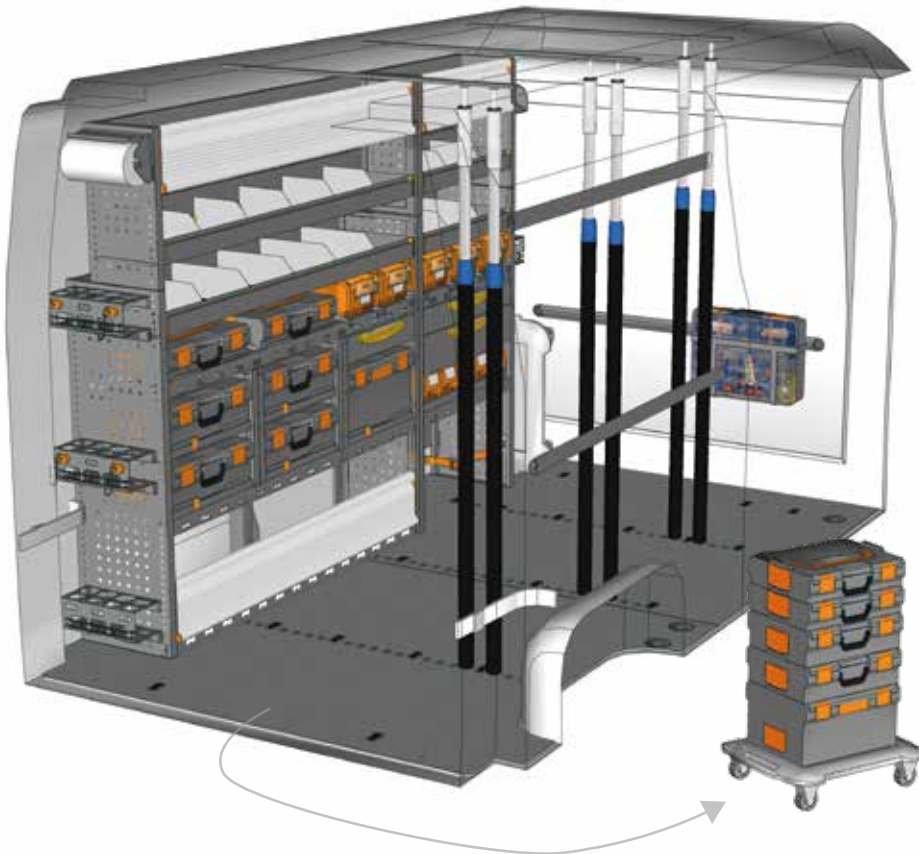

BEISPIEL - EXAMPLE

EXAMPLE MA L2H2 M1*



- | | |
|----------------|-------------|
| 1 x MA 2217 M3 | 1 x CPV080 |
| 1 x MA 20G1 A0 | 2 x V22136 |
| 1 x V22585 | 2 x V22124 |
| 6 x V22017 | 2 x V22148 |
| 3 x V18029 15 | 1 x YELLOW |
| 6 x V22106 | 4 x V225820 |
| 3 x V18025 15 | |
| 1 x BOX080 | |

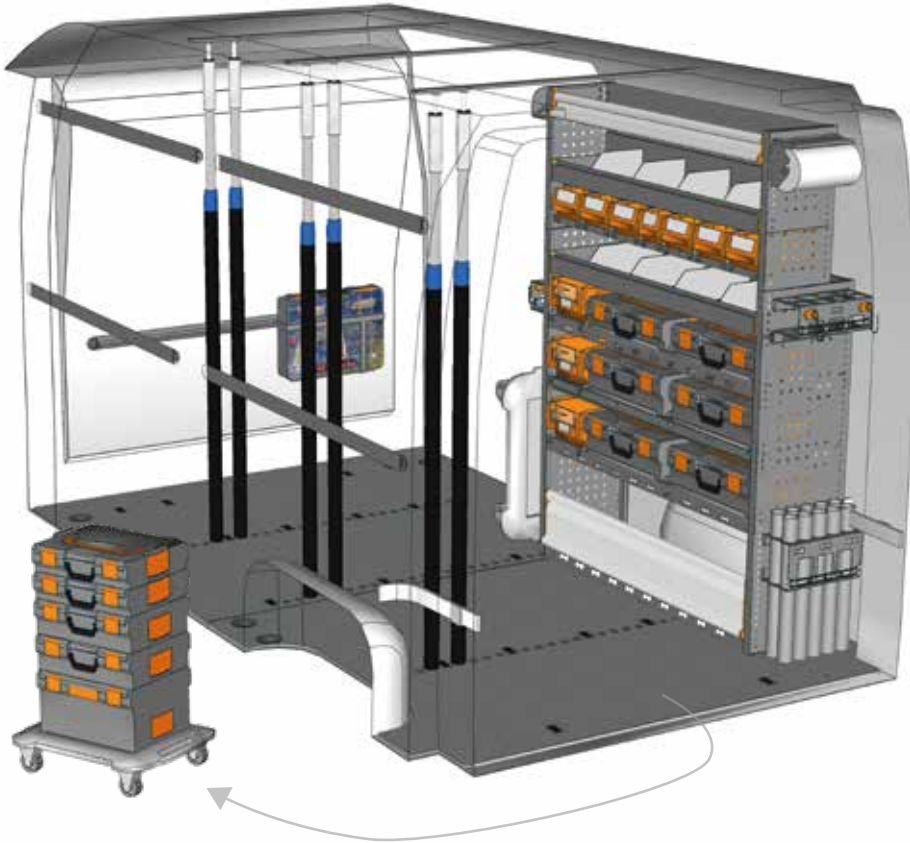

BEISPIEL - EXAMPLE

EXAMPLE MA L2H2 M2*



- | | |
|----------------|-------------|
| 1 x MA 1217 M3 | 1 x CPV080 |
| 1 x MA 20G1 A0 | 2 x V22136 |
| 1 x V22585 | 2 x V22124 |
| 6 x V22017 | 2 x V22148 |
| 5 x V18029 15 | 1 x YELLOW |
| 10 x V22106 | 4 x V225820 |
| 3 x V18025 15 | |
| 1 x BOX080 | |

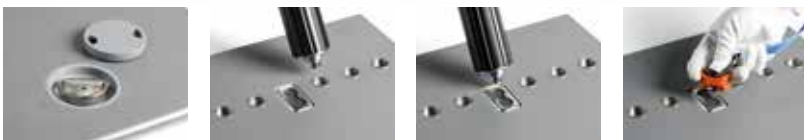

siehe Seiten 10/11
see pages 10/11

* Einschließlich Befestigungskit - Fixing kit included

Haben Sie Ihre Einrichtung nicht gefunden?
Verlassen Sie sich auf die Profis für Fahrzeugeinrichtungen.
Auf der Rückseite dieses Katalogs finden Sie die nächstgelegene StoreVan Niederlassung. Besuchen Sie unsere Web-Seite.

Didn't find the equipment you're looking for?
Leave it to our experts.
See the back of this catalogue and contact the nearest StoreVan point or visit our website.



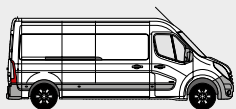

FAHRZEUGEINRICHTUNGSBEISPIELE - FITTINGS EXAMPLES

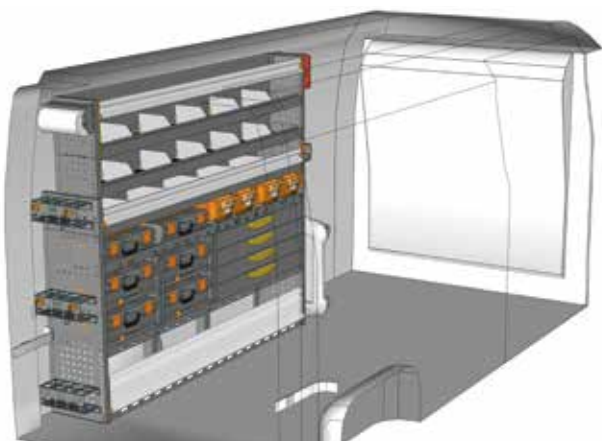

BEISPIEL - EXAMPLE

MA 2017 M1*

B=2032 T=365 H=1700 mm - W=2032 D=365 H=1700 mm

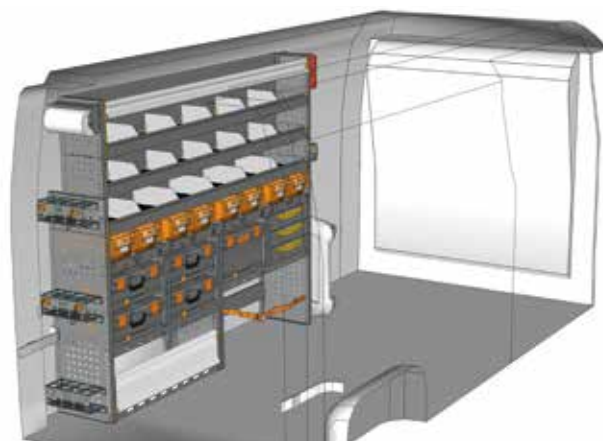
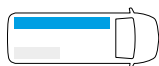

BEISPIEL - EXAMPLE

MA 2017 M2*

B=2032 T=365 H=1700 mm - W=2032 D=365 H=1700 mm

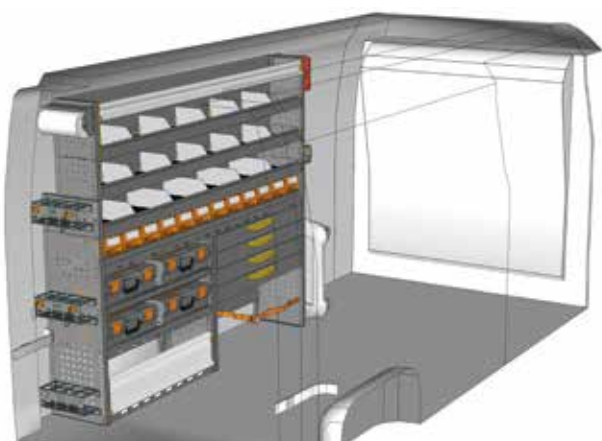
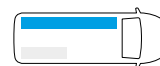

BEISPIEL - EXAMPLE

MA 2017 M3*

B=2032 T=365 H=1700 mm - W=2032 D=365 H=1700 mm

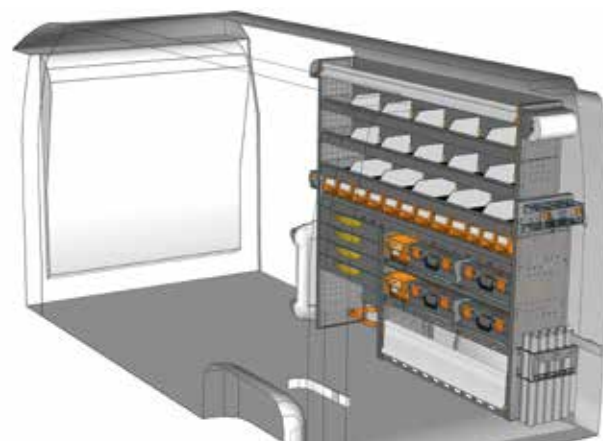
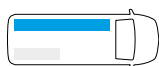

BEISPIEL - EXAMPLE

MA 1917 M1*

B=1942 T=365 H=1700 mm - W=1942 D=365 H=1700 mm

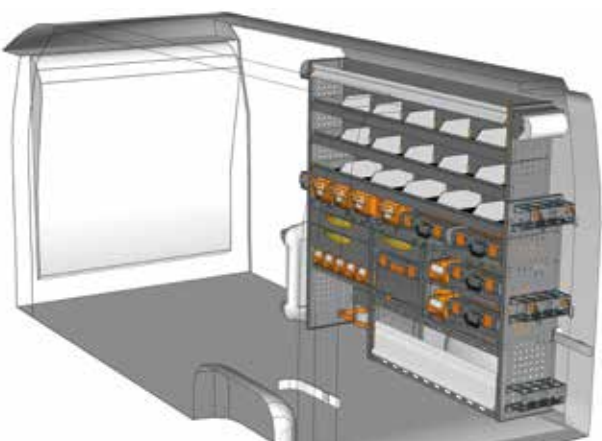
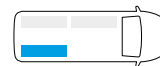

BEISPIEL - EXAMPLE

MA 1917 M2*

B=1942 T=365 H=1700 mm - W=1942 D=365 H=1700 mm

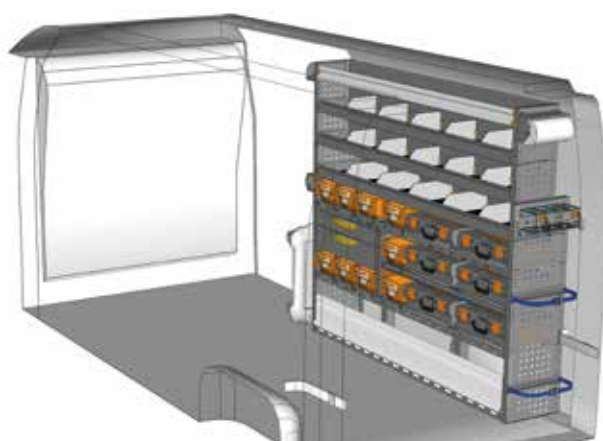
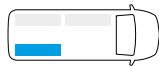

BEISPIEL - EXAMPLE

MA 1917 M3*

B=1942 T=365 H=1700 mm - W=1942 D=365 H=1700 mm

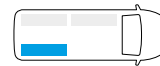

* Einschließlich Befestigungskit - Fixing kit included

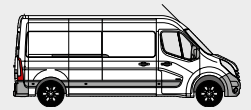

FAHRZEUGEINRICHTUNGSBEISPIELE - FITTINGS EXAMPLES

KASTENWAGEN - PANEL VAN
NISSAN NV400

MOBILE

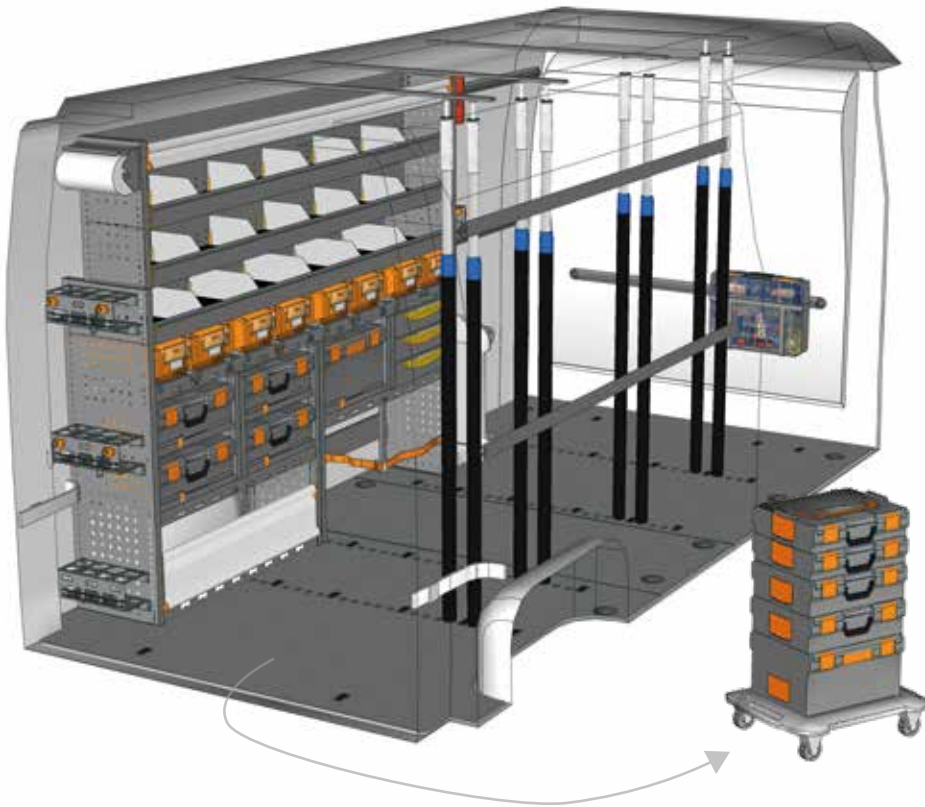

BEISPIEL - EXAMPLE

EXAMPLE MA L3H2 M1*



- | | |
|----------------|-------------|
| 1 x MA 2017 M2 | 1 x BOX080 |
| 1 x MA 30G1 A0 | 1 x CPV080 |
| 1 x V22585 | 2 x V22136 |
| 8 x V22017 | 2 x V22124 |
| 3 x V18029 15 | 2 x V22148 |
| 2 x V18029 20 | 1 x YELLOW |
| 10 x V22106 | 4 x V225820 |
| 4 x V18025 15 | |

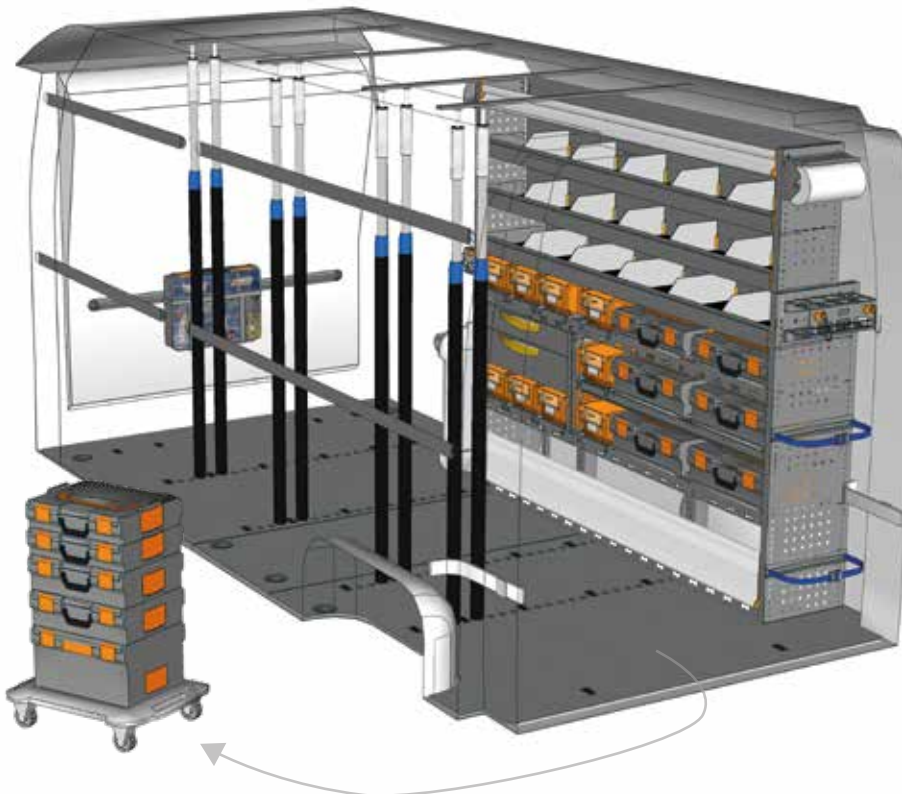

BEISPIEL - EXAMPLE

EXAMPLE MA L3H2 M2*



- | | |
|----------------|-------------|
| 1 x MA 1917 M3 | 1 x BOX080 |
| 1 x MA 30G1 A0 | 1 x CPV080 |
| 1 x V22585 | 2 x V22136 |
| 8 x V22017 | 2 x V22124 |
| 3 x V18029 15 | 2 x V22148 |
| 2 x V18029 20 | 1 x YELLOW |
| 10 x V22106 | 4 x V225820 |
| 4 x V18025 15 | |

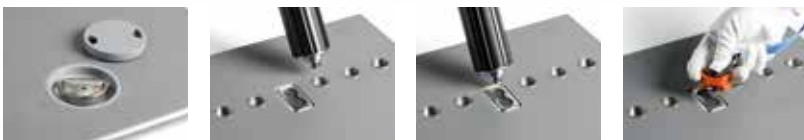

siehe Seiten 10/11
see pages 10/11

* Einschließlich Befestigungskit - Fixing kit included

Haben Sie Ihre Einrichtung nicht gefunden?
Verlassen Sie sich auf die Profis für Fahrzeugeinrichtungen.
Auf der Rückseite dieses Katalogs finden Sie die nächstgelegene StoreVan Niederlassung. Besuchen Sie unsere Web-Seite.

Didn't find the equipment you're looking for?
Leave it to our experts.
See the back of this catalogue and contact the nearest StoreVan point or visit our website.



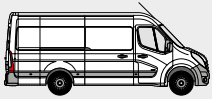

FAHRZEUGEINRICHTUNGSBEISPIELE - FITTINGS EXAMPLES

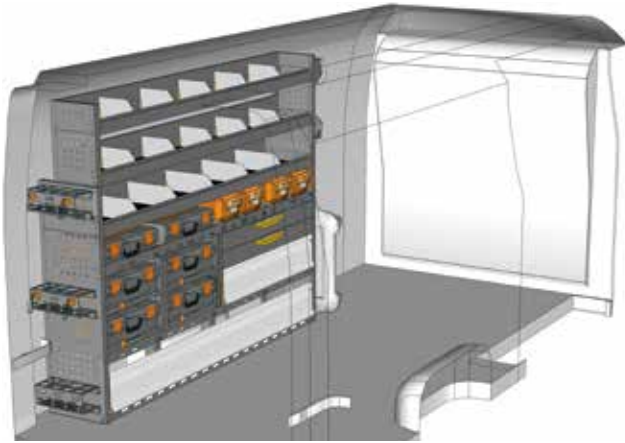

BEISPIEL - EXAMPLE

MA 2016 M1*

B=2032 T=365 H=1600 mm - W=2032 D=365 H=1600 mm

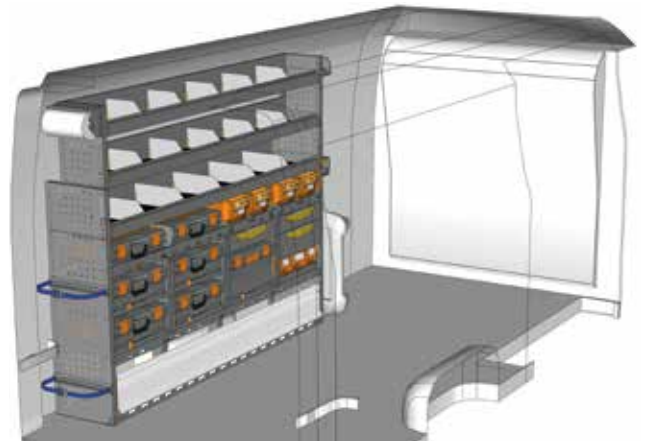
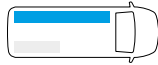

BEISPIEL - EXAMPLE

MA 2016 M2*

B=2032 T=365 H=1600 mm - W=2032 D=365 H=1600 mm

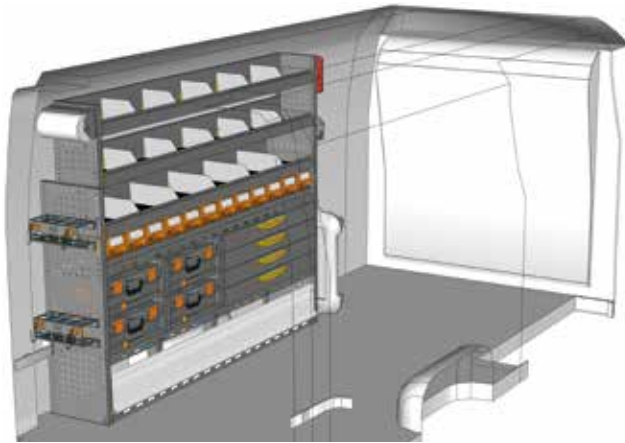

BEISPIEL - EXAMPLE

MA 2016 M3*

B=2032 T=365 H=1600 mm - W=2032 D=365 H=1600 mm

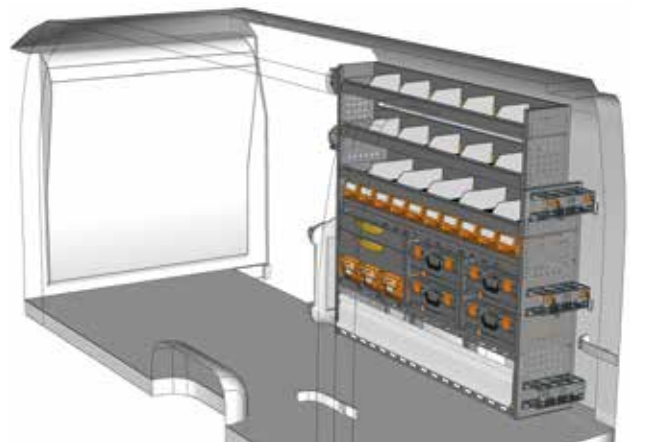
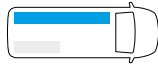

BEISPIEL - EXAMPLE

MA 1716 M1*

B=1733 T=365 H=1600 mm - W=1733 D=365 H=1600 mm

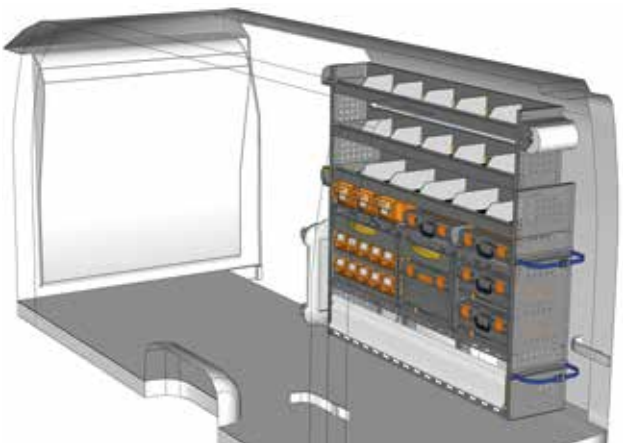
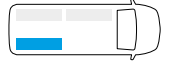

BEISPIEL - EXAMPLE

MA 1716 M2*

B=1733 T=365 H=1600 mm - W=1733 D=365 H=1600 mm

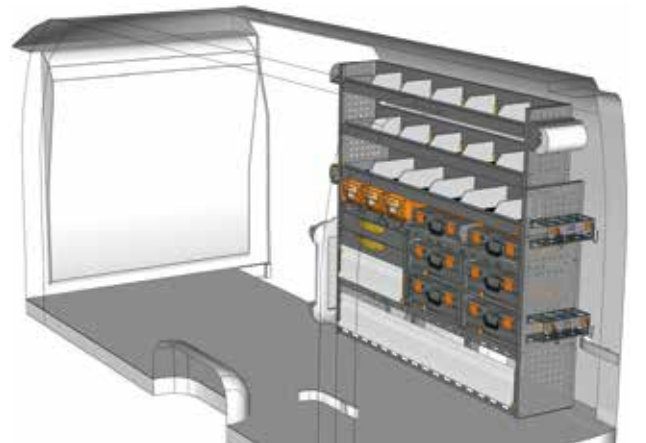
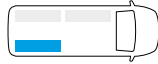

BEISPIEL - EXAMPLE

MA 1716 M3*

B=1733 T=365 H=1600 mm - W=1733 D=365 H=1600 mm



* Einschließlich Befestigungskit - Fixing kit included

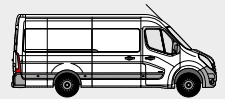

FAHRZEUGEINRICHTUNGSBEISPIELE - FITTINGS EXAMPLES

KASTENWAGEN - PANEL VAN
NISSAN NV400

MOBILE

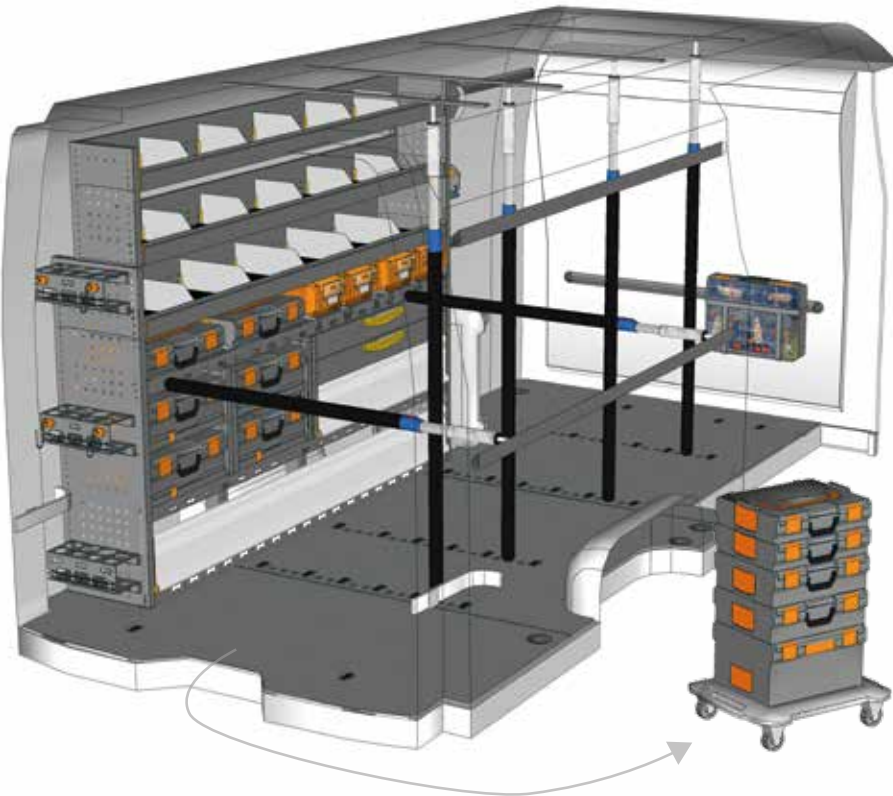

BEISPIEL - EXAMPLE

EXAMPLE MA L2LH2 M1*



- | | |
|----------------|---------------|
| 1 x MA 2016 M1 | 4 x V18025 15 |
| 1 x MA 2LG1 J0 | 1 x BOX080 |
| 1 x V22585 | 1 x CPV080 |
| 2 x V22131 | 2 x V22136 |
| 4 x V22017 | 2 x V22124 |
| 3 x V18029 15 | 2 x V22148 |
| 2 x V18029 20 | 1 x YELLOW |
| 10 x V22106 | 4 x V225820 |

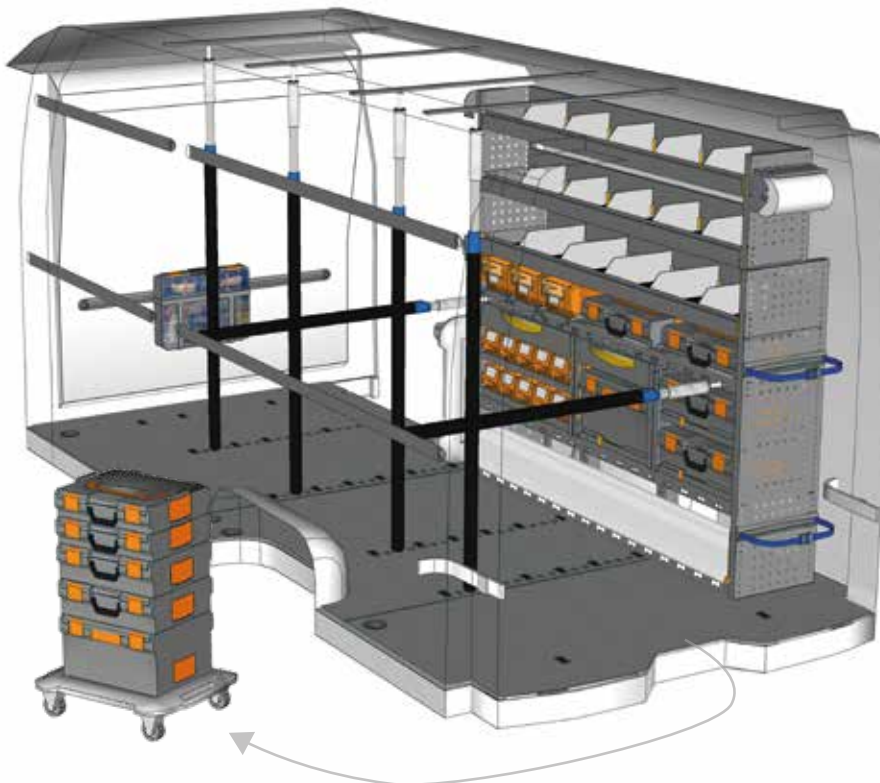

BEISPIEL - EXAMPLE

EXAMPLE MA L2LH2 M2*



- | | |
|----------------|---------------|
| 1 x MA 1716 M2 | 4 x V18025 15 |
| 1 x MA 2LG1 J0 | 1 x BOX080 |
| 1 x V22585 | 1 x CPV080 |
| 2 x V22131 | 2 x V22136 |
| 4 x V22017 | 2 x V22124 |
| 3 x V18029 15 | 2 x V22148 |
| 2 x V18029 20 | 1 x YELLOW |
| 10 x V22106 | 4 x V225820 |

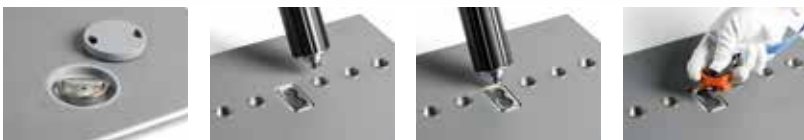

siehe Seiten 10/11
see pages 10/11

* Einschließlich Befestigungskit - Fixing kit included

Haben Sie Ihre Einrichtung nicht gefunden?
Verlassen Sie sich auf die Profis für Fahrzeugeinrichtungen.
Auf der Rückseite dieses Katalogs finden Sie die nächstgelegene StoreVan Niederlassung. Besuchen Sie unsere Web-Seite.

Didn't find the equipment you're looking for?
Leave it to our experts.
See the back of this catalogue and contact the nearest StoreVan point or visit our website.





FAHRZEUG VEHICLE	DACHTRÄGER ROOF RACK	ABMESSUNGEN DIMENSIONS	GEWICHT WEIGHT	TRAGKRAFT LOAD CAPACITY
	ART.			
Fahrzeugtyp - Model L1 H1	POT 219	2750x1700 mm	33,44 kg	166,00 kg
Fahrzeugtyp - Model L1 H2	POT 220	3000x1600 mm	33,23 kg	166,00 kg
Fahrzeugtyp - Model L2 H2	POT 214	3400x1600 mm	34,81 kg	165,00 kg
Fahrzeugtyp - Model L3 H2	POT 215	4000x1600 mm	40,59 kg	159,00 kg
Fahrzeugtyp - Model L4 H2	POT 216	4350x1600 mm	45,80 kg	154,00 kg

POT

- Dachträger bestehend aus:
 - Alu-Querschienen inkl. Befestigungen und Gummiprofilen
 - Seitenwänden aus Aluminium
 - Laderolle aus Aluminium
 - Schraubmaterial aus Edelstahl
- Roof rack complete of:
 - aluminium crossbars with fixing parts and rubber profile
 - aluminium side rails
 - aluminium loading roller
 - fixing screws in stainless steel



FAHRZEUG VEHICLE	LEITERTRÄGER LADDER RACK	ABMESSUNGEN DIMENSIONS	GEWICHT WEIGHT	TRAGKRAFT LOAD CAPACITY
	ART.			
Fahrzeugtyp - Model L1 H1	POS 219	2750x1680 mm	61,35 kg	138,00 kg
Fahrzeugtyp - Model L1 H2	POS 220	3000x1580 mm	60,61 kg	139,00 kg
Fahrzeugtyp - Model L2 H2	POS 214	3400x1580 mm	64,30 kg	135,00 kg
Fahrzeugtyp - Model L3 H2	POS 215	4000x1580 mm	69,08 kg	131,00 kg
Fahrzeugtyp - Model L4 H2	POS 216	4350x1580 mm	73,56 kg	126,00 kg

POS

- Leiterträger bestehend aus:
 - Alu-Querschienen inkl. Befestigungen und Gummiprofilen
 - Seitenwand aus Aluminium
 - Laderolle aus Aluminium
 - Leiterschiene aus Aluminium und Edelstahl
 - Schraubmaterial aus Edelstahl
- Ladder rack complete of:
 - aluminium crossbars with fixing parts and rubber profile
 - aluminium side rail
 - aluminium loading roller
 - ladder rack rail made of aluminium and stainless steel
 - fixing screws in stainless steel







ART. NR. / ITEM NO. **PAP 265 00**

- Papierrollenhalter mit Papierrolle Ø 130 mm
- Paper towel holder kit with paper towel Ø 130 mm



ART. NR. / ITEM NO. **CAB 220 00**

- Schlauchhalter
- Cable saddle



ART. NR. / ITEM NO. **SPR 365 00**

- Spraydosenhalter T=365 mm
- Spray-can holder kit D=365 mm



ART. NR. / ITEM NO. **PAP 365 00**

- Papierrollenhalter mit Papierrolle Ø 240 mm
- Paper towel holder kit with paper towel Ø 240 mm



ART. NR. / ITEM NO. **CAB 296 00**

- Schlauchhalter-Satz
- Cable saddle-kit



ART. NR. / ITEM NO. **SIL 296 00**

- Kartuschen - Spraydosen halter
- Kit silicone - spray cans holder



ART. NR. / ITEM NO. **LED 001 00**

- Led Lampe IP20 12V B=600 mm
- Led lamp IP20 12V W=600 mm



ART. NR. / ITEM NO. **WAS 365 00**

- Handwash Kit
- Hand wash kit



ART. NR. / ITEM NO. **AID 265 00**

- Verbandkasten
- First aid kit



ART. NR. / ITEM NO. **DOC 265 00**

- Plantasche DIN A4
- DIN A4 documents holder



ART. NR. / ITEM NO. **MAG 020**

- Magnetensatz 10 Stk Ø 20 mm
- Set of 10 magnets Ø 20 mm

ART. NR. / ITEM NO. **MAG 025**

- Magnetensatz 10 Stk Ø 25 mm
- Set of 10 magnets Ø 25 mm



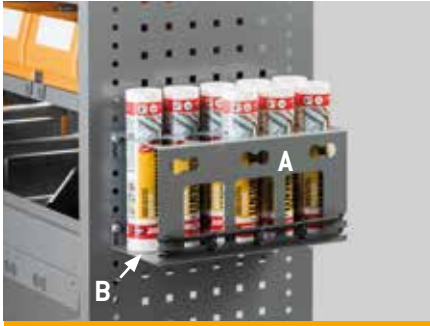

ART. NR. / ITEM NO. **BAR 296 00** A

- Gewindestangenhalter-Satz
- Threaded-bar holder kit

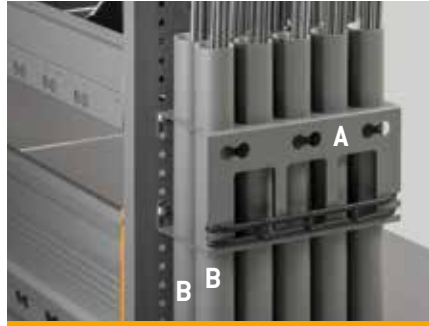

ART. NR. / ITEM NO. **BAR 296 00** A

- Gewindestangenhalter-Satz
- Threaded-bar holder kit

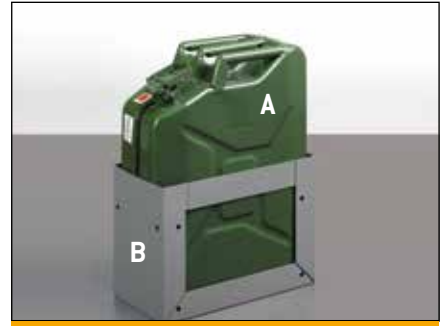

ART. NR. / ITEM NO. **OIL 20L 00** A

- Stahlkanister inhalt 20 LT
- Metal can capacity 20 LT

ART. NR. / ITEM NO. **BAR 296 02** B

- Adapter für Silikon-Kartuschen
- Adapter for silicone cartridges

ART. NR. / ITEM NO. **BAR 296 01** B

- 5 Rohren-satz für Gewindestangenhalter
- 5 Pipe-kit for threaded-bar holder

ART. NR. / ITEM NO. **OIL 365 00** B

- Kanisterhalter
- Can holder



ART. NR. / ITEM NO. **BL 7433 00** A

- Behälterschiene für 1 Behälter gröÙe 1PL
- Container rail for 1 container size 1PL



ART. NR. / ITEM NO. **BL 7434 00** A

- Behälterschiene für 3 Behälter gröÙe 1PL
- Container rail for 3 containers size 1PL

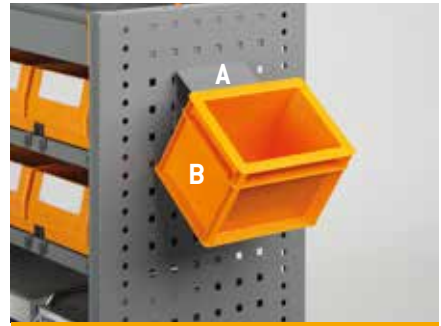

ART. NR. / ITEM NO. **BL 7432 00** A

- Behälterschiene für 1 Behälter Athena
- Container rail for 1 container Athena

ART. NR. / ITEM NO. **PM 1751 00** B

- Kunststoffbehälter gröÙe 1PL
- Polypropylene container size 1PL

ART. NR. / ITEM NO. **PM 1751 00** B

- Kunststoffbehälter gröÙe 1PL
- Polypropylene container size 1PL

ART. NR. / ITEM NO. **PA 2251 A0** B

- Kunststoffkasten aus Polypropilen serie Athena
- Polypropilene boxes series Athena





ART. NR. / ITEM NO. **FIR 000** A

- Gasflaschenhalter
- Gas cylinder kit

ART. NR. / ITEM NO. **FIR 4KG** B

- Feuerloescher (Pulver) 4 KG
- Fire extinguisher (powder) 4 KG



ART. NR. / ITEM NO. **V18029 03** A

- Horizontale Lasthalteschiene mit medium Lochung B=365 mm
- Horizontal load restraining bar with medium hole connector W=365 mm

ART. NR. / ITEM NO. **V18029 04** A

- Horizontale Lasthalteschiene mit medium Lochung B=445 mm
- Horizontal load restraining bar with medium hole connector W=445 mm

ART. NR. / ITEM NO. **V22868** B

- Zurrgurte mit Ratschenschloss mit medium Anschlussteil
- Medium connector ratchet load restraining belt

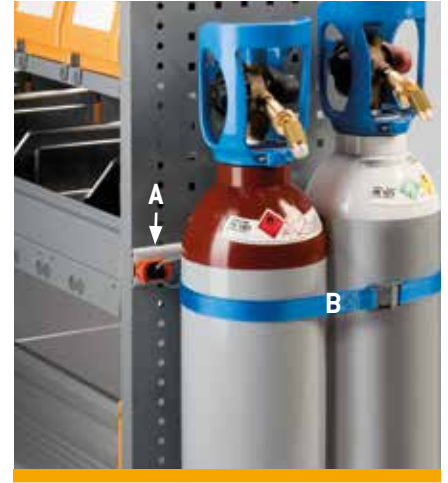

ART. NR. / ITEM NO. **V18029 03** A

- Horizontale Lasthalteschiene mit medium Lochung B=365 mm
- Horizontal load restraining bar with medium hole connector W=365 mm

ART. NR. / ITEM NO. **V18029 04** A

- Horizontale Lasthalteschiene mit medium Lochung B=445 mm
- Horizontal load restraining bar with medium hole connector W=445 mm

ART. NR. / ITEM NO. **V22869** B

- Zurrgurte mit Hebelspannschloss mit medium Anschlussteil
- Medium connector clamp load restraining belt



Beispiel mit
2 ART. NR. / ITEM NO. **FIR 000**
Example with
2 ART. NR. / ITEM NO. **FIR 000**



Beispiel mit
2 ART. NR. / ITEM NO. **V18029 03**
2 ART. NR. / ITEM NO. **V22868**
Example with
2 ART. NR. / ITEM NO. **V18029 03**
2 ART. NR. / ITEM NO. **V22868**



Beispiel mit
2 ART. NR. / ITEM NO. **V18029 03**
2 ART. NR. / ITEM NO. **V22869**
Example with
2 ART. NR. / ITEM NO. **V18029 03**
2 ART. NR. / ITEM NO. **V22869**



ART. NR. / ITEM NO. **00 ROLL SU** A

- Schienenträger-Satz für STORE BOX ROLL
- Set of supports for STORE BOX ROLL

ART. NR. / ITEM NO. **00 ROLL 00** B

- Plattform mit Rollen mit Bremsen für Koffer BOX 102-136-238-374
- Trolley with castors with brakes for tool case BOX 102-136-238-374



KASTENWAGEN - PANEL VAN
NISSAN NV400







KASTENWAGEN - PANEL VAN
NISSAN NV400

NISSAN NV400

LIEFERBEDINGUNGEN

- Bodenplatten und Seitenverkleidungen werden in mehreren Teilen geliefert.
- Dachträger und Leiterträger werden **lose** geliefert.
- Module werden **vormontiert** komplett mit Fahrzeugbefestigungsmaterial geliefert.
- Produkte sollen vorzugsweise von **Vertragshändlern** installiert werden.
- Produkte werden **verpackt** geliefert.
- **3 Jahre Garantie** auf unsere Komponenten.
- Die Tragkräfte beziehen sich auf **gleichmäßig verteilte Last**.

SUPPLY CONDITIONS

- Flooring and linings supplied in several pieces.
- Roof and ladder racks supplied **flat-packed**.
- Modules are supplied **preassembled** complete of fixing material to the vehicle.
- For products installation, please get in touch with our **approved installer's network**.
- Products provided **with packaging**.
- Our products are covered by a **3-years warranty**.
- Load capacities refer to **uniformly distributed loads**.



FAMI S.R.L.

VIA STAZIONE ROSSANO, 13 – 36027 ROSÀ (VI) ITALY
TEL +39 0424 585455 R.A. – FAX +39 0424 585482
INFO@FAMISPA.COM – WWW.FAMISPA.COM

INFO@STOREVAN.COM – WWW.STOREVAN.COM

