



ALLESTIMENTI VEICOLI COMMERCIALI
AMÉNAGEMENTS DE VÉHICULES UTILITAIRES



RENAULT KANGOO





Store Van è l'unico produttore al mondo di allestimenti per veicoli commerciali ad utilizzare questa tecnologia.

StoreVan est le seul fabricant d'aménagements de véhicules utilitaires au monde à utiliser cette technologie.

TECNOLOGIE

ACCIAIO GALVANNEALED

La lamiera galvannealed è una variante della lamiera zincata a caldo. Il prodotto subisce un processo di zincatura a caldo e un successivo riscaldamento ad una temperatura di ca. 550°C attraverso il quale lo zinco si salda alla superficie della lamiera formando una lega con l'acciaio.

Il risultato che si ottiene è uno strato zincato uniforme e dalla struttura cristallina fine abbinati ad una **qualità della superficie e una resistenza alla corrosione nettamente superiori**. Questo processo è ideale per le applicazioni automotive. Store Van ha introdotto e implementato tale tecnologia anche nel settore dell'allestimento veicoli industriali.

VERNICIATURA PER IMMERSIONE - CATODICA - CON RESINA ACRILICA

La verniciatura per cataforesi è un trattamento superficiale di verniciatura in grado di conferire agli elementi dell'allestimento una **notevole resistenza alla corrosione**; è caratterizzata dal **deposito uniforme** di una resina acrilica sulla superficie dell'elemento, assicurando per lungo tempo un'elevata protezione nei confronti degli agenti chimici e di altri tipi di attacchi. La resina acrilica consente una diretta esposizione agli agenti atmosferici mantenendo inalterate le caratteristiche tecniche. Con questo processo si assicura una maggiore protezione dalla ruggine.

- Resistenza alla corrosione superiore a 500 ore (umidità ASTM D1735)
- Eccellente durezza con valutazione minima 2H



STORE VAN ORANGE PLANET

Sostenibilità ambientale e sviluppo eco-compatibile sono temi di rilevante attualità ed interesse, sorti dalla crescente consapevolezza che si debba prestare attenzione all'equilibrio ambientale.

STORE VAN ORANGE PLANET

La durabilità ambientale e lo sviluppo eco-compatibile sono temi di rilevante attualità ed interesse, sorti dalla crescente consapevolezza che si debba prestare attenzione all'equilibrio ambientale.

TECNOLOGIES

ACIER GALVANNEALED

La tôle galvannealed est une variante de la tôle galvanisée à chaud. Le produit est soumis à un procédé de galvanisation à chaud, puis de chauffage à une température d'env. 550 °C par lequel le zinc se soude à la surface de la tôle en formant un alliage avec l'acier.

Le résultat obtenu est une couche de zinc uniforme et une structure cristalline fine combinées à **une qualité de la surface et une résistance à la corrosion nettement plus élevées**. Ce procédé est idéal pour les applications au sein du secteur automobile. StoreVan a introduit et optimisé cette technologie également dans le domaine des aménagements de véhicules utilitaires.

PEINTURE PAR IMMERSION - CATHODIQUE - AVEC RESINE ACRYLIQUE

La peinture cathodique est un traitement de surface qui permet de conférer aux éléments de l'aménagement **une résistance remarquable à la corrosion** ; elle est caractérisée par le **dépôt uniforme** d'une résine acrylique sur la surface de l'élément, en garantissant une haute et durable protection contre les agents chimiques et d'autres types d'agressions. La résine acrylique permet une exposition directe aux agents atmosphériques, tout en conservant inchangées les caractéristiques techniques. Ce procédé garantit aussi une meilleure protection contre la rouille.

- Résistance à la corrosion supérieure à 500 heures (humidité ASTM D1735)
- Excellente dureté avec une évaluation minimale 2H



FISSAGGIO FLESSIBILE FIXATION FLEXIBLE

FLESSIBILITÀ E DUREVOLEZZA DEGLI ALLESTIMENTI PER FURGONI STORE VAN

Store Van utilizza uno speciale sistema a binario per il fissaggio delle scaffalature per furgoni allo chassis del veicolo commerciale, conferendo una grande flessibilità al posizionamento dei moduli e massimizzando l'utilizzo degli spazi interni al furgone attrezzato.

Il sistema prevede l'utilizzo di staffe che scorrono all'interno del binario in tutta la sua lunghezza anziché esser rivettate direttamente ai rinforzi dello chassis, che obbligano, nella progettazione dell'allestimento furgone, a una sostanziale rigidità nella gestione degli spazi. Il binario usato da Store Van viene fissato ai montanti verticali dell'officina mobile con la doppia funzione di collegare in maniera uniforme gli scaffali per furgoni al telaio del veicolo e di distribuire omogeneamente tutte le forze dinamiche a cui l'allestimento viene sottoposto durante la guida.

Le staffe di fissaggio che collegano il binario al modulo presentano uno speciale snodo che ammortizza le vibrazioni derivanti dalla guida del veicolo, adattandosi ai movimenti torsionali dello chassis, specialmente in percorrenza di curve.

Grazie a questo sistema, i nostri allestimenti per furgoni possono essere progettati con la massima libertà, garantendo comunque alti standard di sicurezza, stabilità e durevolezza nel tempo.

Tutti i nostri sistemi di fissaggio si possono avvalere di sistemi di aggancio/sgancio rapido dei moduli tramite maniglie a ripresa che permettono di smontare l'allestimento senza l'ausilio di utensili. In questo modo la scaffalatura della tua officina mobile può essere dichiarata come materiale trasportato o come ausilio alla sicurezza del carico non permanentemente fissato al veicolo, come descritto nella DIRETTIVA 2014/47 UE, CAPO 1, Articolo 3, paragrafo 5.

FLEXIBILITÉ ET DURÉE DES AMÉNAGEMENTS POUR FOURGONS STORE VAN

Store Van utilise un système à rail spécial pour la fixation des rayonnages pour fourgons au châssis du véhicule utilitaire : cela garantit une grande flexibilité pour le positionnement des modules et optimise l'utilisation des espaces à l'intérieur du fourgon aménagé.

Le système prévoit l'utilisation d'étriers qui coulissent à l'intérieur du rail sur toute sa longueur au lieu d'être rivetés directement aux renforts du châssis, ce qui impose, dans la conception de l'aménagement du fourgon, une grande rigueur dans la gestion des espaces. Le rail utilisé par Store Van, fixé aux montants verticaux de l'atelier mobile, a une double fonction : solidariser de manière uniforme les rayonnages pour fourgons au châssis du véhicule et distribuer de manière homogène toutes les forces dynamiques auxquelles l'aménagement est soumis durant les déplacements.

Les étriers de fixation qui relient le rail au module présentent un dispositif articulé spécial qui amortit les vibrations causées par le déplacement du véhicule, en s'adaptant aux mouvements de torsion du châssis, en particulier dans les virages.

Grâce à ce système, nos aménagements pour fourgons peuvent être conçus avec la plus grande liberté, mais dans le respect de standards de sécurité, de stabilité et de durée élevés.

Tous nos systèmes de fixation peuvent bénéficier de systèmes d'accrochage/déaccrochage rapide des modules au moyen de poignées de serrage à cliquet qui permettent de démonter l'aménagement sans utiliser d'outils. Le rayonnage de votre atelier mobile peut ainsi être déclaré comme matériel transporté ou comme dispositif de sécurité du chargement fixé au véhicule de manière non permanente, conformément aux dispositions de la directive 2014/47 UE, chapitre 1, article 3, paragraphe 5.



CERTIFICAZIONI CERTIFICATIONS

PRODUZIONE CERTIFICATA

- Certificati ISO 9001:2015.
- Superata brillantemente la prova di CRASH TEST eseguita secondo le ultime normative europee ECE-R17 con impatto a 50 Km/h.
- Certificazione GS per l'arredo interno e le rampe di carico.
- Certificazione GS per il portatutto-portascale.

PRODUCTION CERTIFIÉE

- Certifiés ISO 9001:2015.
- ESSAI DE CHOC réalisé selon les normes européennes ECE-R17 les plus récentes avec impact à 50 km/h, passé brillamment.
- Certification GS pour l'aménagement interne et les rampes de chargement.
- Certification GS pour les galeries de toit et porte-échelles.

CRASH TEST
ECE-R17



La base per la protezione sicura dei veicoli

La base pour la protection des véhicules en toute sécurité

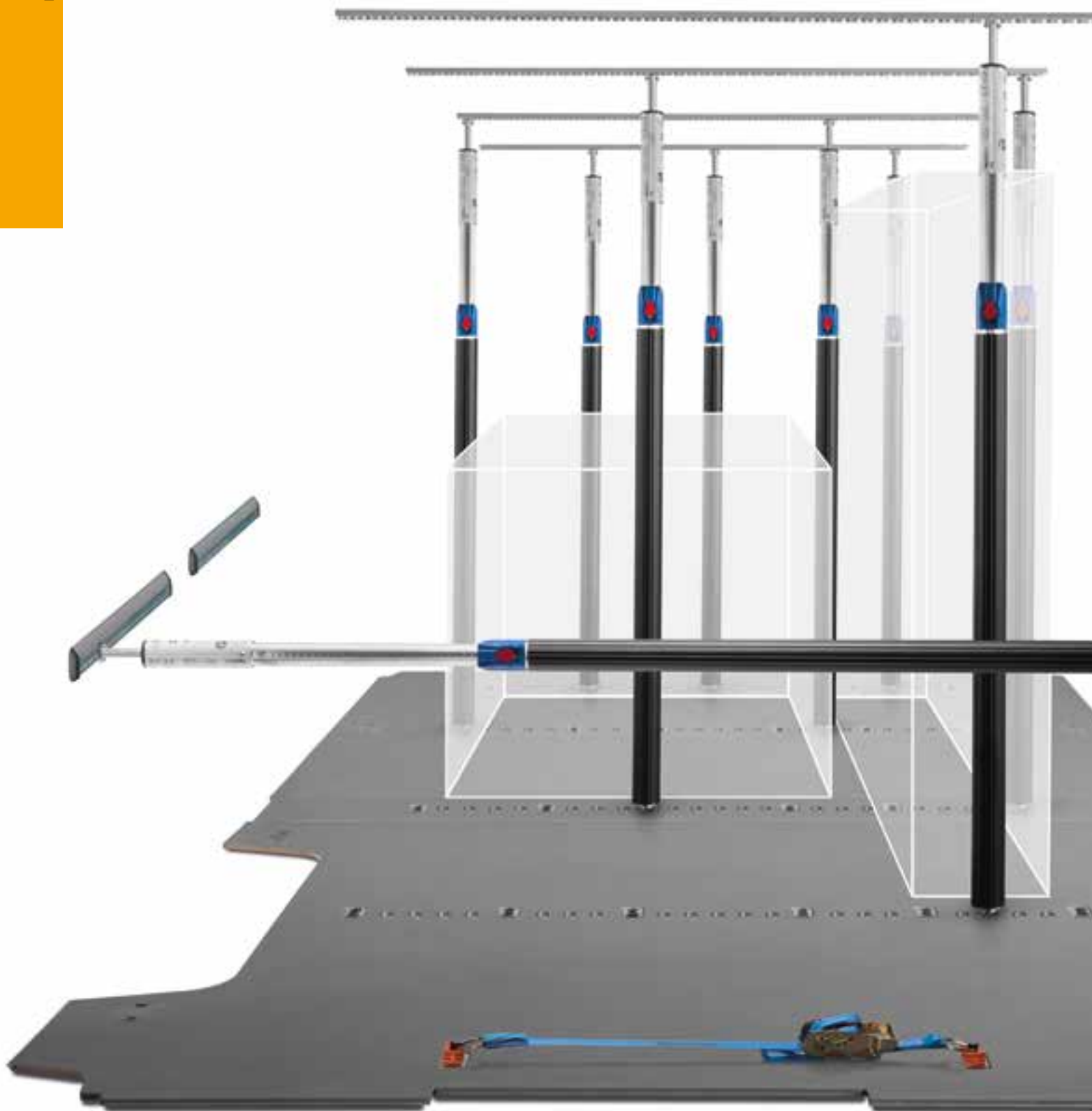

SICUREZZA DEL CARICO PER FURGONI E BLOCCAGGIO MERCE

Con il recepimento della direttiva 2014/47/EU verranno intensificati i controlli sui veicoli trasporto merci N2 e N3 e sensibilizzato il controllo del fissaggio del carico. La Direttiva consente agli Stati membri la possibilità di sottoporre a controlli tecnici veicoli che esulano dal suo ambito d'applicazione, come i veicoli commerciali della categoria N 1 e di controllare altri aspetti del trasporto e della sicurezza stradale.

SISTEMA DI PROTEZIONE DEL VANO DI CARICO E FISSAGGIO DEL CARICO

Il nuovo sistema di protezione integrato per furgoni ideato da Store Van segue le linee guida della nuova direttiva 2014/47/EU e consente il **fissaggio flessibile e sicuro** del carico ai pianali e alle pareti del veicolo.

Con l'impiego dei componenti di aggancio "Airline", e l'integrazione di numerosi accessori come cinghie, reti e pali telescopici, l'utilizzatore del veicolo può configurare la sua piattaforma di aggancio semplice, economica e a norma con la direttiva europea.

Il sistema prevede l'utilizzo di:

- pianali per furgoni in multistrato resina fenolica con predisposizione per gli ancoraggi originali del veicolo e ancoraggi supplementari (pag. 10) a filo pianale con trazione pari a 200 daN;
- barre in alluminio "Airline" ancorate allo châssis (pag. 11);
- pannellature in polipropilene ad alta flessibilità e resistenza per proteggere internamente la carrozzeria dagli urti accidentali (pag.8).

CON L'APPLICAZIONE DEL NUOVO KIT DI PROTEZIONE, SI PUÒ APPREZZARE UNA LUNGA SERIE DI VANTAGGI:

- l'utilizzatore del veicolo può già fissare il carico in sicurezza alle barre "Airline" tramite le cinghie di trattenuta.
- Il kit di fissaggio integrato prolunga la conservazione del buono stato della carrozzeria.
- Il sistema di protezione conferisce un valore aggiunto, qualità molto importante per il mercato del nuovo e fondamentale per quello dell'usato, solitamente compromesso da danneggiamenti.

SÉCURITÉ DU CHARGEMENT POUR LES FOURGONS ET BLOCAGE DE LA MARCHANDISE

Suite à la transposition de la directive 2014/47/EU, les contrôles sur les véhicules de transport de marchandises N2 et N3 s'intensifieront et le contrôle de la fixation du chargement fera l'objet d'une attention accrue. La directive offre aux États membres la possibilité de soumettre à des contrôles techniques les véhicules qui échappent à son champ d'application, comme les véhicules utilitaires de la catégorie N 1, et de contrôler d'autres aspects du transport et de la sécurité routière.

SYSTÈME DE PROTECTION DE L'ESPACE DE CHARGEMENT ET DE FIXATION DU CHARGEMENT

Le nouveau système de protection intégré pour fourgons conçu par Store Van respecte les lignes directrices de la nouvelle directive 2014/47/EU et garantit une **fixation flexible et sûre** du chargement aux planchers et aux parois du véhicule.

En utilisant les composants d'accrochage « Airline » et grâce à l'adoption de nombreux accessoires tels que des sangles, des filets et des barres télescopiques, l'utilisateur du véhicule peut aménager sa plateforme d'accrochage de manière simple, économique et conforme à la directive européenne.

Le système prévoit l'utilisation:

- de planchers pour fourgons en multiplis avec résine phénolique prééquipés pour les arrimages d'origine du véhicule et les arrimages supplémentaires (page 10) au ras du plancher avec une traction de 200 daN ;
- de barres en aluminium « Airline » fixées au châssis (page 11) ;
- de panneaux en polypropylène très flexibles et résistants pour protéger l'intérieur de la carrosserie contre les chocs accidentels (page 8).

L'APPLICATION DU NOUVEAU KIT DE PROTECTION GARANTIT TOUTE UNE SÉRIE D'AVANTAGES:

- l'utilisateur du véhicule peut déjà fixer, de manière sûre, le chargement aux barres « Airline », grâce aux sangles d'arrimage;
- le kit de fixation intégré permet de conserver la carrosserie en bon état plus longtemps ;
- le système de protection confère au véhicule de la valeur ajoutée, une qualité très importante sur le marché du neuf et fondamentale pour celui de l'occasion, généralement mis à mal par les fréquents dommages.

SAFETY CROSS: punti di fissaggio longitudinali e trasversali su richiesta
SAFETY CROSS: points de fixation longitudinaux et transversaux sur demande

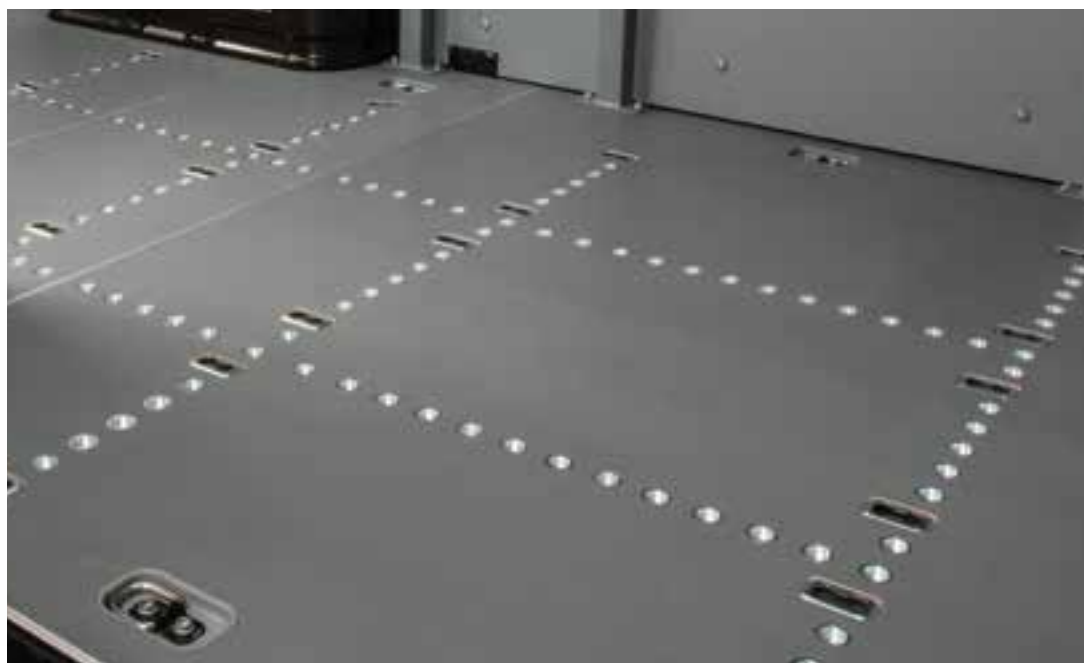



- Pannellatura per veicolo con porta laterale destra e pareti lamierate.
- Habillages pour véhicule avec porte latérale droite et parois en tôle.



HONEYCOMB PANEL - A

- Pannellatura in polipropilene per:
 - parete laterale sinistra
 - parete laterale destra e porta scorrevole
- Habillage en polypropylène pour:
 - paroi latérale gauche
 - paroi latérale droite et porte coulissante

HONEYCOMB PANEL - C

- Pannellatura in polipropilene per:
 - parte superiore delle porte posteriori a battente
- Habillage en polypropylène pour :
 - partie supérieure des portes arrière battantes

VEICOLO VÉHICULE	PANNELLATURA HABILLAGE	
	A ART.	C ART.
Modello - Modèle L0 H1 Compact ^A	KA 00H1 DO 3,38 kg	KA DRH1 AO 0,86 kg
Modello - Modèle L0 H1 Compact ^B	KA 00H1 DO 3,38 kg	KA DRH1 AO 0,86 kg
Modello - Modèle L1 H1 ^A	KA 10H1 AO 3,47 kg	KA DRH1 AO 0,86 kg
Modello - Modèle L1 H1 ^B	KA 10H1 AO 3,47 kg	KA DRH1 AO 0,86 kg
Modello - Modèle L2 H1 Maxi ^A	KA 20H1 AO 4,48 kg	KA DRH1 AO 0,86 kg
Modello - Modèle L2 H1 Maxi ^B	KA 20H1 AO 4,48 kg	KA DRH1 AO 0,86 kg



^A Paratia in lamiera - Panneau de séparation tôle

^B Paratia in rete con cancelletto - Panneau de séparation grillagé avec portillon





- Pianale per veicolo con porta laterale destra e pareti lamierate.
- Plancher pour véhicule avec porte latérale droite et parois en tôle.



WOOD FLOOR - D

- Pianale in legno spessore 9 mm con rivestimento fenolico e predisposizione per gli ancoraggi originali del veicolo
- Plancher en bois de 9 mm avec revêtement phénolique et équipé pour les ancrages originaux du véhicule

VEICOLO VÉHICULE	PIANALE 9 mm PLANCHER 9 mm
	D
	ART.
Modello - Modèle L0 ^A	KA 00D1 DO 9,74 kg
Modello - Modèle L0 ^B	KA 00D2 DO 9,29 kg
Modello - Modèle L1 ^A	KA 10D1 BO 13,10 kg
Modello - Modèle L1 ^B	KA 10D2 BO 12,65 kg
Modello - Modèle L2 ^A	KA 20D1 BO 16,82 kg
Modello - Modèle L2 ^B	KA 20D2 BO 16,38 kg



^A Paratia in lamiera - Panneau de séparation tôle

^B Paratia in rete con cancelletto - Panneau de séparation grillagé avec portillon



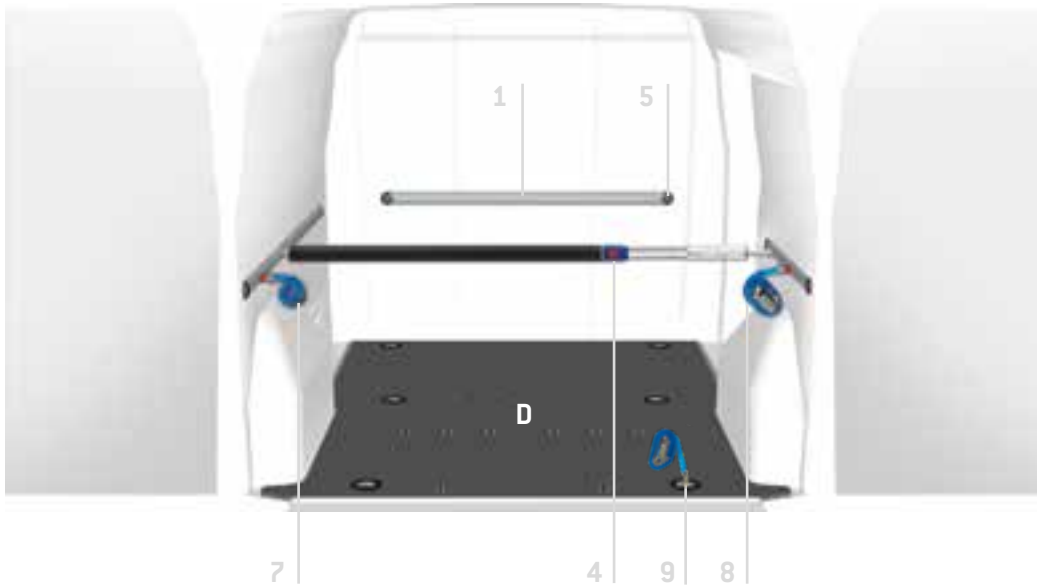

- Pianale per veicolo con porta laterale destra e pareti lamierate.
- Plancher pour véhicule avec porte latérale droite et parois en tôle.

VEICOLO
VÉHICULEPIANALE 9 mm
PLANCHER 9 mm

D

ART.

Modello - Modèle
L1^AKA 10K1 B0
14,92 kgModello - Modèle
L2^AKA 20K1 B0
19,25 kg^A Paratia in lamiera - Panneau de séparation tôleIl pianale deve essere incollato al veicolo
Le plancher doit être collé au véhicule

- Colla siliconica per pianali.
- Colle en silicone pour planchers.

ART.

V22585



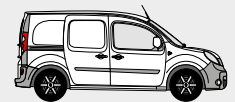

- Barra orizzontale in alluminio.
- Barre horizontale en aluminium.

1

ART.

V18029 05	Lunghezza - Longueur 500 mm
V18029 10	Lunghezza - Longueur 1000 mm
V18029 15	Lunghezza - Longueur 1500 mm
V18029 20	Lunghezza - Longueur 2000 mm
V18029 25	Lunghezza - Longueur 2500 mm



- Barra orizzontale in alluminio.
- Barre horizontale en aluminium.

2

ART.

V18025 05	Lunghezza - Longueur 500 mm
V18025 10	Lunghezza - Longueur 1000 mm
V18025 15	Lunghezza - Longueur 1500 mm
V18025 20	Lunghezza - Longueur 2000 mm



- Barra orizzontale in alluminio.
- Barre horizontale en aluminium.

3

ART.

V18030 10	Lunghezza - Longueur 1000 mm
V18030 15	Lunghezza - Longueur 1500 mm
V18030 20	Lunghezza - Longueur 2000 mm
V18030 25	Lunghezza - Longueur 2500 mm
V18030 30	Lunghezza - Longueur 3000 mm



- Barra telescopica fermacarico.
- Barre télescopique d'arrimage.

4

ART.

V22149	Lunghezza - Longueur 650-900 mm
V22734	Lunghezza - Longueur 850-1100 mm
V22735	Lunghezza - Longueur 1050-1300 mm
V22131	Lunghezza - Longueur 1250-1750 mm
V22017	Lunghezza - Longueur 1550-2050 mm
V22086	Lunghezza - Longueur 2000-2500 mm



- Finale in plastica per barra serie V18029.
- Bouchon en plastique pour barre série V18029.

5

ART.

V22106



- Anello fermacarico.
- Anneau d'arrimage.

6

ART.

V225820



- Cinghia fermacarico con morsetto 2500+500.
- Sangle d'arrimage avec crochet 2500+500.

7

ART.

V22136



- Cinghia fermacarico con cricchetto 2280+420.
- Sangle d'arrimage à cliquet 2280+420.

8

ART.

V22124



- Cinghia fermacarico con cricchetto 4500+500.
- Sangle d'arrimage à cliquet 4500+500.

9

ART.

V22148



- Esempio valigetta per il fissaggio del carico.
- Exemple de mallette pour sécurisation du chargement.



4 ART.
V225820



1 ART.
BOX080

L=440 P=350 H=80 mm



1 ART.
CPV080



1 ART.
YELLOW



2 ART.
V22136



2 ART.
V22124



2 ART.
V22148

Per maggiori informazioni richiedi il catalogo
"Sicurezza del carico"

Pour plus d'informations, demandez le catalogue
"Sécurisation du chargement"



LEGENDA PANNELLATURE - LÉGENDE HABILLAGES

RENAULT KANGOO

FURGONE LAMIERATO - FOURGON TÔLÉ

HONEYCOMB
PANEL

HP

- Per veicolo con porta laterale destra e pareti lamierate.
- Pour véhicule avec porte latérale droite et parois en tôle.

Modello - Modèle
L0 H1

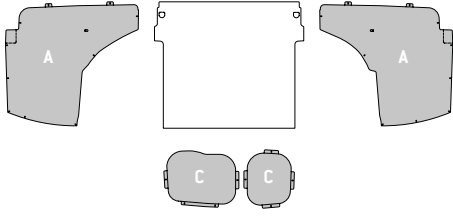

Modello - Modèle
L1 H1

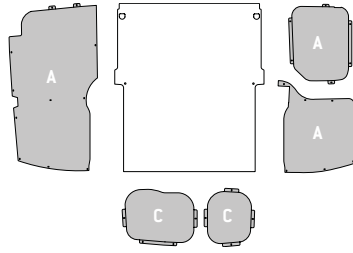

Modello - Modèle
L2 H1

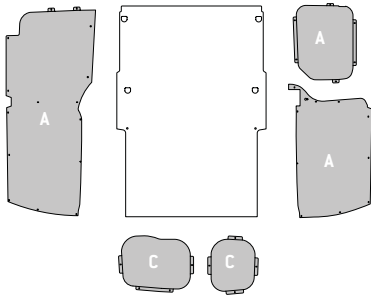

SAFETY CROSS: punti di fissaggio longitudinali e trasversali su richiesta
 SAFETY CROSS: points de fixation longitudinaux et transversaux sur demande

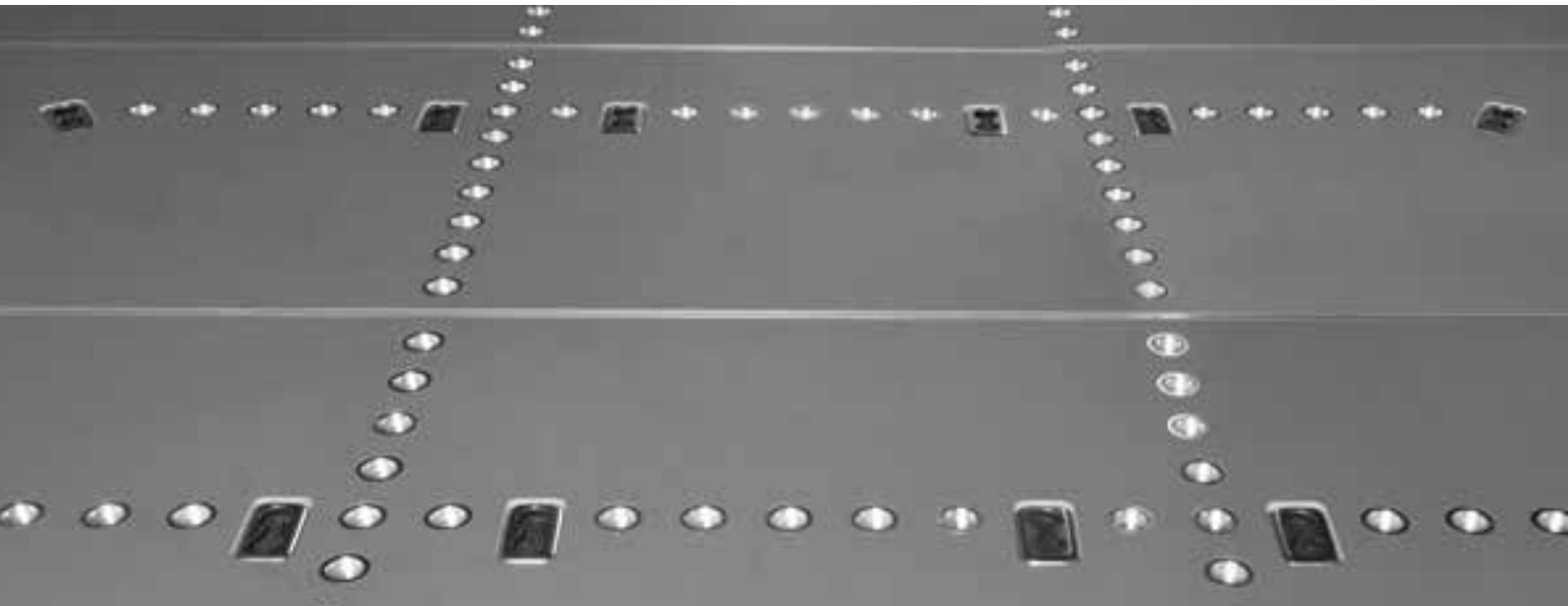



- Per veicolo con porta laterale destra e pareti lamierate.
- Pour véhicule avec porte latérale droite et parois en tôle.

Modello - Modèle L0 ^A	Modello - Modèle L0 ^B	Modello - Modèle L1 ^A	Modello - Modèle L1 ^B	Modello - Modèle L2 ^A	Modello - Modèle L2 ^B

^A Paratia in lamiera - Panneau de séparation tôle

^B Paratia in rete con cancelletto - Panneau de séparation grillagé avec portillon

- Per veicolo con porta laterale destra e pareti lamierate.
- Pour véhicule avec porte latérale droite et parois en tôle.

Modello - Modèle L1 ^A	Modello - Modèle L2 ^A



• Per ogni pianale, ogni fila di fissaggi è composta da 4/6 punti di ancoraggio "Airline".

• Sur chaque plancher, chaque rangée d'arrimages se compose de 4/6 points d'ancrage "Airline".

^A Paratia in lamiera - Panneau de séparation tôle



**Il fissaggio del carico
è di serie**

La fixation du
chargement de série





La soluzione d'**allestimento per furgoni SAFETY** di Store Van nasce per soddisfare i requisiti delle nuove disposizioni sulla sicurezza del carico. Nei moduli vengono integrati elementi strutturali che permettono l'utilizzo di sistemi di trattenuta "Airline", quali cinghie, reti e pali telescopici. Questo nuovo livello di **allestimento per veicoli commerciali** facilita l'ancoraggio di oggetti medio piccoli anche in presenza di pianali per furgoni privi di sistemi di ancoraggio, garantendo così la sicurezza del carico. Gli elementi di ancoraggio "Airline" del livello SAFETY aumentano la stabilità del modulo senza maggiorarne il peso in quanto integrati nella struttura stessa dell'allestimento.

La solution d'**aménagement pour fourgons SAFETY** de Store Van a été conçue pour répondre aux exigences des nouvelles dispositions en matière de sécurité du chargement. Dans les modules, les éléments structurels intégrés permettent d'utiliser des systèmes de maintien « Airline », tels que des sangles, des filets et des barres télescopiques. Ce nouveau niveau d'**aménagement pour véhicules utilitaires** facilite l'arrimage d'objets moyens et petits, même en cas de planchers pour fourgons sans systèmes d'arrimage, ce qui garantit la sécurité du chargement. Les éléments d'arrimage « Airline » du niveau SAFETY améliorent la stabilité du module sans augmenter son poids car ils sont intégrés dans la structure même de l'aménagement.





L1 H1

RENAULT KANGOO
FURGONE LAMIERATO - FOURGON TÔLÉ

SAFETY

ESEMPI DI ALLESTIMENTO - EXEMPLES D'AMÉNAGEMENTS



ESEMPIO - EXEMPLE

KA 1210 01*

L=1225 P=365 H=1050 mm

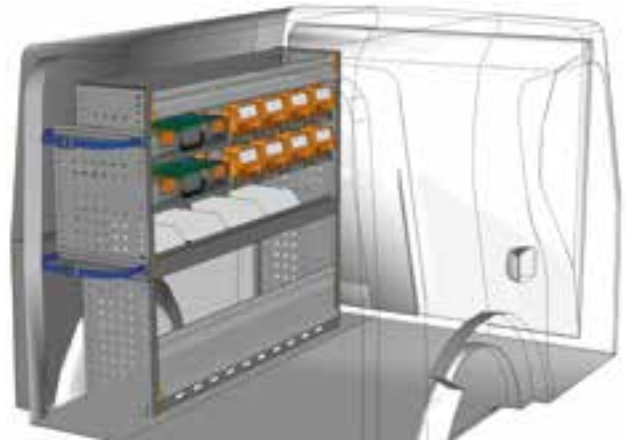
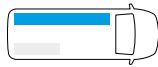

ESEMPIO - EXEMPLE

KA 1210 02*

L=1225 P=365 H=1050 mm

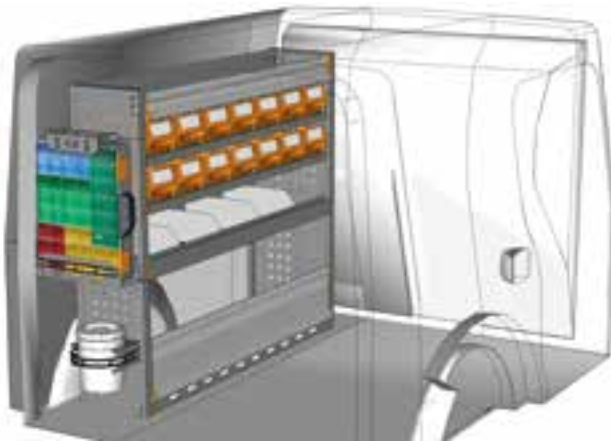

ESEMPIO - EXEMPLE

KA 1210 03*

L=1225 P=365 H=1050 mm

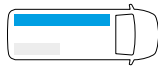

ESEMPIO - EXEMPLE

KA 1210 05*

L=1225 P=365 H=1000 mm

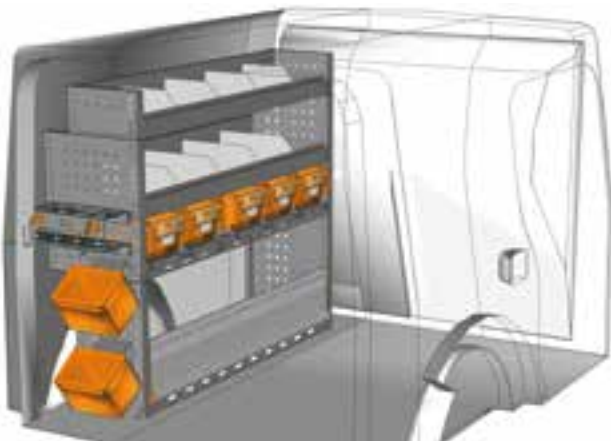

ESEMPIO - EXEMPLE

KA 1210 06*

L=1225 P=365 H=1050 mm

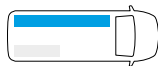

ESEMPIO - EXEMPLE

KA 1210 09*

L=1225 P=365 H=1050 mm

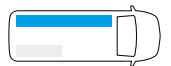

* Kit fissaggio incluso - Jeu de fixation inclus

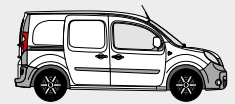

ESEMPI DI ALLESTIMENTO - EXEMPLES D'AMÉNAGEMENTS

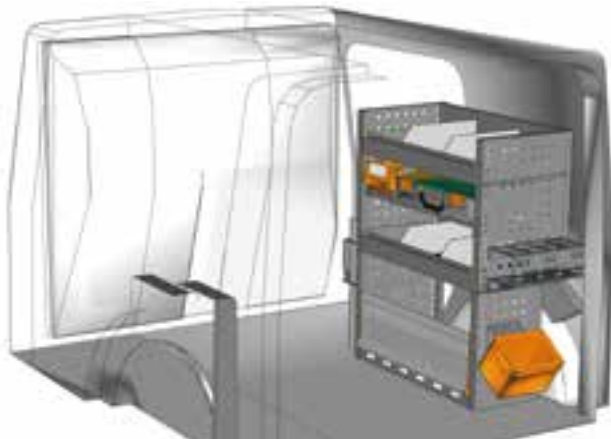

ESEMPIO - EXEMPLE

KA 0709 01*

L=717 P=365 H=900 mm

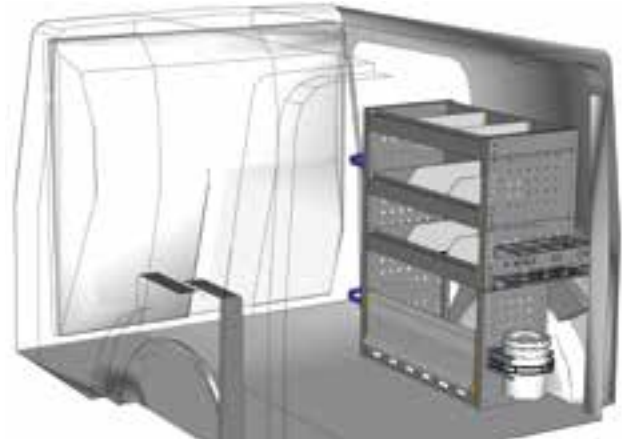
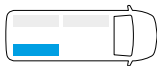

ESEMPIO - EXEMPLE

KA 0709 02*

L=717 P=365 H=900 mm

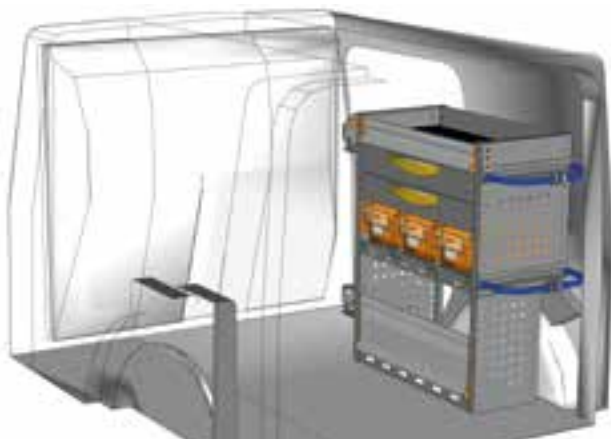
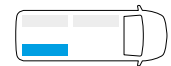

ESEMPIO - EXEMPLE

KA 0709 03*

L=717 P=365 H=900 mm

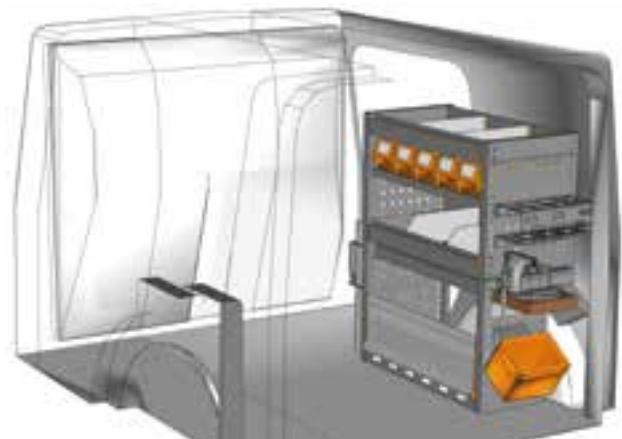
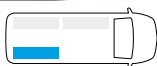

ESEMPIO - EXEMPLE

KA 0709 09*

L=717 P=365 H=900 mm

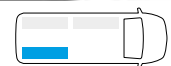

ESEMPIO - EXEMPLE

KA 0709 10*

L=717 P=365 H=900 mm



Non hai trovato il tuo allestimento?

Affidati ai nostri professionisti

Guarda il retro di questo catalogo e
contatta il punto Store Van più vicino
oppure visita il nostro sito.

**Vous n'avez pas trouvé votre
équipement ? Confiez-vous
à nos professionnels**

Voir au dos de ce catalogue
et contactez le point StoreVan
le plus proche ou visitez notre site web.



* Kit fissaggio incluso - Jeu de fixation inclus

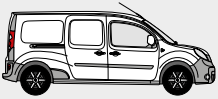

L2 H1

RENAULT KANGOO
FURGONE LAMIERATO - FOURGON TÔLÉ

SAFETY

ESEMPI DI ALLESTIMENTO - EXEMPLES D'AMÉNAGEMENTS

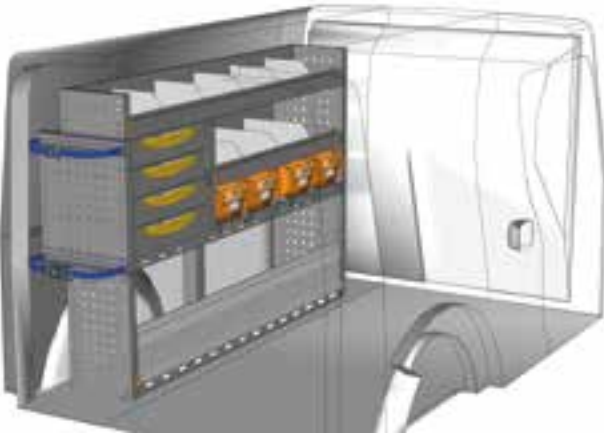

ESEMPIO - EXEMPLE

KA 1510 01*

L=1524 P=365 H=1050 mm

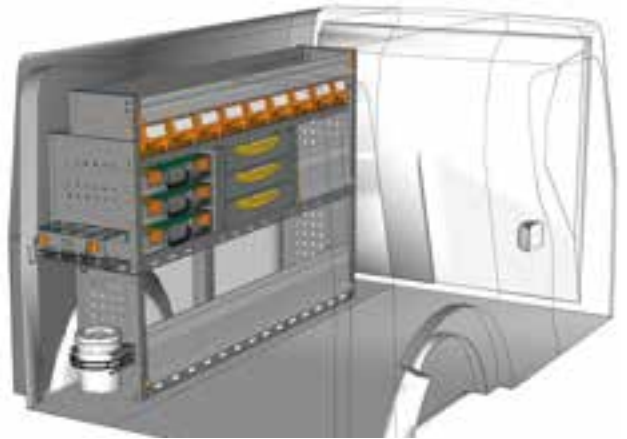
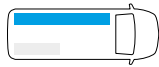

ESEMPIO - EXEMPLE

KA 1510 02*

L=1524 P=365 H=1050 mm

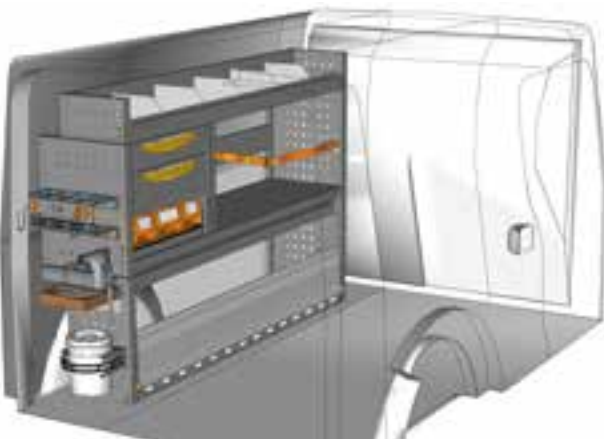

ESEMPIO - EXEMPLE

KA 1510 03*

L=1524 P=365 H=1050 mm

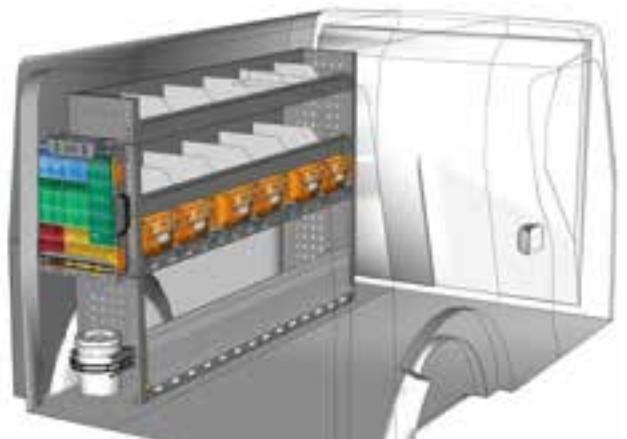
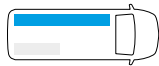

ESEMPIO - EXEMPLE

KA 1510 04*

L=1524 P=365 H=1050 mm

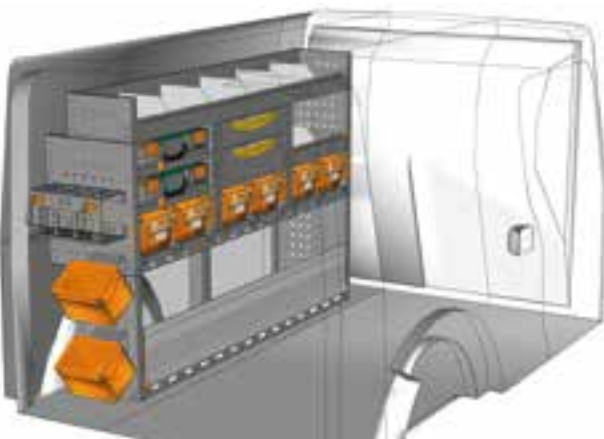

ESEMPIO - EXEMPLE

KA 1510 05*

L=1524 P=365 H=1050 mm

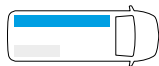

ESEMPIO - EXEMPLE

KA 1510 06*

L=1524 P=365 H=1000 mm

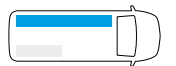

* Kit fissaggio incluso - Jeu de fixation inclus

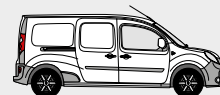

ESEMPI DI ALLESTIMENTO - EXEMPLES D'AMÉNAGEMENTS



ESEMPIO - EXEMPLE

KA 1009 01*

L=1016 P=365 H=900 mm

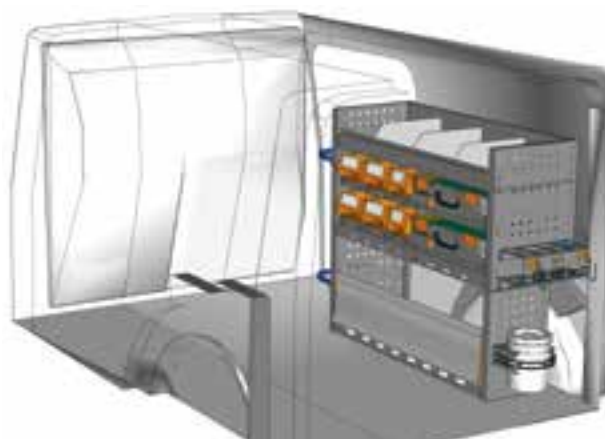
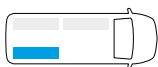

ESEMPIO - EXEMPLE

KA 1009 02*

L=1016 P=365 H=900 mm

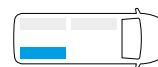

Vista da porta laterale
Vue de porte latérale



ESEMPIO - EXEMPLE

KA 1009 03*

L=1016 P=365 H=900 mm

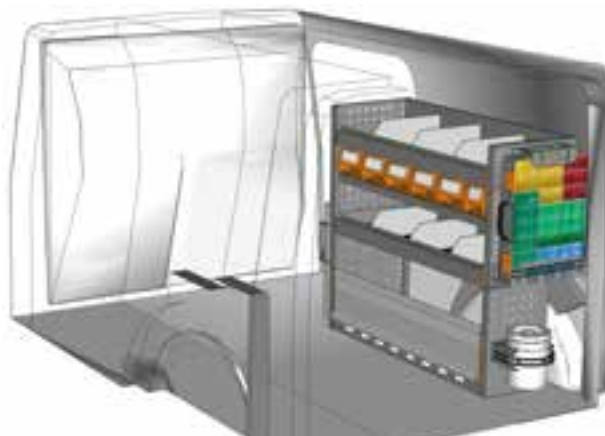
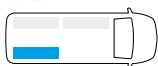

ESEMPIO - EXEMPLE

KA 1009 04*

L=1016 P=365 H=900 mm

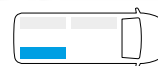

ESEMPIO - EXEMPLE

KA 1009 05*

L=1016 P=365 H=900 mm

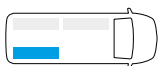

Non hai trovato il tuo allestimento?
Affidati ai nostri professionisti
Guarda il retro di questo catalogo e
contatta il punto Store Van piu vicino
oppure visita il nostro sito.

**Vous n'avez pas trouvé votre
équipement ? Confiez-vous
à nos professionnels**
Voir au dos de ce catalogue
et contactez le point StoreVan
le plus proche ou visitez notre site web.



* Kit fissaggio incluso - Jeu de fixation inclus



**L'integrazione perfetta
tra veicolo e allestimento
officina mobile**

**L'intégration parfaite
entre le véhicule et
l'aménagement de l'atelier
mobile**





L'allestimento per furgoni PROFESSIONAL progettato da Store Van è integrato perfettamente nel veicolo ed è studiato appositamente per esaltarne le caratteristiche strutturali e dinamiche. I moduli di questo nuovo livello di **allestimento per veicolo commerciale**, come le scaffalature per furgoni, integrano, di serie, elementi per un perfetto fissaggio del carico al telaio del veicolo mediante l'utilizzo dei sistemi di trattenuta "Airline". Sono disponibili sistemi di trattenuta del carico verticali e orizzontali grazie al nuovo pianale SAFETY FLOOR.

L'aménagement pour fourgons PROFESSIONAL conçu par Store Van est parfaitement intégré au véhicule et a été spécialement étudié pour en optimiser les caractéristiques structurales et dynamiques. Les modules de ce nouveau niveau d'**aménagement pour véhicule utilitaire**, comme les rayonnages pour fourgons, comprennent, de série, des éléments conçus pour une fixation parfaite du chargement au châssis du véhicule grâce à l'utilisation des systèmes de maintien « Airline ». Des systèmes de maintien du chargement verticaux et horizontaux sont disponibles grâce au nouveau plancher SAFETY FLOOR.

FURGONE LAMIERATO - FOURGON TÔLE
RENAULT KANGOO

PROFESSIONAL





L1 H1

RENAULT KANGOO
FURGONE LAMIERATO - FOURGON TÔLÉ

PROFESSIONAL

ESEMPI DI ALLESTIMENTO - EXEMPLES D'AMÉNAGEMENTS



ESEMPIO - EXEMPLE

KA 1211 P1*

L=1225 P=365 H=1050 mm

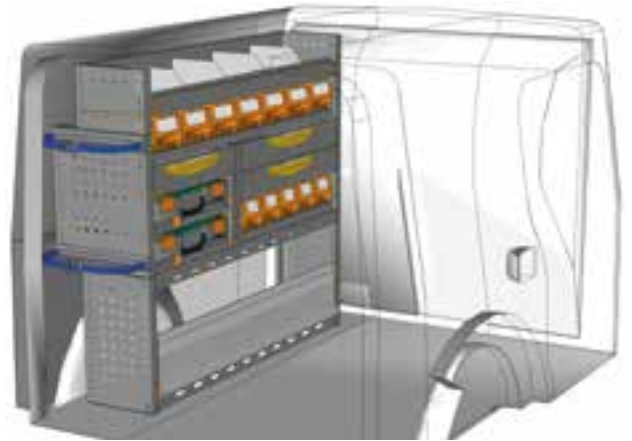
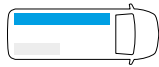

ESEMPIO - EXEMPLE

KA 1211 P2*

L=1225 P=365 H=1100 mm



ESEMPIO - EXEMPLE

KA 1211 P3*

L=1225 P=365 H=1050 mm

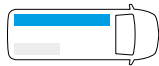

ESEMPIO - EXEMPLE

KA 0711 P1*

L=717 P=365 H=1050 mm



ESEMPIO - EXEMPLE

KA 0711 P2*

L=717 P=365 H=1100 mm

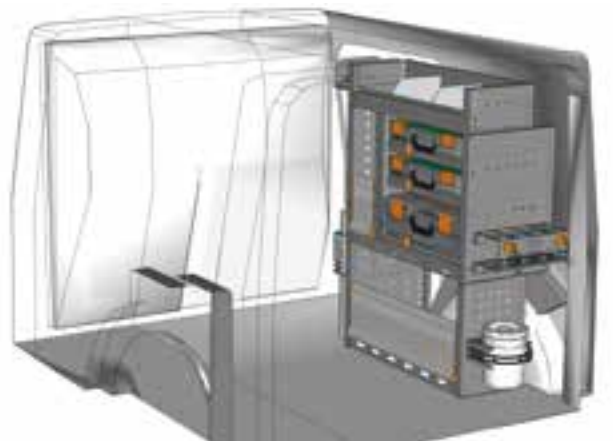
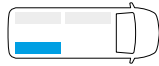

ESEMPIO - EXEMPLE

KA 0711 P3*

L=717 P=365 H=1050 mm



* Kit fissaggio incluso - Jeu de fixation inclus



ESEMPI DI ALLESTIMENTO - EXEMPLES D'AMÉNAGEMENTS

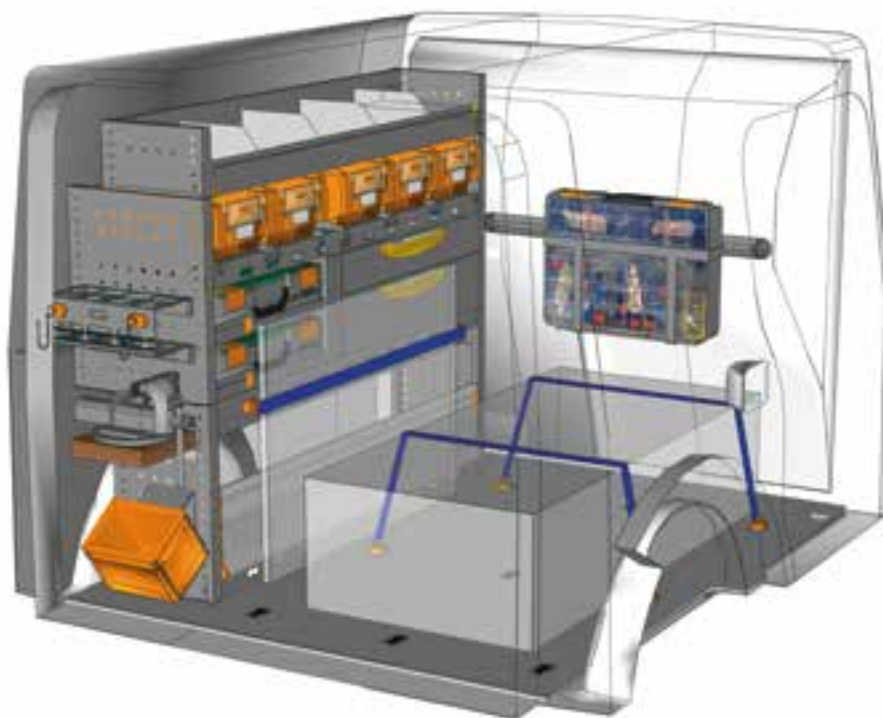

ESEMPIO - EXEMPLE

EXAMPLE KA L1H1 P1*



- | | |
|----------------|-------------|
| 1 x KA 1211 P2 | 2 x V22124 |
| 1 x KA 10K1 B0 | 2 x V22148 |
| 1 x V22585 | 1 x YELLOW |
| 1 x V18029 10 | 4 x V225820 |
| 2 x V22106 | |
| 1 x BOX080 | |
| 1 x CPV080 | |
| 2 x V22136 | |



ESEMPIO - EXEMPLE

EXAMPLE KA L1H1 P2*



- | | |
|----------------|-------------|
| 1 x KA 0711 P2 | 2 x V22124 |
| 1 x KA 10K1 B0 | 2 x V22148 |
| 1 x V22585 | 1 x YELLOW |
| 1 x V18029 10 | 4 x V225820 |
| 2 x V22106 | |
| 1 x BOX080 | |
| 1 x CPV080 | |
| 2 x V22136 | |

Non hai trovato il tuo allestimento?

Affidati ai nostri professionisti

Guarda il retro di questo catalogo e
contatta il punto Store Van piu vicino
oppure visita il nostro sito.

**Vous n'avez pas trouvé votre
équipement ? Confiez-vous
à nos professionnels**

Voir au dos de ce catalogue
et contactez le point StoreVan
le plus proche ou visitez notre site web.

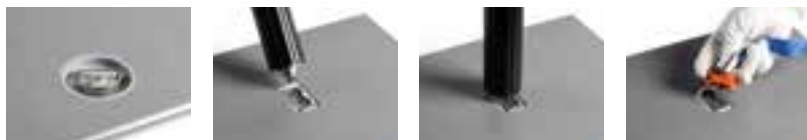

vedi pag. 10/11
voir page 10/11

* Kit fissaggio incluso - Jeu de fixation inclus

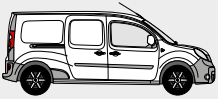

L2 H1

ESEMPIO DI ALLESTIMENTO - EXEMPLES D'AMÉNAGEMENTS

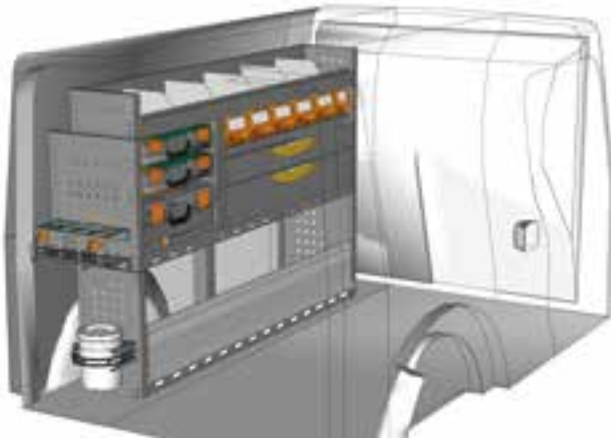

ESEMPIO - EXEMPLE

KA 1511 P1*

L=1524 P=365 H=1050 mm

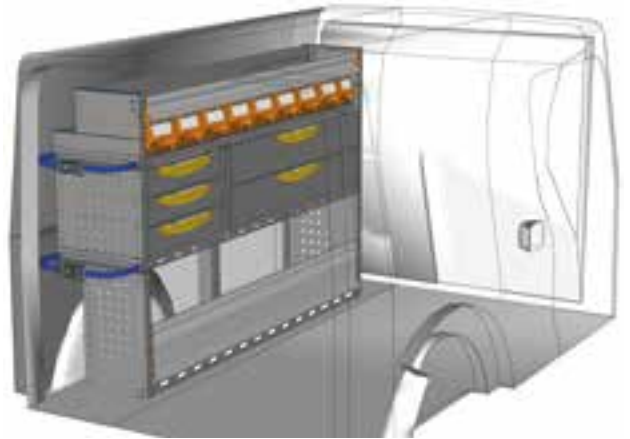
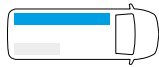

ESEMPIO - EXEMPLE

KA 1511 P2*

L=1524 P=365 H=1050 mm

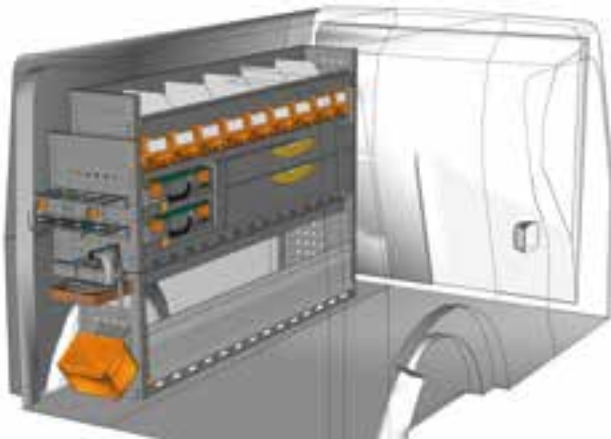

ESEMPIO - EXEMPLE

KA 1511 P3*

L=1524 P=365 H=1050 mm

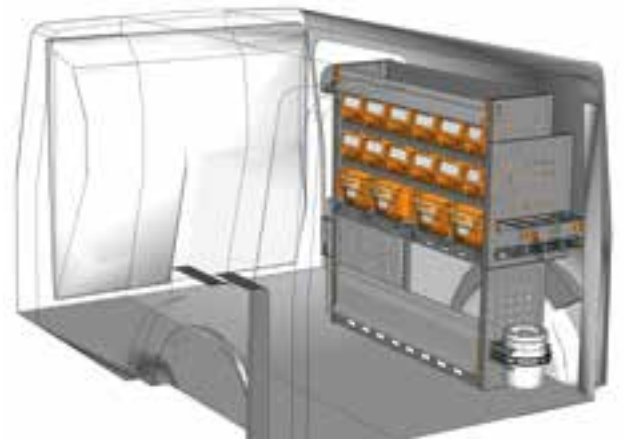
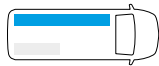

ESEMPIO - EXEMPLE

KA 1011 P1*

L=1016 P=365 H=1050 mm

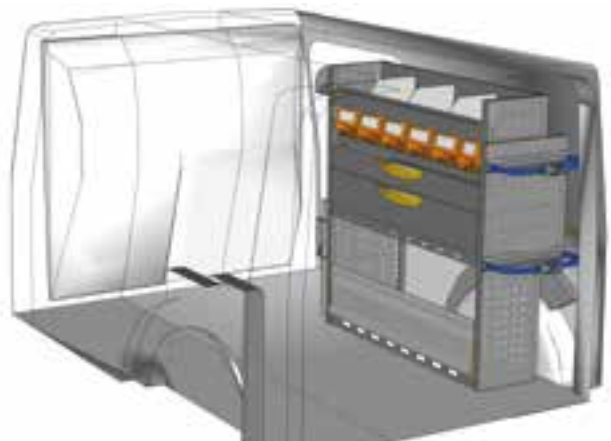

ESEMPIO - EXEMPLE

KA 1011 P2*

L=1016 P=365 H=1050 mm

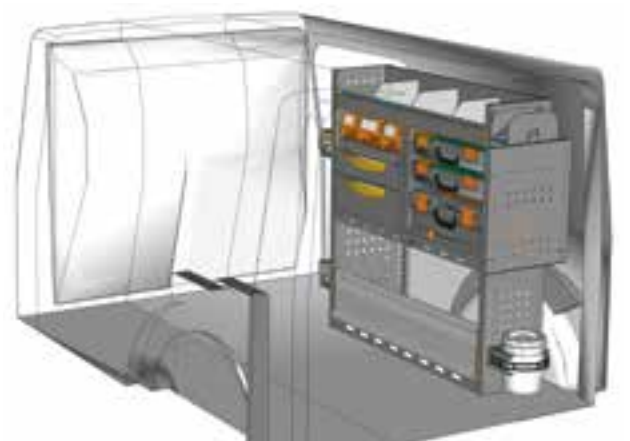
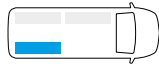

ESEMPIO - EXEMPLE

KA 1011 P3*

L=1016 P=365 H=1050 mm

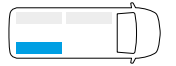

* Kit fissaggio incluso - Jeu de fixation inclus

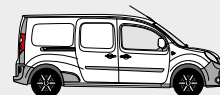

ESEMPI DI ALLESTIMENTO - EXEMPLES D'AMÉNAGEMENTS

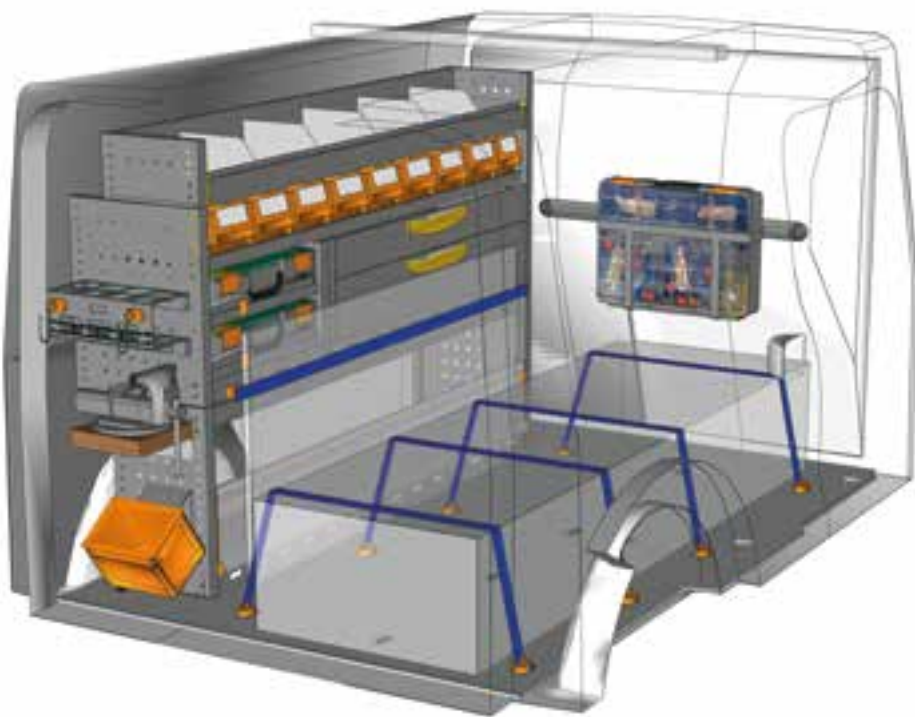

ESEMPIO - EXEMPLE

EXAMPLE KA L2H1 P1*



- | | |
|----------------|-------------|
| 1 x KA 1511 P3 | 2 x V22124 |
| 1 x KA 20K1 B0 | 2 x V22148 |
| 1 x V22585 | 1 x YELLOW |
| 1 x V18029 10 | 4 x V225820 |
| 2 x V22106 | |
| 1 x BOX080 | |
| 1 x CPV080 | |
| 2 x V22136 | |

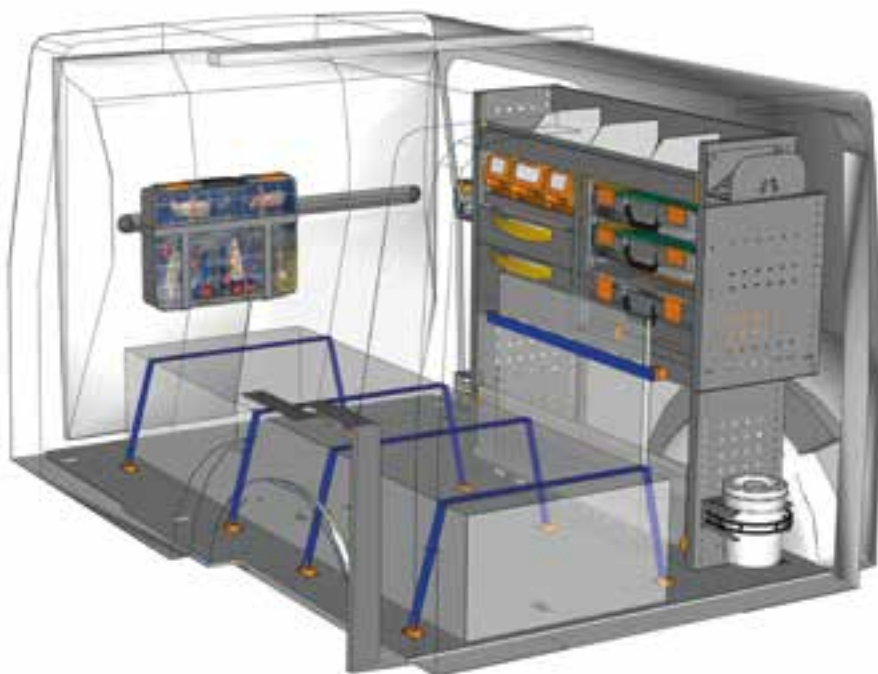

ESEMPIO - EXEMPLE

EXAMPLE KA L2H1 P2*



- | | |
|----------------|-------------|
| 1 x KA 1011 P3 | 2 x V22124 |
| 1 x KA 20K1 B0 | 2 x V22148 |
| 1 x V22585 | 1 x YELLOW |
| 1 x V18029 10 | 4 x V225820 |
| 2 x V22106 | |
| 1 x BOX080 | |
| 1 x CPV080 | |
| 2 x V22136 | |

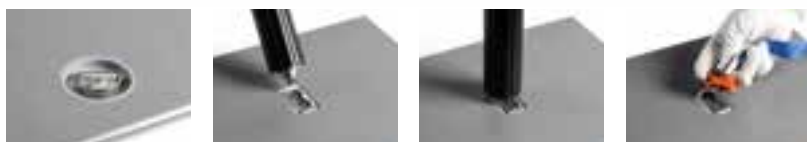

vedi pag. 10/11
voir page 10/11

* Kit fissaggio incluso - Jeu de fixation inclus

Non hai trovato il tuo allestimento?

Affidati ai nostri professionisti

Guarda il retro di questo catalogo e
contatta il punto Store Van piu vicino
oppure visita il nostro sito.

**Vous n'avez pas trouvé votre
équipement ? Confiez-vous
à nos professionnels**

Voir au dos de ce catalogue
et contactez le point StoreVan
le plus proche ou visitez notre site web.





La mobilità oltre il veicolo

La mobilità au-delà du véhicule



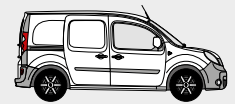

La soluzione MOBILE integra gli allestimenti per veicoli commerciali Store Van con le valigette portaminuterie serie STORE BOX 102 – 136 – 238 e il relativo carrello per facilitare l'utilizzatore dell'**officina mobile** nel trasporto della merce e dell'attrezzatura dal veicolo al luogo di lavoro.

I nuovi elementi di ancoraggio "Airline" aumentano la stabilità del modulo senza influenzarne il peso. Anche in questo caso vengono integrati nella scaffalatura degli elementi che permettono l'uso dei sistemi di trattenuta "Airline". Possono essere scelti sistemi di fissaggio del carico sia verticali che orizzontali grazie anche all'introduzione del pianale SAFETY FLOOR.

La solution MOBILE comprend les aménagements pour véhicules utilitaires Store Van avec les malles pour les petits composants série STORE BOX 102 – 136 – 238 et le chariot pour aider l'utilisateur de **l'atelier mobile** dans les opérations de transport de la marchandise et de l'outillage entre le véhicule et le lieu d'intervention.

Les nouveaux éléments d'arrimage « Airline » améliorent la stabilité du module sans augmenter son poids. Dans ce cas également, des éléments intégrés dans le rayonnage permettent l'utilisation des systèmes de maintien « Airline ». Il est également possible de choisir des systèmes de fixation du chargement aussi bien verticaux qu'horizontaux grâce à l'adoption du plancher SAFETY FLOOR.





L1 H1

RENAULT KANGOO
FURGONE LAMIERATO - FOURGON TÔLÉ

MOBILE

ESEMPIO DI ALLESTIMENTO - EXEMPLES D'AMÉNAGEMENTS

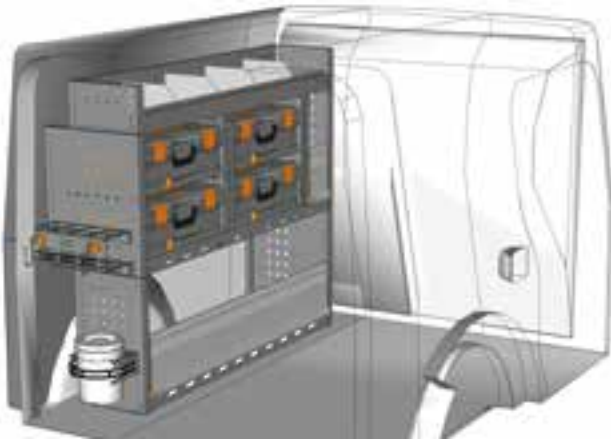

ESEMPIO - EXEMPLE

KA 1211 M1*

L=1225 P=365 H=1050 mm



ESEMPIO - EXEMPLE

KA 1211 M2*

L=1225 P=365 H=1050 mm

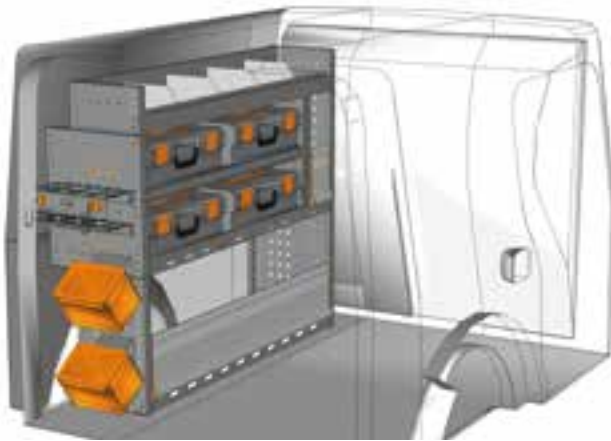
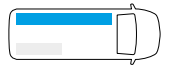

ESEMPIO - EXEMPLE

KA 1211 M3*

L=1225 P=365 H=1050 mm

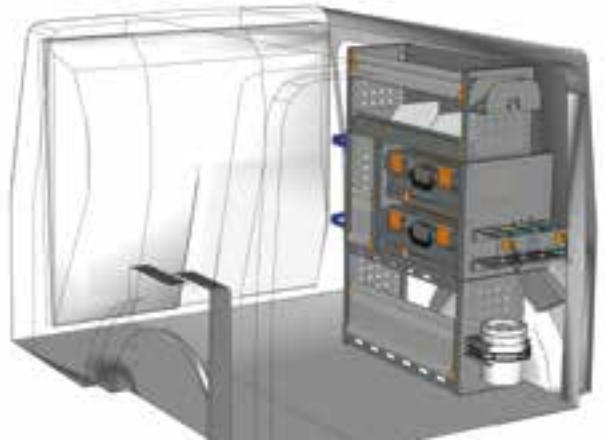

ESEMPIO - EXEMPLE

KA 0711 M1*

L=717 P=365 H=1100 mm

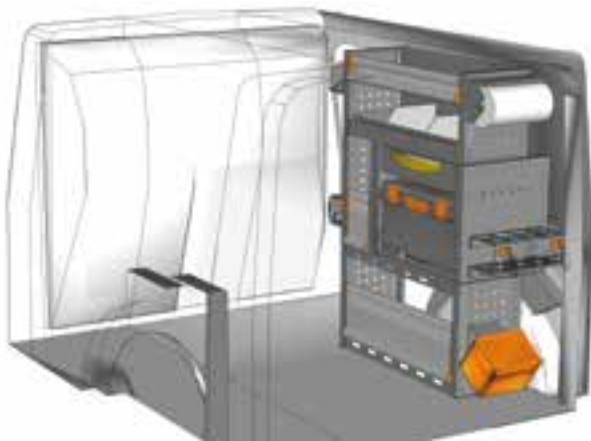
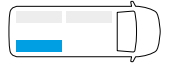

ESEMPIO - EXEMPLE

KA 0711 M2*

L=717 P=365 H=1100 mm

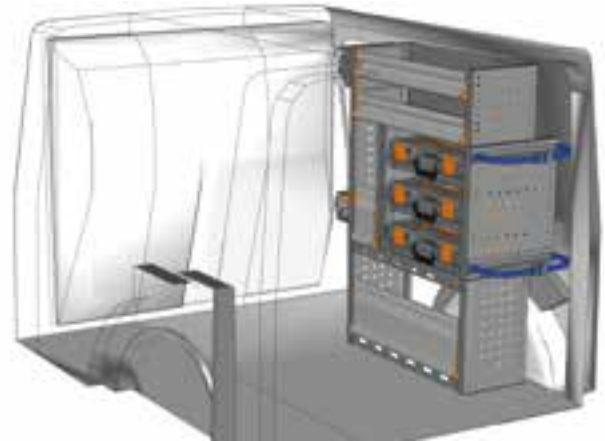
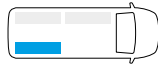

ESEMPIO - EXEMPLE

KA 0711 M3*

L=717 P=365 H=1100 mm



* Kit fissaggio incluso - Jeu de fixation inclus



ESEMPIO DI ALLESTIMENTO - EXEMPLES D'AMÉNAGEMENTS

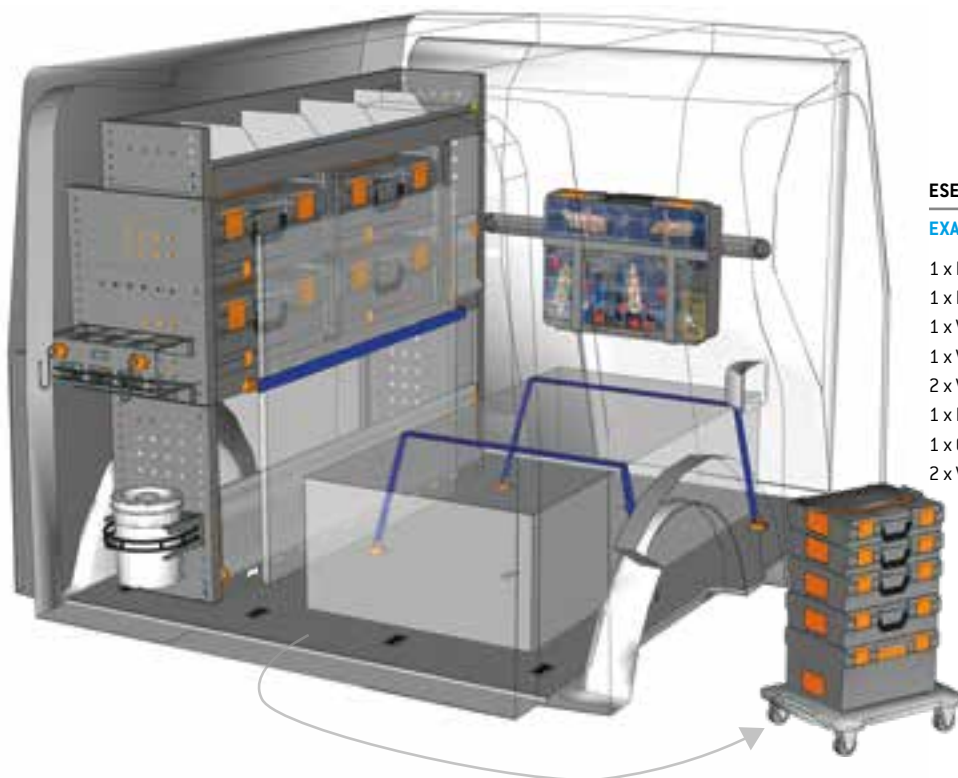

ESEMPIO - EXEMPLE

EXAMPLE KA L1H1 M1*



- | | |
|----------------|-------------|
| 1 x KA 1211 M1 | 2 x V22124 |
| 1 x KA 10K1 B0 | 2 x V22148 |
| 1 x V22585 | 1 x YELLOW |
| 1 x V18029 10 | 4 x V225820 |
| 2 x V22106 | |
| 1 x BOX080 | |
| 1 x CPV080 | |
| 2 x V22136 | |

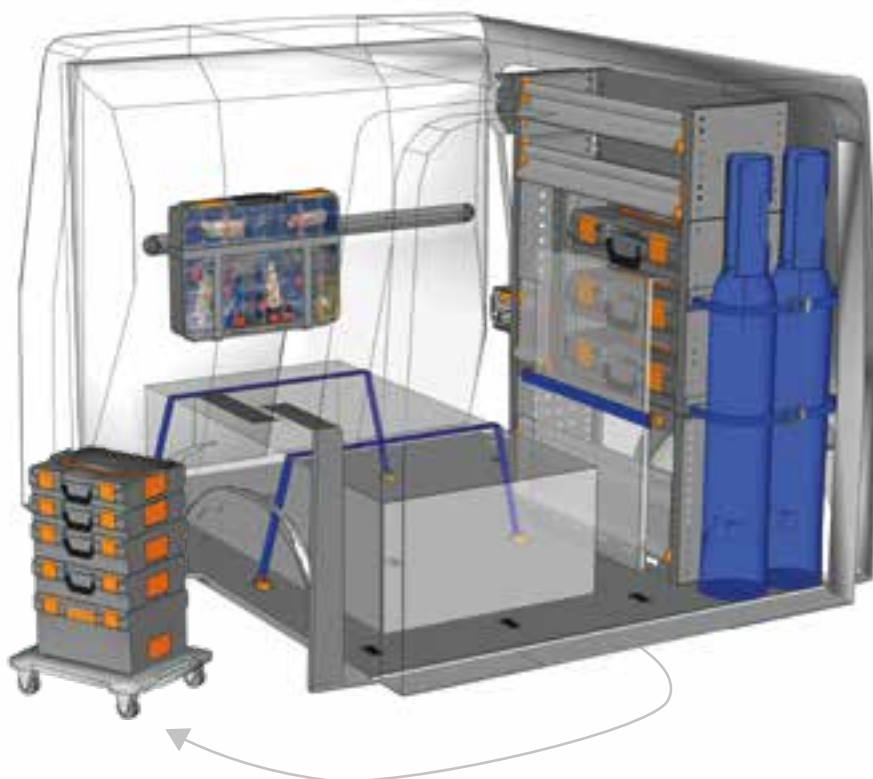

ESEMPIO - EXEMPLE

EXAMPLE KA L1H1 M2*



- | | |
|----------------|-------------|
| 1 x KA 0711 M3 | 2 x V22124 |
| 1 x KA 10K1 B0 | 2 x V22148 |
| 1 x V22585 | 1 x YELLOW |
| 1 x V18029 10 | 4 x V225820 |
| 2 x V22106 | |
| 1 x BOX080 | |
| 1 x CPV080 | |
| 2 x V22136 | |

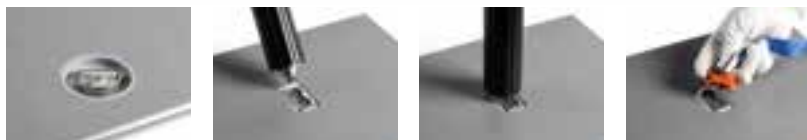

vedi pag. 10/11
voir page 10/11

* Kit fissaggio incluso - Jeu de fixation inclus

Non hai trovato il tuo allestimento?

Affidati ai nostri professionisti

Guarda il retro di questo catalogo e
contatta il punto Store Van piu vicino
oppure visita il nostro sito.

**Vous n'avez pas trouvé votre
équipement ? Confiez-vous
à nos professionnels**

Voir au dos de ce catalogue
et contactez le point StoreVan
le plus proche ou visitez notre site web.



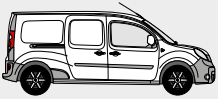

L2 H1

RENAULT KANGOO
FURGONE LAMIERATO - FOURGON TÔLÉ

MOBILE

ESEMPI DI ALLESTIMENTO - EXEMPLES D'AMÉNAGEMENTS

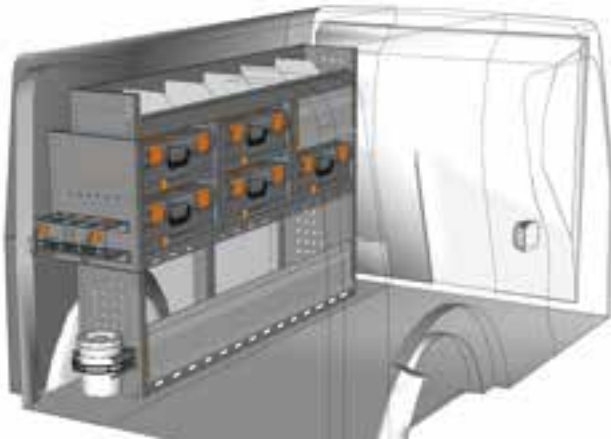

ESEMPIO - EXEMPLE

KA 1511 M1*

L=1524 P=365 H=1050 mm

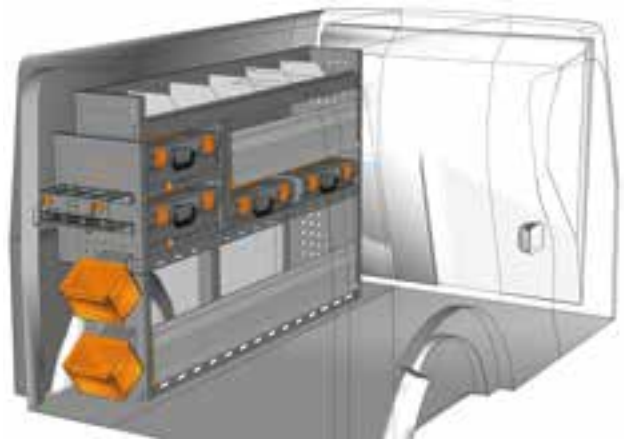
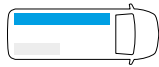

ESEMPIO - EXEMPLE

KA 1511 M2*

L=1524 P=365 H=1050 mm

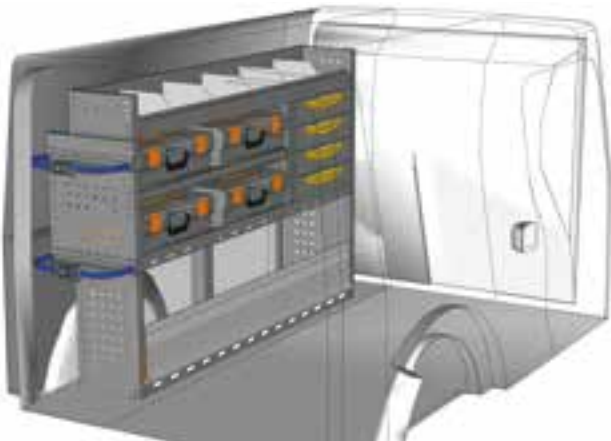
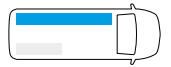

ESEMPIO - EXEMPLE

KA 1511 M3*

L=1524 P=365 H=1050 mm

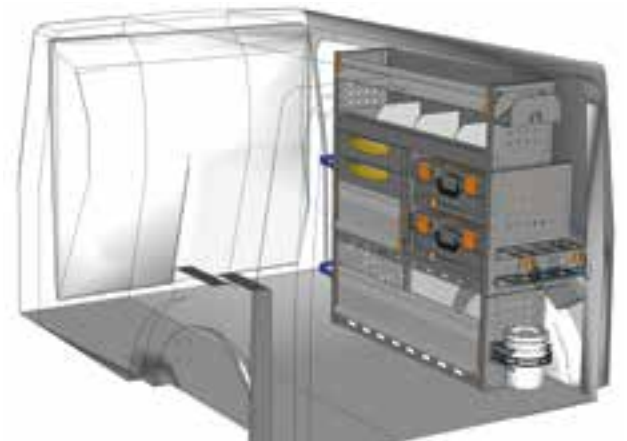
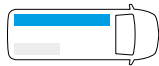

ESEMPIO - EXEMPLE

KA 1011 M1*

L=1016 P=365 H=1100 mm

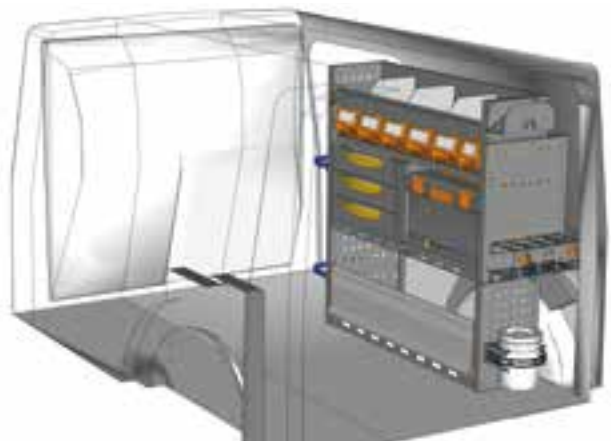
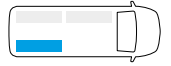

ESEMPIO - EXEMPLE

KA 1011 M2*

L=1016 P=365 H=1050 mm

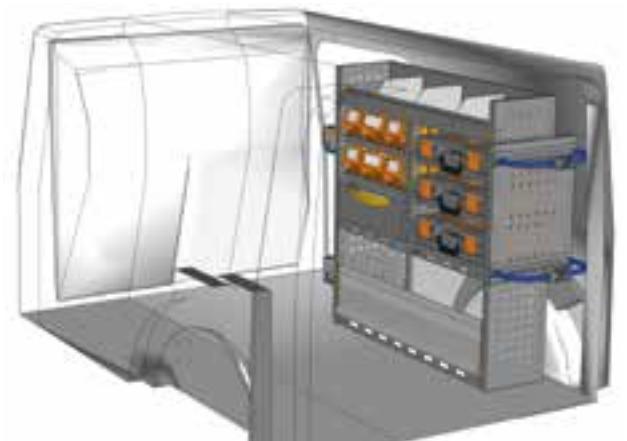
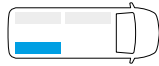

ESEMPIO - EXEMPLE

KA 1011 M3*

L=1016 P=365 H=1050 mm

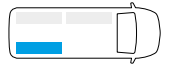

* Kit fissaggio incluso - Jeu de fixation inclus

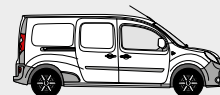

ESEMPIO DI ALLESTIMENTO - EXEMPLES D'AMÉNAGEMENTS

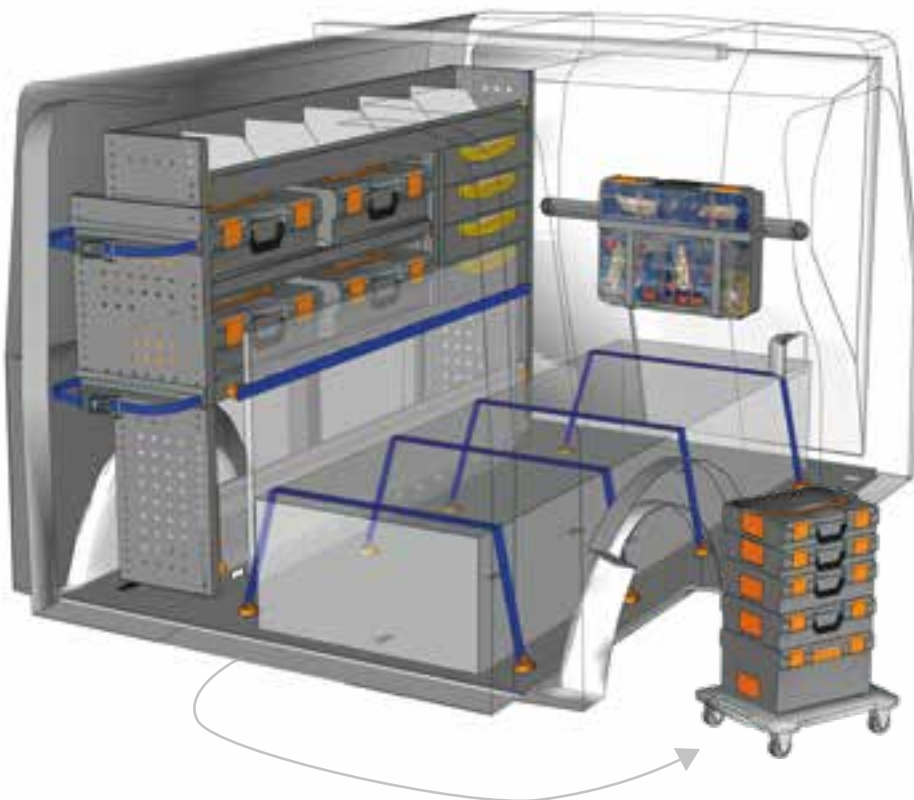

ESEMPIO - EXEMPLE

EXAMPLE KA L2H1 M1*



- | | |
|----------------|-------------|
| 1 x KA 1511 M3 | 2 x V22124 |
| 1 x KA 20K1 B0 | 2 x V22148 |
| 1 x V22585 | 1 x YELLOW |
| 1 x V18029 10 | 4 x V225820 |
| 2 x V22106 | |
| 1 x BOX080 | |
| 1 x CPV080 | |
| 2 x V22136 | |

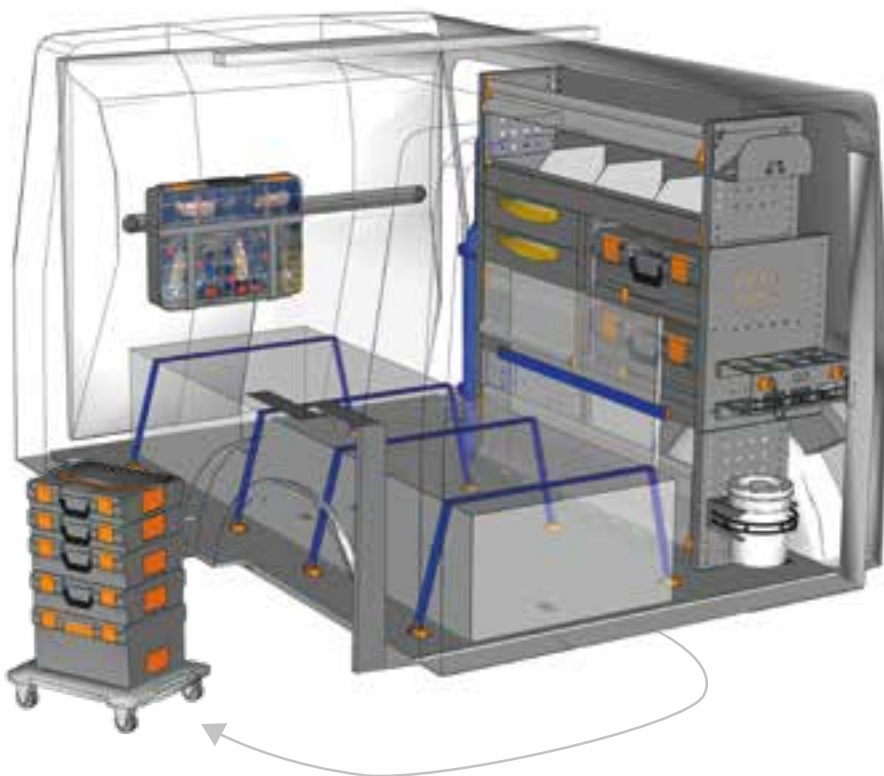

ESEMPIO - EXEMPLE

EXAMPLE KA L2H1 M2*



- | | |
|----------------|-------------|
| 1 x KA 1011 M1 | 2 x V22124 |
| 1 x KA 20K1 B0 | 2 x V22148 |
| 1 x V22585 | 1 x YELLOW |
| 1 x V18029 10 | 4 x V225820 |
| 2 x V22106 | |
| 1 x BOX080 | |
| 1 x CPV080 | |
| 2 x V22136 | |

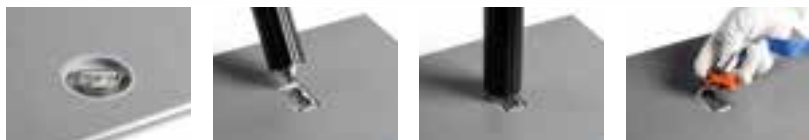

vedi pag. 10/11
voir page 10/11

* Kit fissaggio incluso - Jeu de fixation inclus

Non hai trovato il tuo allestimento?
Affidati ai nostri professionisti
Guarda il retro di questo catalogo e
contatta il punto Store Van piu vicino
oppure visita il nostro sito.

**Vous n'avez pas trouvé votre
équipement ? Confiez-vous
à nos professionnels**
Voir au dos de ce catalogue
et contactez le point StoreVan
le plus proche ou visitez notre site web.



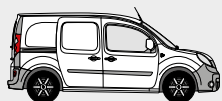

**L'allestimento ergonomico che semplifica
il lavoro in sicurezza**

**L'aménagement ergonomique qui simplifie
le travail en toute sécurité**





FLOOR UP è l'allestimento per furgoni a doppio livello con cassettiere sottopianale sviluppato da Store Van per **migliorare la capacità di carico dei veicoli commerciali con meno di 5 m³ di volume di carico**. Lo stoccaggio e la movimentazione merci sono stati studiati per migliorare l'ergonomia e rendere il trasporto semplice e veloce.

Particolare attenzione è stata dedicata all'utilizzo, e conseguente necessità di trasporto in sicurezza, di utensili, elettroutensili e attrezzature di vario genere.

Questo risultato è stato ottenuto grazie all'introduzione di cassetti sotto pianale particolarmente lunghi e con un ampio volume interno, posti nella parte posteriore e laterale del veicolo in corrispondenza delle porte. Le pareti laterali a tutta altezza del cassetto evitano la fuoriuscita del materiale durante il trasporto.

I cassetti sotto pianale coniugano una elevata portata, **80 kg per cassetto**, con una ampia gamma di materiale di separazione, quali divisori spostabili in alluminio e box in plastica di varie dimensioni per suddividere e bloccare il carico contenuto al loro interno.

Sulla parte superiore dell'allestimento è stato inserito un pianale marino in betulla a 9 strati con uno speciale rivestimento ad alta resistenza e con coefficiente di attrito certificato TÜV. Vengono forniti di serie **12 punti di ancoraggio supplementari AIRLINE** con trazione pari a 200 daN nel rispetto della nuova direttiva comunitaria 2014/47/UE per la sicurezza e fissaggio del carico.

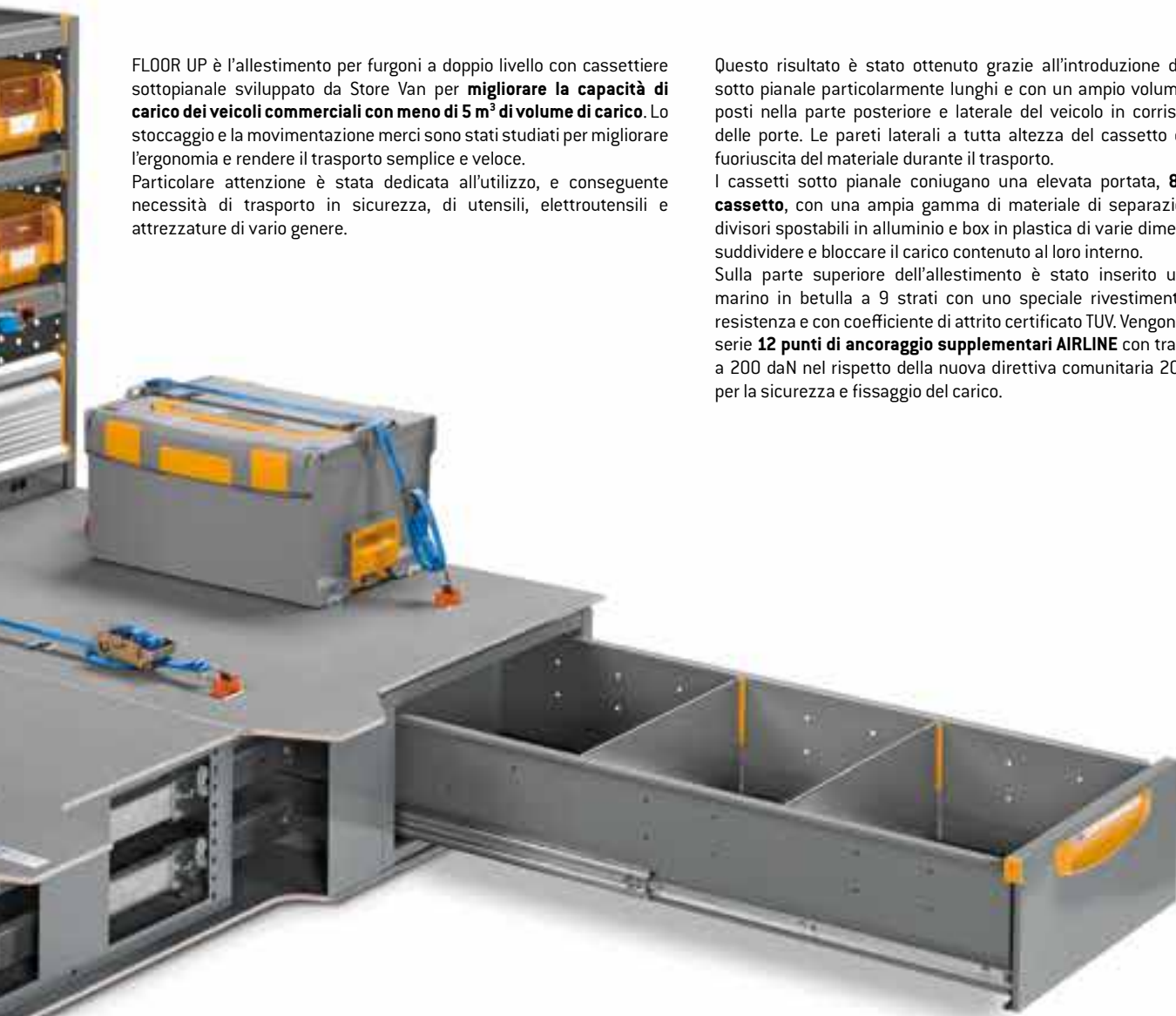

FLOOR UP est l'aménagement pour fourgons à deux niveaux avec blocs-tiroirs sous le plancher développé par Store Van pour **améliorer la capacité de chargement des véhicules utilitaires disposant de moins de 5 m³ de volume de chargement**. Le stockage et la manutention des marchandises ont été étudiés pour améliorer l'ergonomie et rendre le transport simple et rapide. La plus grande attention a été accordée à l'utilisation, et donc aux exigences de transport en toute sécurité, d'outils, d'outillages électriques et d'équipements de différents types. Ce résultat a été obtenu grâce à l'installation sous le plancher de tiroirs particulièrement longs et disposant d'un vaste volume intérieur, placés à l'arrière et sur les côtés du véhicule au niveau des portes. Les parois latérales sur toute la hauteur du tiroir évitent la chute du matériel durant le transport. **Les tiroirs sous le plancher présentent**

une capacité de charge élevée, 80 kg par tiroir, et disposent d'une vaste gamme de matériel de compartimentation, tels que des diviseurs en aluminium déplaçables et des bacs en plastique de différentes dimensions pour diviser et bloquer le matériel contenu dans les tiroirs. Un plancher marin en bouleau à 9 couches, doté d'un revêtement spécial haute résistance et d'un coefficient de frottement certifié TÜV, a été installé sur la partie supérieure de l'aménagement. **12 points d'arrimage supplémentaires AIRLINE**, présentant une traction de 200 daN, conformes à la nouvelle directive européenne 2014/47/UE pour la sécurité et la fixation du chargement, sont fournis de série.

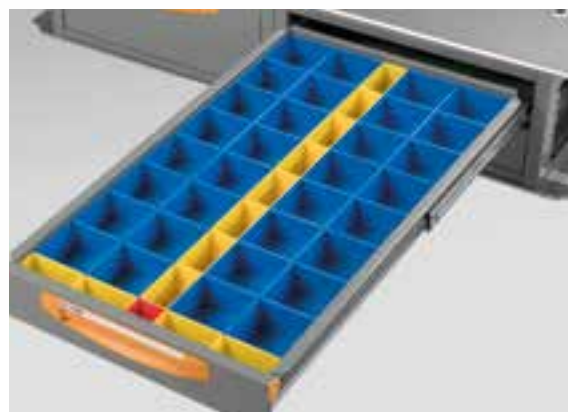



L1 H1

ESEMPI DI ALLESTIMENTO - EXEMPLES D'AMÉNAGEMENTS

PIANALE H 250 mm – PLANCHER H 250 mm



ESEMPIO - EXEMPLE

KA 0250 01*

L=1551 P=1443 H=269 mm
(solo per paratia in lamiera / seulement pour cloison en tôle)



ESEMPIO - EXEMPLE

KA 0250 02*

L=1551 P=1443 H=269 mm
(solo per paratia in lamiera / seulement pour cloison en tôle)



ESEMPIO - EXEMPLE

KA 0250 03*

L=1551 P=1443 H=269 mm
(solo per paratia in lamiera / seulement pour cloison en tôle)



ESEMPIO - EXEMPLE

KA 1207 02*

L=1225 P=365 H=700 mm

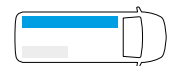

ESEMPIO - EXEMPLE

KA 1207 04*

L=1225 P=365 H=700 mm

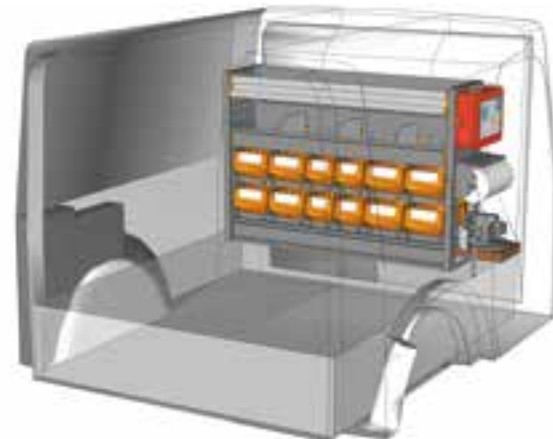
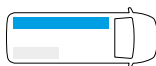

ESEMPIO - EXEMPLE

KA 1007 01*

L=1016 P=265 H=700 mm

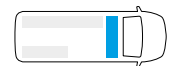

* Kit fissaggio incluso - Jeu de fixation inclus



PIANALE H 250 mm – PLANCHER H 250 mm

ESEMPIO DI ALLESTIMENTO - EXEMPLES D'AMÉNAGEMENTS

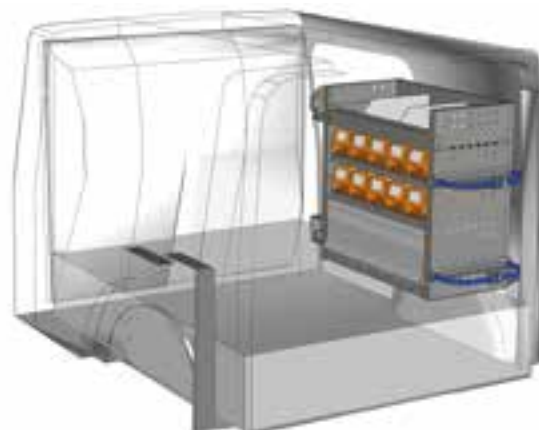
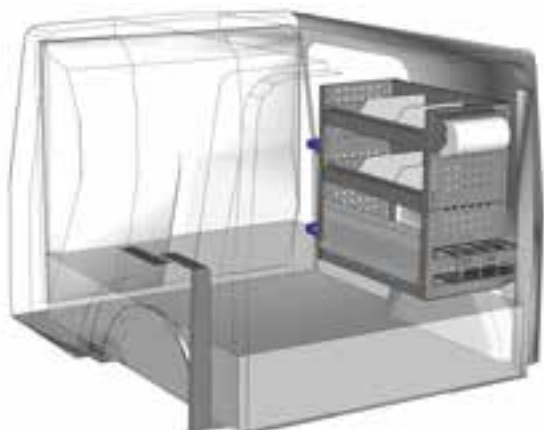

ESEMPIO - EXEMPLE

KA 0707 01*

L=717 P=365 H=700 mm

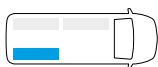

ESEMPIO - EXEMPLE

KA 0707 02*

L=717 P=365 H=700 mm

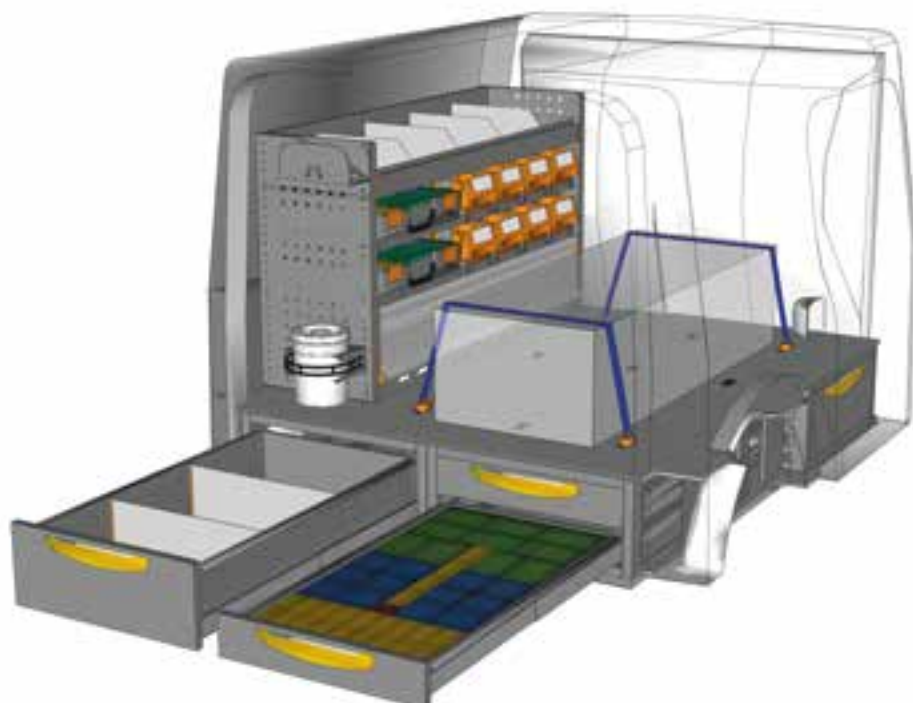
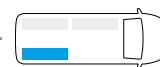

ESEMPIO - EXEMPLE

EXAMPLE KA L1H1 F1*

- 1 x KA 0250 02
- 1 x KA 1207 04
- 1 x E8 093058 B4
- 1 x E8 093058 F0
- 1 x E8 093058 L0
- 1 x E8 108058 B4
- 2 x V22124



vedi pag. 10/11
voir page 10/11

* Kit fissaggio incluso - Jeu de fixation inclus

**Non hai trovato il tuo allestimento?
Affidati ai nostri professionisti**

Guarda il retro di questo catalogo e
contatta il punto Store Van piu vicino
oppure visita il nostro sito.

**Vous n'avez pas trouvé votre
équipement ? Confiez-vous
à nos professionnels**

Voir au dos de ce catalogue
et contactez le point StoreVan
le plus proche ou visitez notre site web.





L1 H1

ESEMPI DI ALLESTIMENTO - EXEMPLES D'AMÉNAGEMENTS

PIANALE H 350 mm – PLANCHER H 350 mm



ESEMPIO - EXEMPLE

KA 0350 01*

L=1511 P=1449 H=369 mm
(solo per paratia in lamiera / seulement pour cloison en tôle)



ESEMPIO - EXEMPLE

KA 0350 02*

L=1511 P=1449 H=369 mm
(solo per paratia in lamiera / seulement pour cloison en tôle)



ESEMPIO - EXEMPLE

KA 0350 03*

L=1511 P=1449 H=369 mm
(solo per paratia in lamiera / seulement pour cloison en tôle)



ESEMPIO - EXEMPLE

KA 1206 02*

L=1225 P=365 H=600 mm

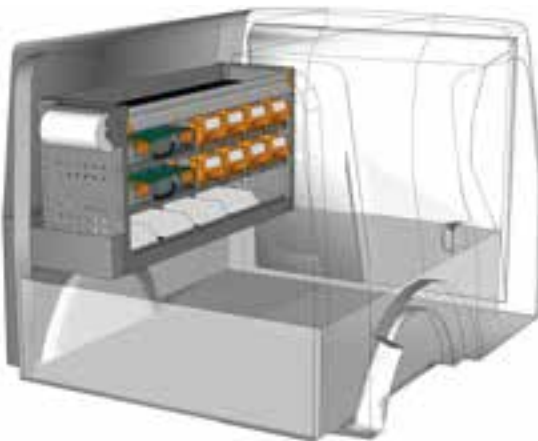

ESEMPIO - EXEMPLE

KA 1206 03*

L=1225 P=365 H=600 mm

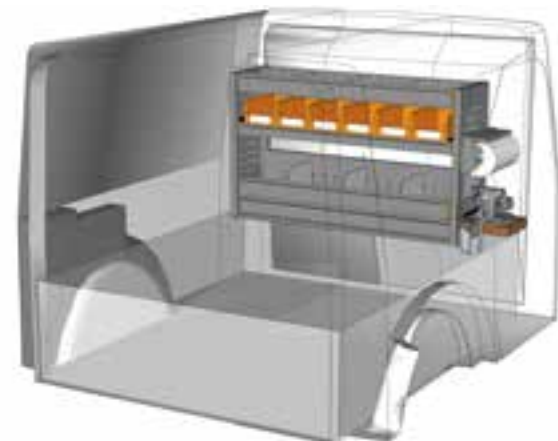
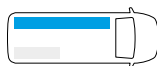

ESEMPIO - EXEMPLE

KA 1006 01*

L=1016 P=265 H=600 mm



* Kit fissaggio incluso - Jeu de fixation inclus



PIANALE H 350 mm – PLANCHER H 350 mm

ESEMPI DI ALLESTIMENTO - EXEMPLES D'AMÉNAGEMENTS

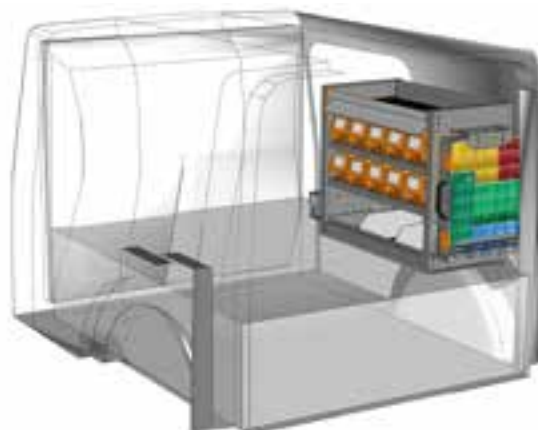
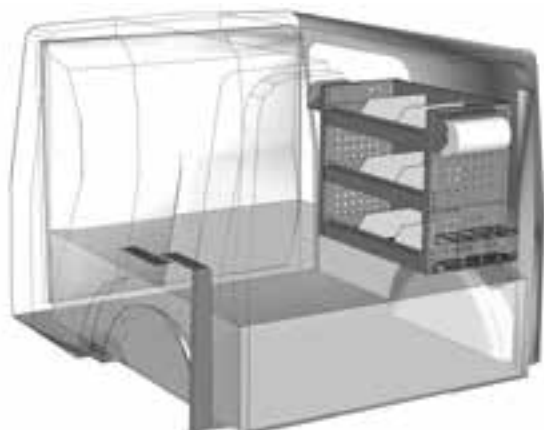

ESEMPIO - EXEMPLE

KA 0706 01*

L=717 P=365 H=600 mm

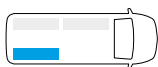

ESEMPIO - EXEMPLE

KA 0706 03*

L=717 P=365 H=600 mm

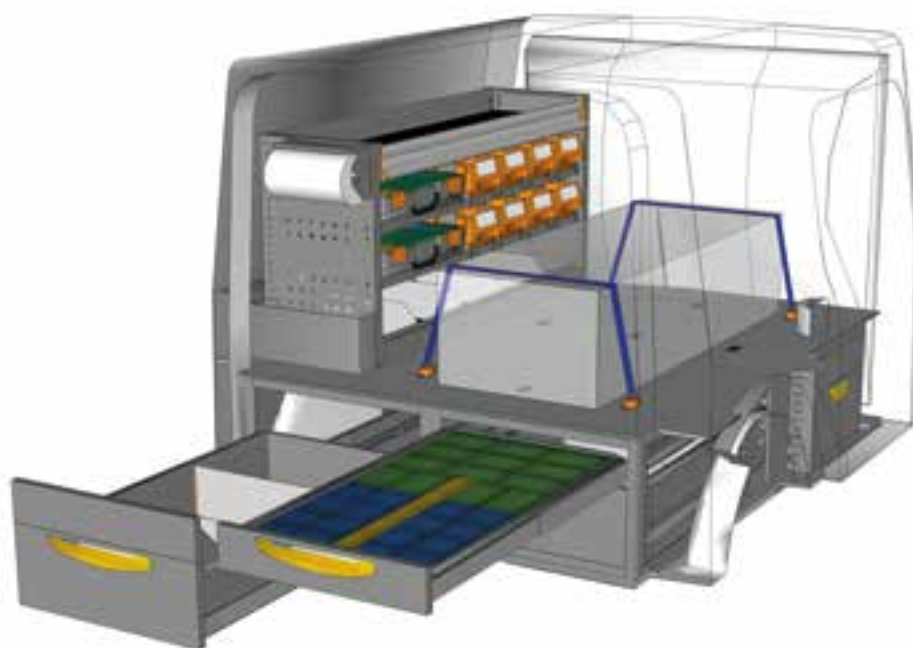
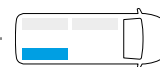

ESEMPIO - EXEMPLE

EXAMPLE KA L1H1 F2*

- 1 x KA 0350 02
- 1 x KA 1206 03
- 2 x E8 093058 B4
- 1 x E8 093058 G0
- 1 x E8 108042 B4
- 2 x V22124



vedi pag. 10/11
voir page 10/11

* Kit fissaggio incluso - Jeu de fixation inclus

Non hai trovato il tuo allestimento?
Affidati ai nostri professionisti
Guarda il retro di questo catalogo e
contatta il punto Store Van piu vicino
oppure visita il nostro sito.

**Vous n'avez pas trouvé votre
équipement ? Confiez-vous
à nos professionnels**
Voir au dos de ce catalogue
et contactez le point StoreVan
le plus proche ou visitez notre site web.



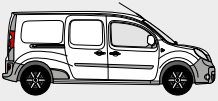

L2 H1

RENAULT KANGOO
FURGONE LAMIERATO - FOURGON TÔLÉ

FLOOR UP 250

ESEMPI DI ALLESTIMENTO - EXEMPLES D'AMÉNAGEMENTS

PIANALE H 250 mm – PLANCHER H 250 mm

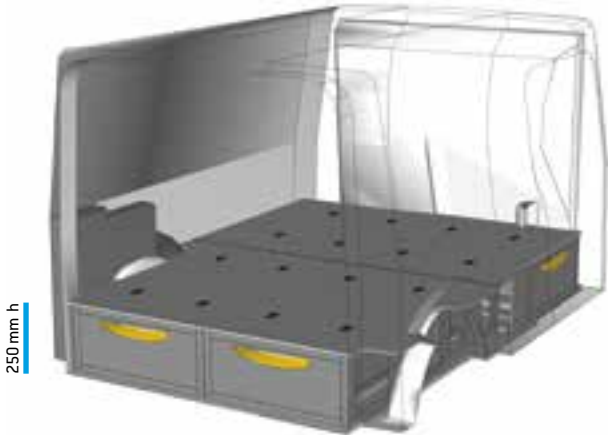

ESEMPIO - EXEMPLE

KA 0250 21*

L=1947 P=1443 H=269 mm
(solo per paratia in lamiera / seulement pour cloison en tôle)



ESEMPIO - EXEMPLE

KA 0250 22*

L=1947 P=1443 H=269 mm
(solo per paratia in lamiera / seulement pour cloison en tôle)

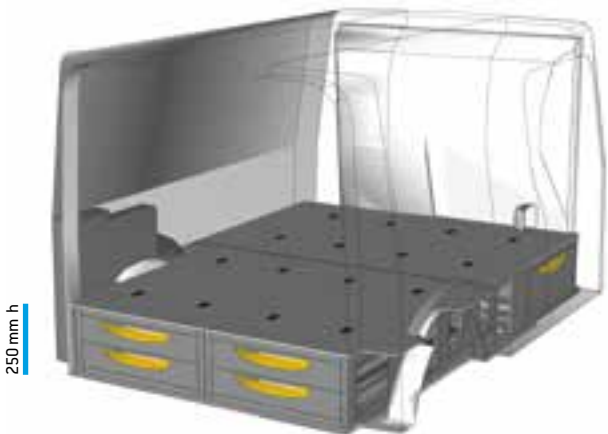
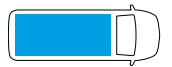

ESEMPIO - EXEMPLE

KA 0250 23*

L=1947 P=1443 H=269 mm
(solo per paratia in lamiera / seulement pour cloison en tôle)



ESEMPIO - EXEMPLE

KA 1007 05*

L=1016 P=365 H=700 mm

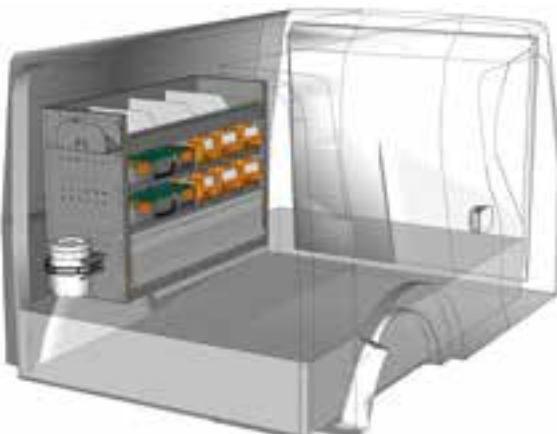
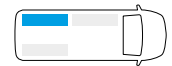

ESEMPIO - EXEMPLE

KA 1007 06*

L=1016 P=365 H=700 mm

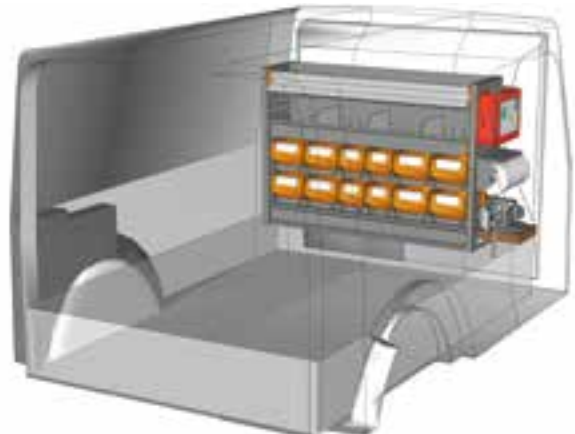
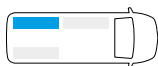

ESEMPIO - EXEMPLE

KA 1007 04*

L=1016 P=265 H=700 mm



* Kit fissaggio incluso - Jeu de fixation inclus



PIANALE H 250 mm – PLANCHER H 250 mm

ESEMPI DI ALLESTIMENTO - EXEMPLES D'AMÉNAGEMENTS



ESEMPIO - EXEMPLE

KA 1007 02*

L=1016 P=365 H=700 mm

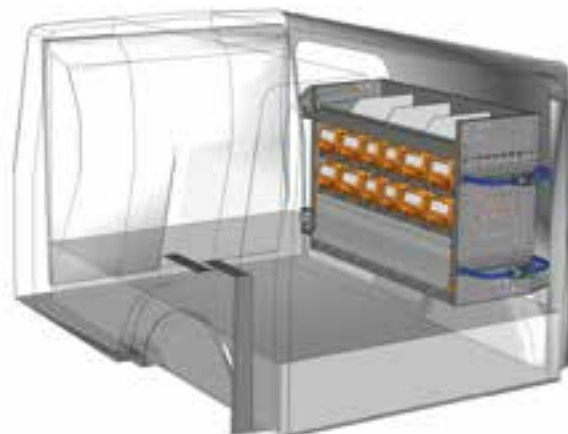
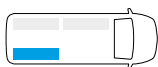

ESEMPIO - EXEMPLE

KA 1007 03*

L=1016 P=365 H=700 mm

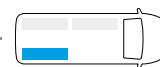

FURGONE LAMIERATO - FOURGON TÔLE
RENAULT KANGOO

FLOOR UP 250

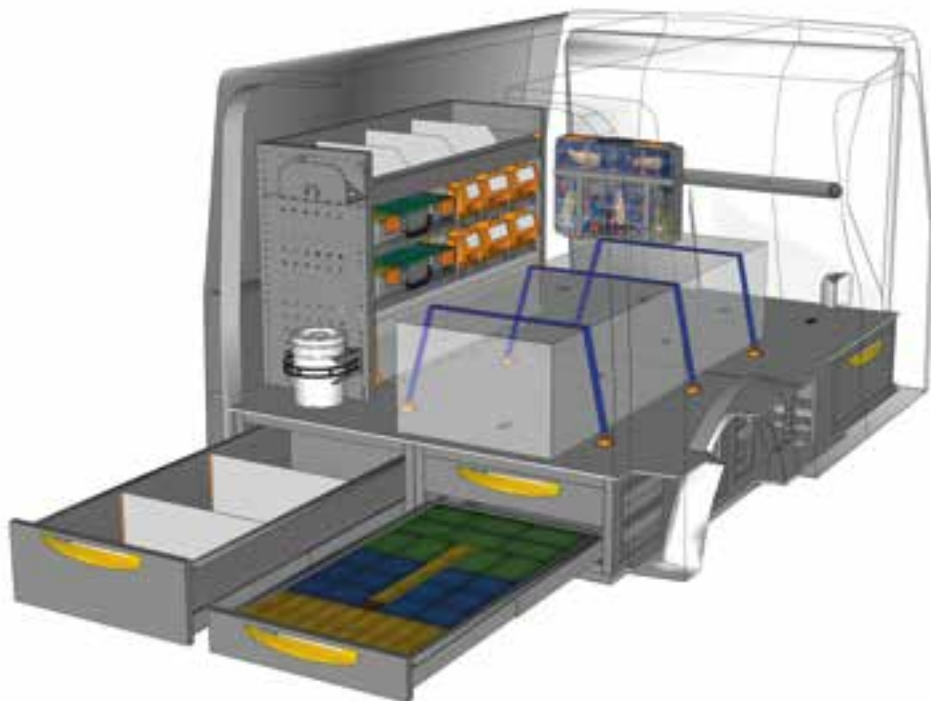

ESEMPIO - EXEMPLE

EXAMPLE KA L2H1 F1*

- | | |
|------------------|-------------|
| 1 x KA 0250 22 | 1 x CPV080 |
| 1 x KA 1007 06 | 2 x V22136 |
| 2 x E8 108058 B4 | 2 x V22124 |
| 1 x E8 093058 F0 | 2 x V22148 |
| 1 x E8 093058 L0 | 1 x YELLOW |
| 1 x V18029 10 | 4 x V225820 |
| 2 x V22106 | |
| 1 x BOX080 | |



vedi pag. 10/11
voir page 10/11

* Kit fissaggio incluso - Jeu de fixation inclus

Non hai trovato il tuo allestimento?

Affidati ai nostri professionisti

Guarda il retro di questo catalogo e
contatta il punto Store Van piu vicino
oppure visita il nostro sito.

**Vous n'avez pas trouvé votre
équipement ? Confiez-vous
à nos professionnels**

Voir au dos de ce catalogue
et contactez le point StoreVan
le plus proche ou visitez notre site web.



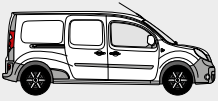

L2 H1

ESEMPI DI ALLESTIMENTO - EXEMPLES D'AMÉNAGEMENTS

PIANALE H 350 mm – PLANCHER H 350 mm



350 mm h

ESEMPIO - EXEMPLE

KA 0350 21*

L=1909 P=1449 H=369 mm
(solo per paratia in lamiera / seulement pour cloison en tôle)



350 mm h

ESEMPIO - EXEMPLE

KA 0350 22*

L=1909 P=1449 H=369 mm
(solo per paratia in lamiera / seulement pour cloison en tôle)



350 mm h

ESEMPIO - EXEMPLE

KA 0350 23*

L=1909 P=1449 H=369 mm
(solo per paratia in lamiera / seulement pour cloison en tôle)



ESEMPIO - EXEMPLE

KA 1006 05*

L=1016 P=365 H=600 mm

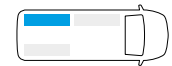

ESEMPIO - EXEMPLE

KA 1006 06*

L=1016 P=365 H=600 mm

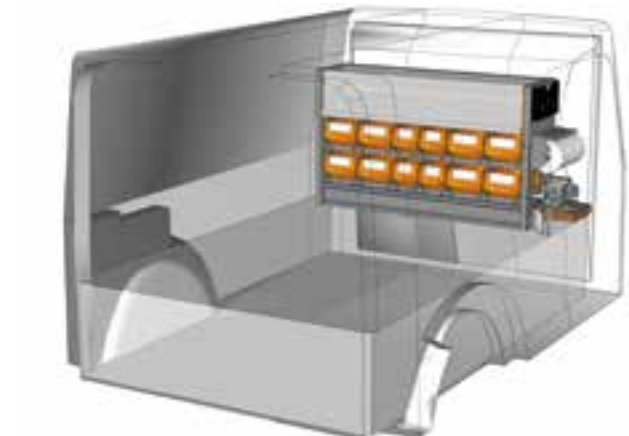
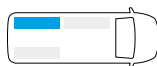

ESEMPIO - EXEMPLE

KA 1006 04*

L=1016 P=265 H=600 mm

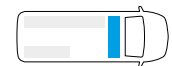

* Kit fissaggio incluso - Jeu de fixation inclus

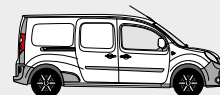

PIANALE H 350 mm – PLANCHER H 350 mm

ESEMPI DI ALLESTIMENTO - EXEMPLES D'AMÉNAGEMENTS

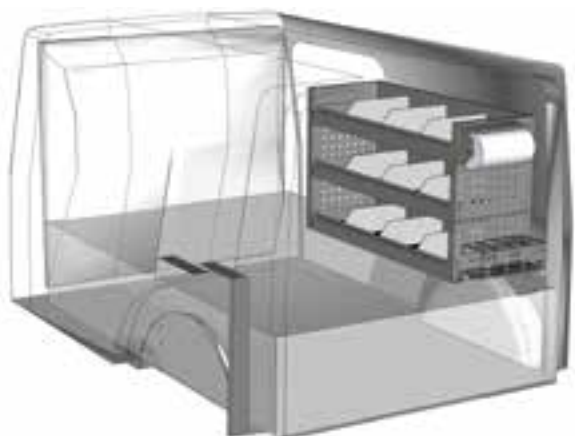

ESEMPIO - EXEMPLE

KA 1006 02*

L=1016 P=365 H=600 mm

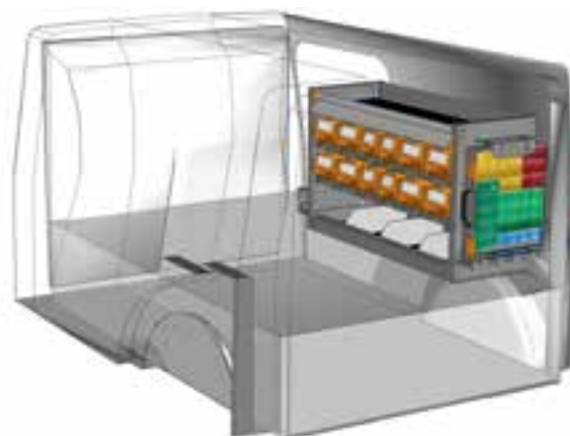
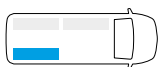

ESEMPIO - EXEMPLE

KA 1006 03*

L=1016 P=365 H=600 mm

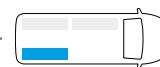

FURGONE LAMIERATO - FOURGON TÔLE
RENAULT KANGOO

FLOOR UP 350

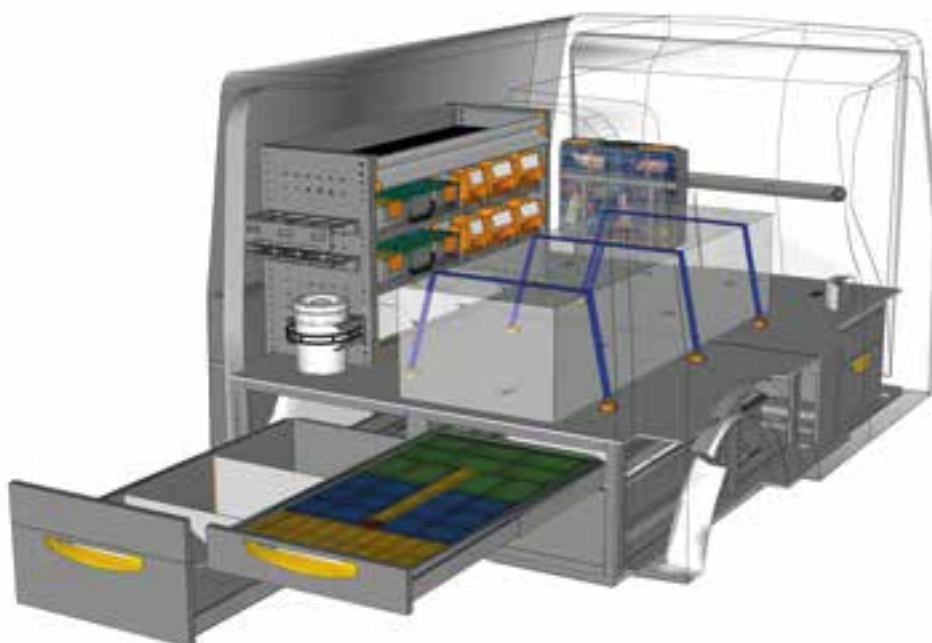

ESEMPIO - EXEMPLE

EXAMPLE KA L2H1 F2*

- | | |
|------------------|-------------|
| 1 x KA 0350 22 | 1 x CPV080 |
| 1 x KA 1006 06 | 2 x V22136 |
| 2 x E8 108058 B4 | 2 x V22124 |
| 1 x E8 093058 L0 | 2 x V22148 |
| 1 x E8 108042 B4 | 1 x YELLOW |
| 1 x V18029 10 | 4 x V225820 |
| 2 x V22106 | |
| 1 x BOX080 | |



vedi pag. 10/11
voir page 10/11

* Kit fissaggio incluso - Jeu de fixation inclus

Non hai trovato il tuo allestimento?

Affidati ai nostri professionisti

Guarda il retro di questo catalogo e
contatta il punto Store Van piu vicino
oppure visita il nostro sito.

**Vous n'avez pas trouvé votre
équipement ? Confiez-vous
à nos professionnels**

Voir au dos de ce catalogue
et contactez le point StoreVan
le plus proche ou visitez notre site web.



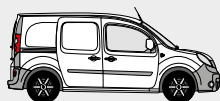

VEICOLO VÉHICULE	PORTATUTTO GALERIE DE TOIT ART.	DIMENSIONI DIMENSIONS	PESO POIDS	PORTATA CHARGE
Modello - Modèle L0 H1 Compact	POT 201	1800x1400 mm	20,04 kg	69,00 kg
Modello - Modèle L1 H1	POT 202	2000x1400 mm	20,88 kg	68,00 kg
Modello - Modèle L2 H1 Maxi	POT 217	2500x1400 mm	23,18 kg	66,00 kg

- POT**
- Portatutto completo di:
 - barre in alluminio complete di attacchi e profilo in gomma
 - sponde laterali in alluminio
 - rullo di caricamento in alluminio
 - viterie di fissaggio fornite in acciaio inox
 - Galerie de toit complète de :
 - barres en aluminium avec fixations et profil en caoutchouc
 - rebords latéraux en aluminium
 - rouleau de chargement en aluminium
 - visserie de fixation fournie en acier inox

- Solo per veicolo con porte posteriori a battente.
- Seulement pour véhicule avec portes arrière battantes.



VEICOLO VÉHICULE	PORTASCALE PORTE-ÉCHELLES ART.	DIMENSIONI DIMENSIONS	PESO POIDS	PORTATA CHARGE
Modello - Modèle L0 H1 Compact	POS 201	2110x1380 mm	41,98 kg	48,00 kg
Modello - Modèle L1 H1	POS 202	2110x1380 mm	43,30 kg	46,00 kg
Modello - Modèle L2 H1 Maxi	POS 217	2650x1380 mm	46,97 kg	43,00 kg

- POS**
- Portascale completo di:
 - barre in alluminio complete di attacchi e profilo in gomma
 - sponda laterale in alluminio
 - rullo di caricamento in alluminio
 - slitta portascale in alluminio e acciaio inox
 - viterie di fissaggio fornite in acciaio inox
 - Porte-échelles complet de :
 - barres en aluminium avec fixations et profil en caoutchouc
 - rebord latéral en aluminium
 - rouleau de chargement en aluminium
 - chariot porte-échelles en aluminium et acier inox
 - visserie de fixation fournie en acier inox

- Solo per veicolo con porte posteriori a battente.
La slitta portascale può essere montata a destra o a sinistra.
- Seulement pour véhicule avec portes arrière battantes.
Le chariot porte-échelles peut être monté à droite ou à gauche.



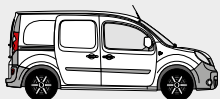

ART. **PAP 265 00**

- Kit porta rotolo con carta Ø 130 mm
- Set support avec rouleau de papier Ø 130 mm

ART. **CAB 220 00**

- Sella reggicavi
- Support pour câbles

ART. **SPR 365 00**

- Porta bombolette P=365 mm
- Porte bombes aérosol P=365 mm

ART. **PAP 365 00**

- Kit porta rotolo con carta Ø 240 mm
- Set support avec rouleau de papier Ø 240 mm

ART. **CAB 296 00**

- Kit sella reggicavi
- Jeu support pour câbles

ART. **SIL 296 00**

- Kit porta silicone - bombolette
- Set porte silicon - bombes aérosols

ART. **LED 001 00**

- Lampada a led IP20 12V L=600mm
- Lampe à led IP20 12V L=600mm

ART. **WAS 365 00**

- Kit lavamani
- Set lavage des mains

ART. **AID 265 00**

- Kit pronto soccorso
- Trousse de premier secours

ART. **DOC 265 00**

- Tasca porta documenti DIN A4
- Pochette porte documents DIN A4

ART. **MAG 020**

- Kit 10 calamite Ø 20 mm
- Set de 10 aimants Ø 20mm

ART. **MAG 025**

- Kit 10 calamite Ø 25 mm
- Set de 10 aimants Ø 25mm



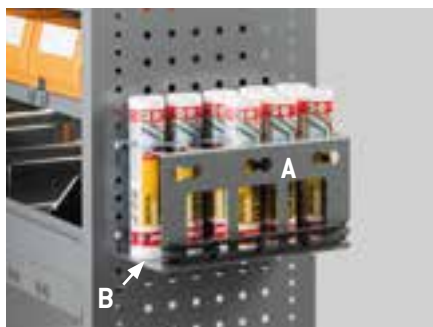

ART. **BAR 296 00** A

- Kit porta barre filettate
- Jeu porte-barres filetées

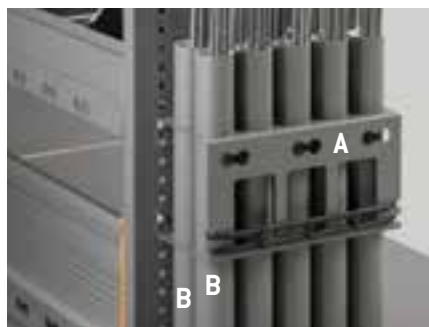

ART. **BAR 296 00** A

- Kit porta barre filettate
- Jeu porte-barres filetées

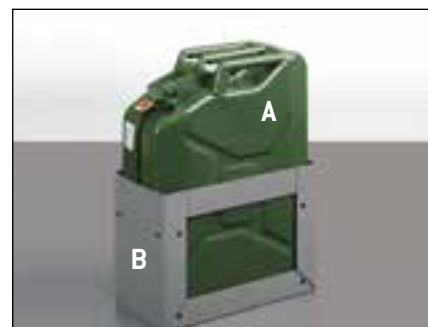

ART. **OIL 20L 00** A

- Tanica in ferro capacità 20 LT
- Bidon en fer 20 LT

ART. **BAR 296 02** B

- Adattatore per cartucce silicone
- Adaptateur pour cartouches silicone

ART. **BAR 296 01** B

- Kit 5 tubi per porta barre filettate
- Jeu de 5 tuyaux pour porte-barres filetées

ART. **OIL 365 00** B

- Porta tanica
- Porte - bidon

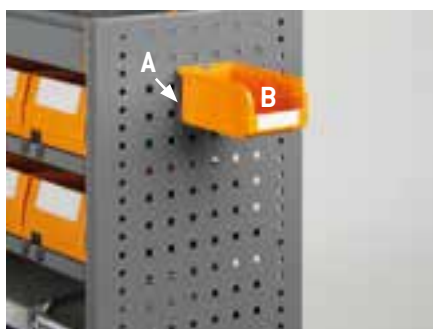

ART. **BL 7433 00** A

- Barra aggancio per 1 contenitore misura 1PL
- Barre porte bac pour 1 bac mesure 1PL

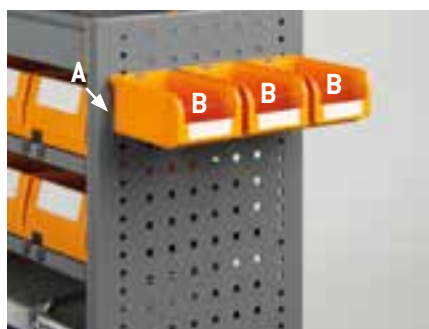

ART. **BL 7434 00** A

- Barra aggancio per 3 contenitori misura 1PL
- Barre porte bac pour 3 bacs mesure 1PL

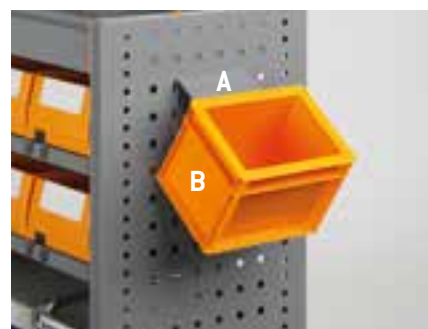

ART. **BL 7432 00** A

- Barra aggancio per 1 contenitore Athena
- Barre porte bac pour 1 bac Athena

ART. **PM 1751 00** B

- Contenitore in polipropilene misura 1PL
- Bac en polypropylène mesure 1PL

ART. **PM 1751 00** B

- Contenitore in polipropilene misura 1PL
- Bac en polypropylène mesure 1PL

ART. **PA 2251 A0** B

- Cassetta in polipropilene serie Athena
- Caisse en polypropylène série Athena





ART. **FIR 000** A

- Kit porta bombole
- Set support pour bouteilles de gaz

ART. **FIR 4KG** B

- Estintore polvere 4 KG
- Extincteur (poudre) 4 KG



ART. **V18029 03** A

- Barra orizzontale fermacarico attacco foro medium L=365 mm
- Barre horizontale d'arrimage fixations trou medium L=365 mm

ART. **V18029 04** A

- Barra orizzontale fermacarico attacco foro medium L=445 mm
- Barre horizontale d'arrimage fixations trou medium L=445 mm

ART. **V22868** B

- Cinghia fermacarico con cricchetto attacco innesto medium
- Sangle d'arrimage à cliquet pour fixations medium

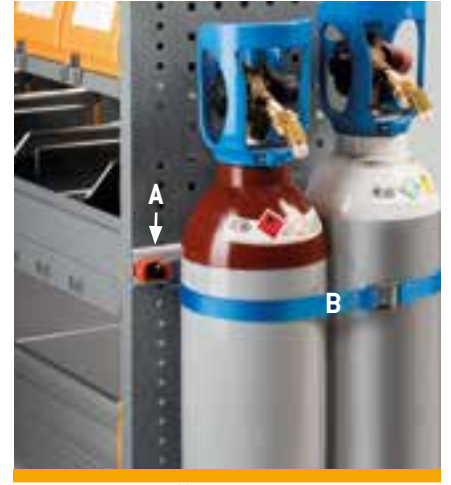

ART. **V18029 03** A

- Barra orizzontale fermacarico attacco foro medium L=365 mm
- Barre horizontale d'arrimage fixations trou medium L=365 mm

ART. **V18029 04** A

- Barra orizzontale fermacarico attacco foro medium L=445 mm
- Barre horizontale d'arrimage fixations trou medium L=445 mm

ART. **V22869** B

- Cinghia fermacarico con morsetto attacco innesto medium
- Sangle d'arrimage avec serrage pour fixations medium



Esempio con
2 ART. FIR 000
Exemple avec
2 ART. FIR 000

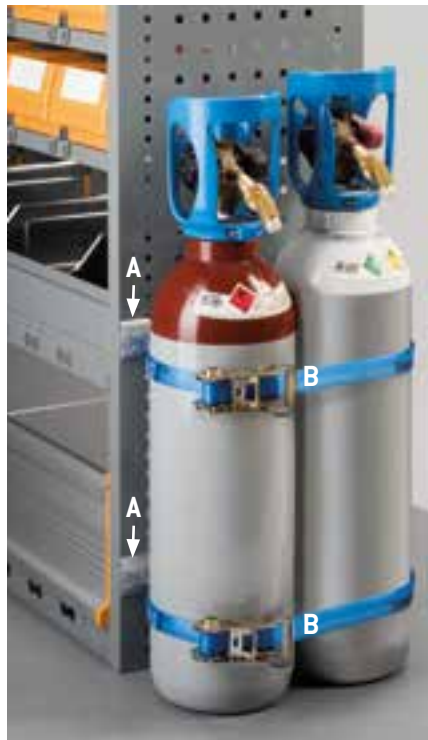

Esempio con
2 ART. V18029 03
2 ART. V22868
Exemple avec
2 ART. V18029 03
2 ART. V22868

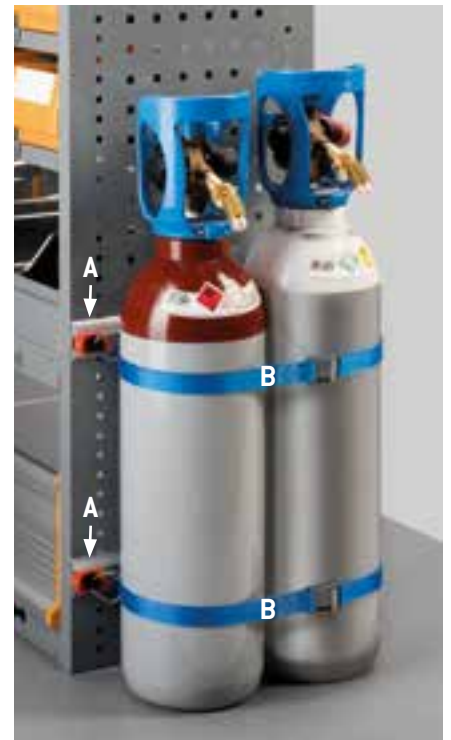

Esempio con
2 ART. V18029 03
2 ART. V22869
Exemple avec
2 ART. V18029 03
2 ART. V22869

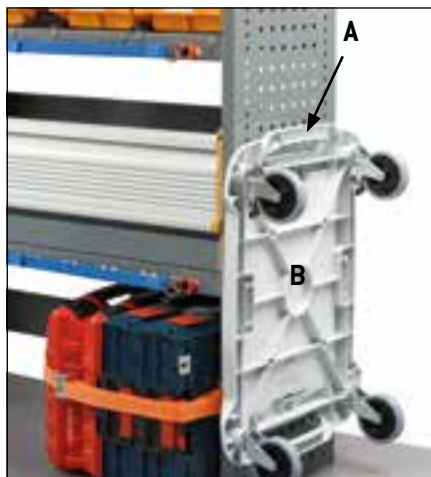

ART.

00 ROLL SU

A

- Kit supporti per STORE BOX ROLL
- Kit de supports pour STORE BOX ROLL

ART.

00 ROLL 00

B

- Carrello con ruote con freni per valigetta BOX 102-136-238-374
- Plateau roulant à frein pour mallette BOX 102-136-238-374



FURGONE LAMIERATO - FOURGON TÔLE
RENAULT KANGOO



RENAULT KANGOO

CONDIZIONI DI FORNITURA

- Pianali e pannellature forniti in più pezzi.
- Portatutto e portascale vengono forniti **smontati**.
- I moduli vengono forniti **preassemblati** completi del materiale di ancoraggio al veicolo.
- Per l'installazione dei prodotti si consiglia di rivolgersi alla nostra rete di **installatori autorizzati**.
- I prodotti vengono forniti completi di **imballo**.
- **3 anni di garanzia** sui nostri prodotti.
- Le portate si riferiscono a **peso uniformemente distribuito**.

CONDITIONS DE FOURNITURE

- Planchers et habillages fournis en plusieurs éléments.
- Galeries de toit et porte-échelles sont fournis **démontés**.
- Les modules sont fournis **pré-montés**, avec le matériel de fixation au véhicule.
- Pour l'installation des produits, il est conseillé de s'adresser à notre réseau d'**installateurs agréés**.
- Les produits sont fournis **emballés**.
- **3 ans de garantie** sur nos produits.
- Les capacités de charge se réfèrent à **charge uniformément répartie**.



FAMI S.R.L.

VIA STAZIONE ROSSANO, 13 – 36027 ROSÀ (VI) ITALY
TEL +39 0424 585455 R.A. – FAX +39 0424 585482
INFO@FAMISPA.COM – WWW.FAMISPA.COM

INFO@STOREVAN.COM – WWW.STOREVAN.COM

