

**ROBUST, VIELSEITIG, PERSONALISIERBAR**

**2 FACHBODENTYPEN, 2 FARBEN**

**SCHUBLADEN MIT EINFACHAUSZUG**

**ZYLINDERSCHLOSS**

**V E R S C H I E D E N E**

**KOMBINATIONSMÖGLICHKEITEN**

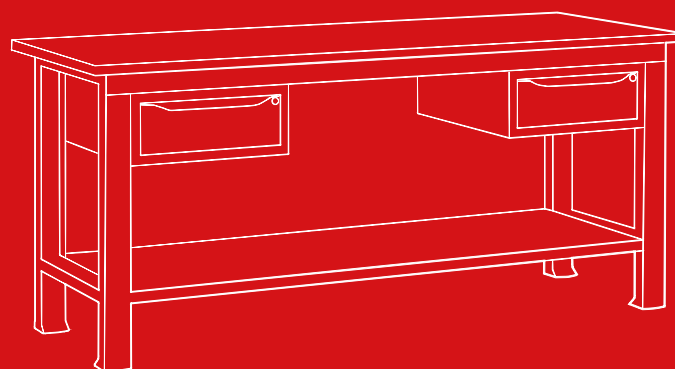



# WORK STEEL

# TECHNISCHE EIGENSCHAFTEN

## WERKBANK FARBEN

2 Farben für die Metallteile

RAL 5012

RAL 7035



MULTIPLEX  
AUS BUCHENHOLZ

Dicke 30 mm

OBERE PLATTE AUS STAHL



Dicke 3 mm



## SCHRÄNKE MIT SCHUBLADEN

Die Schubladen und die Tür werden mit Zylinderschloss und 2 Schlüsseln geliefert. Die Schublade mit höchst resistentem und gleitfähigem Lager ist mit einem Öffnungsfeststeller ausgestattet, der das Herunterfallen verhindert.

In 3 verschiedenen Konfigurationen erhältlich.

 TRAGKRAFT SCHUBLADEN SIEHE S. 777

## STRUKTUR

Die Grundstruktur aus robustem Stahlblech besteht aus Werkbankfüßen, oberen Traversen und einem unteren Fachboden mit einer Tragfähigkeit von 250 kg, die mit Schrauben miteinander verbunden eine Tragfähigkeit von 1000 kg garantieren.



AUF ANFRAGE KÖNNEN RÜCKWANDAUFBAUTEN  
EINGESETZT WERDEN UM IHRE WERKBANK ZU  
KOMPLETTIEREN  
SIEHE S. 859





## ZUBEHÖRE

Die Werkbänke sind für die Ausstattung mit seitlichen und rückseitigen Wänden vorgesehen, sowie mit höhenverstellbaren Zwischenböden mit oder ohne Schlitz, die jederzeit hinzugefügt werden können. Die Schlitz erlauben das Einsetzen von Führungen und Behältern aus Kunststoff der Serie **RK** und bieten den Vorteil, auf der Werkbank ein kleines Lager für Kleinteile, Komponenten und Ersatzteile gestalten zu können.





● **ART. F BG M1B0 00 04**  
H = 855 mm - 3 Schubladen

 Farbauswahl STAHL



BLAU  
RAL 5012  
.04



GRAU  
RAL 7035  
.08

**OBERE PLATTE AUS STAHL**



KONFIGURIEREN SIE IHRE WERKBANK AB S. 775



RÜCKWANDAUFBAUTEN SIEHE S. 859

## ZEICHEN- ERKLÄRUNG



MONTIERTE  
WERKBANK



DEMONTIERTE  
WERKBANK



VERSCHLUSS



TRAGKRAFT  
DER  
WERKBANK

**!** DIE TRAGKRAFTANGABEN SIND NETTOANGABEN UND BEZIEHEN SICH AUF GLEICHMÄSSIG VERTEILTE GEWICHTE



geschlossene Wände

ART.			
F BG M100 00 04		-	1000
F BG S100 00 04		-	1000

ART.			
F BG M100 01 04		-	1000
F BG S100 01 04		-	1000



geschlossene Wände

1 Schublade

ART.			
F BG M100 52 04		-	1000
F BG S100 52 04		-	1000

ART.			
F BG M1A0 00 04		key	1000
F BG S1A0 00 04		key	1000

Komplett mit 4 "RK" ART. FP RK 5012 000 51 04, 6 "RK" ART. FP RK 6016 0000 51 04, 2 grauen Behälter COMPAT Gr. 4 ART. FP CO C004 B 00 51 01



3 Schubladen

1 Schublade + 1 Tür

ART.			
● F BG M1B0 00 04		key	1000
F BG S1B0 00 04		key	1000

ART.			
F BG M1C0 00 04		key	1000
F BG S1C0 00 04		key	1000



● ART. F BG M2B0 00 04  
H = 855 mm - 3 Schubladen

 Farbauswahl STAHL



BLAU  
RAL 5012  
.04



GRAU  
RAL 7035  
.08

OBERE PLATTE AUS STAHL



KONFIGURIEREN SIE IHRE WERKBANK AB S. 775



RÜCKWANDAUFBAUTEN SIEHE S. 859

## ZEICHEN- ERKLÄRUNG



MONTIERTE  
WERKBANK



DEMONTIERTE  
WERKBANK



VERSCHLUSS



TRAGKRAFT  
DER  
WERKBANK

! DIE TRAGKRAFTANGABEN SIND NETTOANGABEN UND BEZIEHEN SICH AUF GLEICHMÄSSIG VERTEILTE GEWICHTE



ART.			kg
F BG M200 00 04		-	1000
F BG S200 00 04		-	1000



1 Schublade

ART.			kg
F BG M2A0 00 04		key	1000
F BG S2A0 00 04		key	1000



3 Schubladen

ART.			kg
● F BG M2B0 00 04		key	1000
F BG S2B0 00 04		key	1000



3 Schubladen

geschlossene Wände

ART.			kg
F BG M2B0 01 04		key	1000
F BG S2B0 01 04		key	1000



3 Schubladen

geschlossene Wände

ART.			kg
F BG M2B0 52 04		key	1000
F BG S2B0 52 04		key	1000



4 Schubladen + 1 Tür

ART.			kg
F BG M2BC 00 04		key	1000
F BG S2BC 00 04		key	1000

Komplett mit 4 "RK" ART. FP RK 5012 000 51 04, 6 "RK" ART. FP RK 6016 0000 51 04, 2 grauen Behälter COMPAT Gr. 4 ART. FP CO C004 B 00 51 01





● **ART. F BG M3B0 00 04**  
H = 855 mm - 3 Schubladen

 Farbauswahl STAHL



BLAU  
RAL 5012  
.04



GRAU  
RAL 7035  
.08

**OBERE PLATTE AUS STAHL**



KONFIGURIEREN SIE IHRE WERKBANK AB S. 775



RÜCKWANDAUFBAUTEN SIEHE S. 859

## ZEICHEN- ERKLÄRUNG



MONTIERTE  
WERKBANK



DEMONTIERTE  
WERKBANK



VERSCHLUSS



TRAGKRAFT  
DER  
WERKBANK



DIE TRAGKRAFTANGABEN SIND NETTOANGABEN UND BEZIEHEN SICH AUF GLEICHMÄSSIG VERTEILTE GEWICHTE



1 Schublade

ART.			
F BG M300 00 04		-	1000
F BG S300 00 04		-	1000

ART.			
F BG M3A0 00 04		key	1000
F BG S3A0 00 04		key	1000



2 Schubladen

3 Schubladen

ART.			
F BG M3AA 00 04		key	1000
F BG S3AA 00 04		key	1000

ART.			
• F BG M3B0 00 04		key	1000
F BG S3B0 00 04		key	1000



3 Schubladen

geschlossene Wände

geschlossene Wände

ART.			
F BG M3B0 01 04		key	1000
F BG S3B0 01 04		key	1000

ART.			
F BG M3B0 52 04		-	1000
F BG S3B0 52 04		-	1000

Komplett mit 4 "RK" ART. FP RK 5012 000 51 04, 12 "RK" ART. FP RK 6016 0000 51 04, 4 grauen Behälter COMPAT Gr. 4 ART. FP CO C004 B 00 51 01



4 Schubladen + 1 Tür

ART.				
F BG M3BC 00 04		-	1000	
F BG S3BC 00 04		-	1000	



2 Schubladen + 2 Türen

ART.				
F BG M3CC 00 04		key	1000	
F BG S3CC 00 04		key	1000	



4 Schubladen + 1 Tür

geschlossene Wände

ART.				
F BG M3BC 01 04		key	1000	
F BG S3BC 01 04		key	1000	

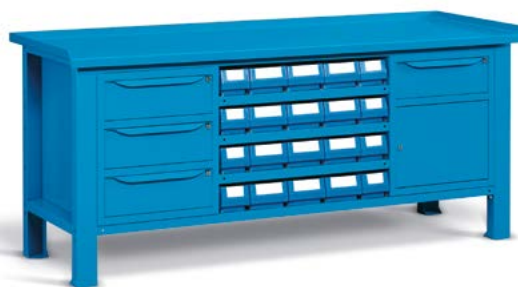

4 Schubladen + 1 Tür

geschlossene Wände

ART.				
F BG M3BC 52 04		key	1000	
F BG S3BC 52 04		key	1000	

Komplett mit 8 "RK" ART. FP RK 5012 000 51 04, 12 "RK" ART. FP RK 6016 0000 51 04



geschlossene Wände

ART.				
F BG M300 01 04		key	1000	
F BG S300 01 04		key	1000	



geschlossene Wände

ART.				
F BG M300 52 04		-	1000	
F BG S300 52 04		-	1000	

Komplett mit 4 "RK" ART. FP RK 5012 000 51 04, 18 "RK" ART. FP RK 6016 0000 51 04, 5 grauen Behälter COMPAT Gr. 4 ART. FP CO C004 B 00 51 01





● **ART. F BG M4B0 00 04**  
H = 855 mm - 3 Schubladen

 Farbauswahl STAHL



BLAU  
RAL 5012  
.04



GRAU  
RAL 7035  
.08

**OBERE PLATTE AUS STAHL**



KONFIGURIEREN SIE IHRE WERKBANK AB S. 775



RÜCKWANDAUFBAUTEN SIEHE S. 859

## ZEICHEN- ERKLÄRUNG



MONTIERTE  
WERKBANK



DEMONTIERTE  
WERKBANK



VERSCHLUSS



TRAGKRAFT  
DER  
WERKBANK

**!** DIE TRAGKRAFTANGABEN SIND NETTOANGABEN UND BEZIEHEN SICH AUF GLEICHMÄSSIG VERTEILTE GEWICHTE



ART.			
F BG M400 00 04		-	1000
F BG S400 00 04		-	1000



1 Schublade

ART.			
F BG M4A0 00 04		key	1000
F BG S4A0 00 04		key	1000



3 Schubladen

ART.			
● F BG M4B0 00 04		key	1000
F BG S4B0 00 04		key	1000



2 Schubladen

ART.			
F BG M4AA 00 04		key	1000
F BG S4AA 00 04		key	1000



4 Schubladen + 1 Tür

ART.			
F BG M4BC 00 04		key	1000
F BG S4BC 00 04		key	1000



8 Schubladen + 2 Türen

ART.			
F BG M4BC CB 04		key	1000
F BG S4BC CB 04		key	1000



4 Schubladen + 1 Tür

ART.			
F BG M4CB 01 04		key	1000
F BG S4CB 01 04		key	1000



4 Schubladen + 1 Tür

ART.			
F BG M4CB 52 04		key	1000
F BG S4CB 52 04		key	1000

Komplett mit 16 "RK" ART. FP RK 5012 000 51 04,  
16 "RK" ART. FP RK 6016 0000 51 04







● ART. F BG M5B0 00 04  
H = 880 mm - 3 Schubladen

 Farbauswahl STAHL



BLAU  
RAL 5012  
.04



GRAU  
RAL 7035  
.08

OBERE PLATTE AUS MULTIPLEX



KONFIGURIEREN SIE IHRE WERKBANK AB S. 775



RÜCKWANDAUFBAUTEN SIEHE S. 859

## ZEICHEN- ERKLÄRUNG



MONTIERTE  
WERKBANK



DEMONTIERTE  
WERKBANK



VERSCHLUSS



TRAGKRAFT  
DER  
WERKBANK

! DIE TRAGKRAFTANGABEN SIND NETTOANGABEN UND BEZIEHEN SICH AUF GLEICHMÄSSIG VERTEILTE GEWICHTE



ART.			
F BG M500 00 04		-	1000
F BG S500 00 04		-	1000



geschlossene Wände

ART.			
F BG M500 01 04		-	1000
F BG S500 01 04		-	1000



geschlossene Wände

ART.			
F BG M500 52 04		-	1000
F BG S500 52 04		-	1000

Komplett mit 4 "RK" ART. FP RK 5012 000 51 04,  
6 "RK" ART. FP RK 6016 0000 51 04 und 2 grauen Behälter COMPAT Gr. 4  
ART. FP CO C004 B 00 51 01



1 Schublade

ART.			
F BG M5A0 00 04		key	1000
F BG S5A0 00 04		key	1000



3 Schubladen

ART.			
● F BG M5B0 00 04		key	1000
F BG S5B0 00 04		key	1000



1 Schublade + 1 Tür

ART.			
F BG M5C0 00 04		key	1000
F BG S5C0 00 04		key	1000



● ART. F BG M6B0 00 04  
H = 880 mm - 3 Schubladen

 Farbauswahl STAHL



BLAU  
RAL 5012  
.04



GRAU  
RAL 7035  
.08

OBERE PLATTE AUS MULTIPLEX



KONFIGURIEREN SIE IHRE WERKBANK AB S. 775



RÜCKWANDAUFBAUTEN SIEHE S. 859

## ZEICHEN- ERKLÄRUNG



MONTIERTE  
WERKBANK



DEMONTIERTE  
WERKBANK



VERSCHLUSS



TRAGKRAFT  
DER  
WERKBANK

! DIE TRAGKRAFTANGABEN SIND NETTOANGABEN UND BEZIEHEN SICH AUF GLEICHMÄSSIG VERTEILTE GEWICHTE



ART.			
F BG M600 00 04		-	1000
F BG S600 00 04		-	1000



1 Schublade

ART.			
F BG M6A0 00 04		key	1000
F BG S6A0 00 04		key	1000



3 Schubladen

ART.			
● F BG M6B0 00 04		key	1000
F BG S6B0 00 04		key	1000



3 Schubladen

geschlossene Wände

ART.			
F BG M6B0 01 04		key	1000
F BG S6B0 01 04		key	1000



3 Schubladen

geschlossene Wände

ART.			
F BG M6B0 52 04		key	1000
F BG S6B0 52 04		key	1000

Komplett mit 4 "RK" ART. FP RK 5012 000 51 04, 6 "RK" ART. FP RK 6016 0000 51 04, 2 grauen Behälter COMPAT Gr. 4 ART. FP CO C004 B 00 51 01



4 Schubladen + 1 Tür

ART.			
F BG M6BC 00 04		key	1000
F BG S6BC 00 04		key	1000



● **ART. F BG M7B0 00 04**  
H = 880 mm - 3 Schubladen

 Farbauswahl STAHL



BLAU  
RAL 5012  
.04



GRAU  
RAL 7035  
.08

**OBERE PLATTE AUS MULTIPLEX**



KONFIGURIEREN SIE IHRE WERKBANK AB S. 775



RÜCKWANDAUFBAUTEN SIEHE S. 859

## ZEICHEN- ERKLÄRUNG



MONTIERTE  
WERKBANK



DEMONTIERTE  
WERKBANK



VERSCHLUSS



TRAGKRAFT  
DER  
WERKBANK

**!** DIE TRAGKRAFTANGABEN SIND NETTOANGABEN UND BEZIEHEN SICH AUF GLEICHMÄSSIG VERTEILTE GEWICHTE



ART.			kg
F BG M700 00 04		-	1000
F BG S700 00 04		-	1000



1 Schublade

ART.			kg
F BG M7A0 00 04		key	1000
F BG S7A0 00 04		key	1000



2 Schubladen

ART.			kg
F BG M7AA 00 04		key	1000
F BG S7AA 00 04		key	1000



3 Schubladen

ART.			kg
• F BG M7B0 00 04		key	1000
F BG S7B0 00 04		key	1000



3 Schubladen

geschlossene Wände

ART.			kg
F BG M7B0 01 04		key	1000
F BG S7B0 01 04		key	1000



3 Schubladen

geschlossene Wände

ART.			kg
F BG M7B0 52 04		key	1000
F BG S7B0 52 04		key	1000

Komplett mit 4 "RK" ART. FP RK 5012 000 51 04, 12 "RK" ART. FP RK 6016 0000 51 04, 4 grauen Behälter COMPAT Gr. 4 ART. FP CO C004 B 00 51 01



2 Schubladen + 1 Tür

ART.			
F BG M7AC 00 04		key	1000
F BG S7AC 00 04		key	1000



4 Schubladen + 1 Tür

ART.			
F BG M7BC 00 04		key	1000
F BG S7BC 00 04		key	1000



2 Schubladen + 2 Türen

ART.			
F BG M7CC 00 04		key	1000
F BG S7CC 00 04		key	1000



4 Schubladen + 1 Tür

geschlossene Wände

ART.			
F BG M7BC 01 04		key	1000
F BG S7BC 01 04		key	1000

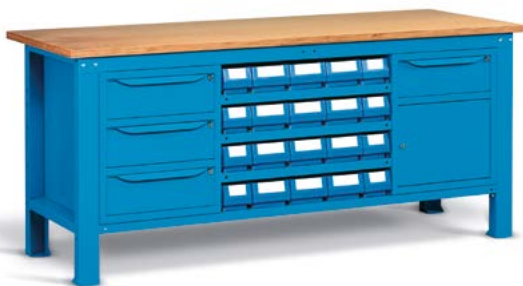

4 Schubladen + 1 Tür

geschlossene Wände

ART.			
F BG M7BC 52 04		key	1000
F BG S7BC 52 04		key	1000

Komplett mit 8 "RK" ART. FP RK 5012 000 51 04,  
12 "RK" ART. FP RK 6016 0000 51 04



geschlossene Wände

ART.			
F BG M700 52 04		-	1000
F BG S700 52 04		-	1000

Komplett mit 4 "RK" ART. FP RK 5012 000 51 04, 18 "RK" ART.  
FP RK 6016 0000 51 04, 5 grauen Behälter COMPAT Gr. 4  
ART. FP CO C004 B 00 51 01







● **ART. F BG M8B0 00 04**  
H = 880 mm – 3 Schubladen

 Farbauswahl STAHL



**OBERE PLATTE AUS MULTIPLEX**



KONFIGURIEREN SIE IHRE WERKBANK AB S. 775



RÜCKWANDAUFBAUTEN SIEHE S. 859

## ZEICHEN- ERKLÄRUNG



MONTIERTE  
WERKBANK



DEMONTIERTE  
WERKBANK



VERSCHLUSS



TRAGKRAFT  
DER  
WERKBANK

**!** DIE TRAGKRAFTANGABEN SIND NETTOANGABEN UND BEZIEHEN SICH AUF GLEICHMÄSSIG VERTEILTE GEWICHTE



ART.			
F BG M800 00 04		-	1000
F BG S800 00 04		-	1000



1 Schublade

ART.			
F BG M8A0 00 04		key	1000
F BG S8A0 00 04		key	1000



3 Schubladen

ART.			
● F BG M8B0 00 04		key	1000
F BG S8B0 00 04		key	1000



2 Schubladen

ART.			
F BG M8AA 00 04		key	1000
F BG S8AA 00 04		key	1000



4 Schubladen + 1 Tür

ART.			
F BG M8BC 00 04		key	1000
F BG S8BC 00 04		key	1000



8 Schubladen + 2 Türen

ART.			
F BG M8BC CB 04		key	1000
F BG S8BC CB 04		key	1000



4 Schubladen + 1 Tür

ART.			
F BG M8CB 01 04		key	1000
F BG S8CB 01 04		key	1000



4 Schubladen + 1 Tür

ART.			
F BG M8CB 52 04		key	1000
F BG S8CB 52 04		key	1000

Komplett mit 16 "RK" ART. FP RK 5012 000 51 04,  
16 "RK" ART. FP RK 6016 0000 51 04



## KONFIGURIEREN SIE IHRE WERKBANK



### OBERE PLATTE AUS STAHL

ART.	Abm. mm	kg
F BG 3110 00 04	1031x705x32 H	1000
F BG 3115 00 04	1507x705x32 H	1000
F BG 3120 00 04	2000x705x32 H	1000
F BG 3125 00 04	2507x705x32 H	1000



### OBERE PLATTE AUS MULTIPLEX

ART.	Abm. mm	kg
F BI A014 02 00	1024x750x30 H	1000
F BI A042 02 00	1500x750x30 H	1000
F BI A070 02 00	2000x750x30 H	1000
F BI A084 02 00	2500x750x30 H	1000

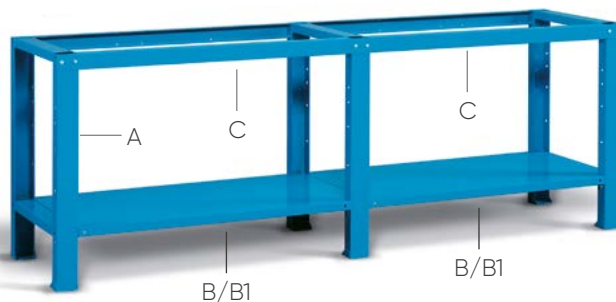
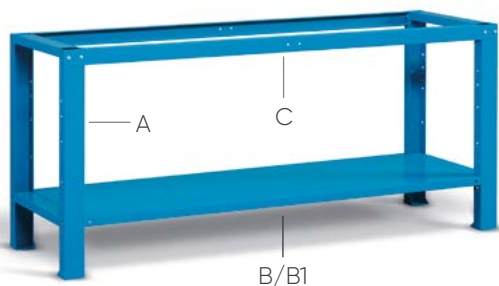

### BEIN, TRAVERSEN, UNTERE BÖDEN

ART.	Beschreibung	Abm. mm	Werkbankbreite mm	Bez.	kg
F BG 3000 00 04	Bein	80x610x852 H	-	A	-
F BG 3308 00 04	Boden ohne Schlitz aus Stahl	760x600x35 H	1031/1024	B	250
F BG 3408 00 04	Boden mit Schlitz aus Stahl	760x600x35 H	1031/1024	B1	60
F BG 3510 01 04	Paar obere Traversen	915x60x48 H	1031/1024	C	-
F BG 3313 00 04	Boden ohne Schlitz aus Stahl	1260x600x35 H	1507/1500	B	250
F BG 3413 00 04	Boden mit Schlitz aus Stahl	1260x600x35 H	1507/1500	B1	60
F BG 3515 01 04	Paar obere Traversen	1415x60x48 H	1507/1500	C	-
F BG 3318 00 04	Boden ohne Schlitz aus Stahl	1760x600x35 H	2007/2000	B	200
F BG 3418 00 04	Boden mit Schlitz aus Stahl	1760x600x35 H	2007/2000	B1	60
F BG 3520 01 04	Paar obere Traversen	1915x60x48 H	2007/2000	C	-
F BG 3311 00 04	Boden ohne Schlitz aus Stahl	1090x600x35 H	2507/2500	B	250
F BG 3411 00 04	Boden mit Schlitz aus Stahl	1090x600x35 H	2507/2500	B1	60
F BG 3525 01 04	Paar obere Traversen	2415x60x48 H	2507/2500	D	-



#### ART. F BG 3999 00 00

DIE VORMONTAGE WIRD BEI ALLEN  
EINZELNEN KOMPONENTEN  
ANGERECHNET





## ABDECKPLATTE FÜR BÖDEN AUS STAHL

ART.	Abm. mm
<b>F BG 3210 00 07</b>	1024x700x27 H
<b>F BG 3215 00 07</b>	1500x700x27 H
<b>F BG 3220 00 07</b>	2000x700x27 H
<b>F BG 3225 00 07</b>	2500x700x27 H

Abdeckung Dicke 8/10 - 12/10 - 15/10 mm Stahl mit ölfester Gummiverklebung für Stahlplatten und vorne mit „L“-Form H 27 mm



## ABDECKPLATTE FÜR BÖDEN AUS MULTIPLEX

ART.	Abm. mm
<b>F BL 2230 00 07</b>	1024x750x20 H
<b>F BL 2260 00 07</b>	1500x750x20 H
<b>F BL 2290 00 07</b>	2000x750x20 H
<b>F BL 2305 00 07</b>	2500x750x20 H

Abdeckung Dicke 8/10 - 12/10 - 15/10 mm Stahl mit ölfester Gummiverklebung für Multiplex-Platten, hinten und vorne mit „L“-Form H 20 mm



## VERZINKTE ABDECKPLATTE FÜR BÖDEN AUS MULTIPLEX

ART.	Abm. mm
<b>F BL 7900 00 99</b>	1024x750x20 H
<b>F BL 7930 00 99</b>	1500x750x20 H
<b>F BL 7960 00 99</b>	2000x750x20 H
<b>F BL 7975 00 99</b>	2500x750x20 H

Abdeckung Dicke 12/10 mm aus Stahl mit Mikrolochung für Multiplex-Platten, hinten und vorne mit „L“-Form H 20 mm, abriebfest sowie öl- und fettbeständig

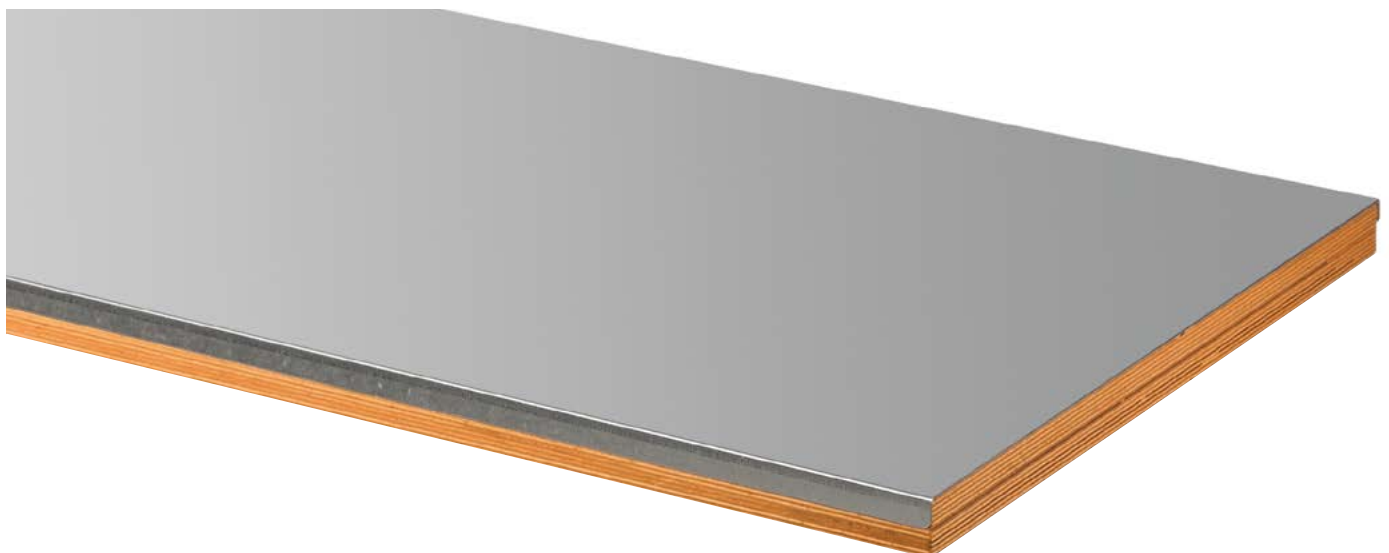



ART.	Abm. mm
<b>F BG 3030 01 04</b>	500x607x570 H

Tragkraft Schublade 25 kg

ART.	Abm. mm
<b>F BG 3050 01 04</b>	500x607x570 H

Tragkraft Schublade 25 kg

ART.	Abm. mm
<b>F BG 3010 01 04</b>	500x607x210 H

Tragkraft Schublade 25 kg



### ART. F BG 3999 00 00

DIE VORMONTAGE WIRD BEI ALLEN EINZELNEN KOMPONENTEN ANGERECHNET

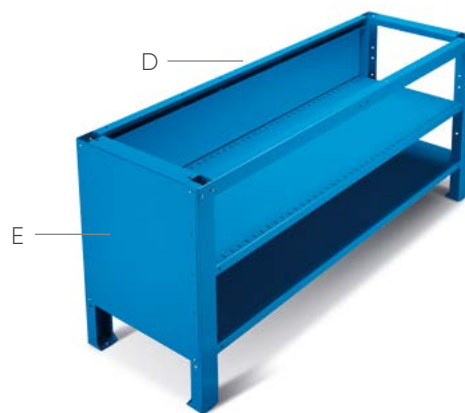

### SEITEN- UND RÜCKENWÄNDE

ART.	Beschreibung	Abm. mm	Werkbankbreite mm	Bez.
<b>F BG 3690 00 04</b>	Seitenwand	590x660 H	-	E
<b>F BG 3608 00 04</b>	Rückenwand	840x48x653 H	1031/1024	D
<b>F BG 3613 00 04</b>	Rückenwand	1340x48x653 H	1507/1500	D
<b>F BG 3618 00 04</b>	Rückenwand	1840x48x653 H	2007/2000	D
<b>F BG 3611 00 04</b>	Einzelne Rückenwand für Regalfeld	1170x48x653 H	2507/2500	D



### BÖDEN MIT UND OHNE SCHLITZEN AUS STAHL

ART.	Beschreibung	Abm. mm	Tragkraft kg	Bez.
<b>F BG 3308 00 04</b>	Boden ohne Schlitz aus Stahl	760x600x35 H	60	F
<b>F BG 3408 00 04</b>	Boden mit Schlitz aus Stahl	760x600x35 H	60	F1
<b>F BG 3313 00 04</b>	Boden ohne Schlitz aus Stahl	1260x600x35 H	60	G
<b>F BG 3413 00 04</b>	Boden mit Schlitz aus Stahl	1260x600x35 H	60	G1
<b>F BG 3406 00 04</b>	Boden mit Schlitz aus Stahl	590x600x35 H	60	H



